

**DISCRETE  
DATABOOK**

---

**NATIONAL  
SEMICONDUCTOR**

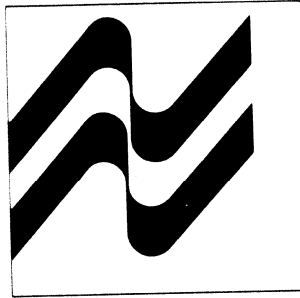



# **DISCRETE DATABOOK**

---

## **NATIONAL SEMICONDUCTOR**

**NPN Transistors**

**PNP Transistors**

**Pro Electron Series**

**JEIDA Series**

**NA/NB/NR Series**

**Process Characteristics**

**Double-Diffused Epitaxial Transistors**

**Process Characteristics Mesa Transistors**

**JFET Selection Guide**

**Process Characteristics JFETs**

**1**

**2**

**3**

**4**

**5**

**6**

**7**

**8**

**9**

© **National Semiconductor Corporation**  
2900 Semiconductor Drive, Santa Clara, California 95051,  
(408) 737-5000/TWX (910) 339-9240

National does not assume any responsibility for use of any circuitry  
described; no circuit patent licenses are implied, and National  
reserves the right, at any time without notice, to change said circuitry.

Manufactured under one or more of the following U.S. patents:  
3083262, 3189758, 3231797, 3303356, 3317671, 3323071,  
3381071, 3408542, 3421025, 3426423, 3440498, 3518750,  
3519897, 3557431, 3560765, 3566218, 3571630, 3575609,  
3579059, 3593069, 3597640, 3607469, 3617859, 3631312,  
3633052, 3638131, 3648071, 3651565, 3693248.

# Introduction

National Semiconductor has added many new transistors and product families since publication of the last handbook. Many have already been widely acclaimed by users.

In addition to small signal, bipolar and field effect transistors that have been the mainstay of our catalog, there are sections for multiple bipolar, multiple field effect and power transistors. More part numbers will be added as market needs expand.

To keep current on all new National transistors please contact your National sales representative or franchised distributor and ask to be placed on the customer mailing list.

## HOW TO USE THIS CATALOG

If you know the part/type number

Turn to the standard parts listing which begins on page 9 and find the desired part number. The electrical specifications page number will be shown. The list also identifies the process number from which that product is selected and the particular package code in which it is assembled. Package codes are cross-referenced to JEDEC code on page A-19.

If performance data is required, turn to the process data sheet indicated in the standard parts listing. Process data sheets are indexed in numerical order and begin on page 6-2.

Refer to the package outlines section beginning on page A-14 for complete physical dimensions.

If you know the application

Turn to the selector guide and select a potential process type. Selector guides as follows:

GUIDE	PAGE
RF Selector . . . . .	41
NPN General Purpose Amplifiers . . . . .	42
PNP General Purpose Amplifiers . . . . .	44
NPN-RF Amplifier . . . . .	43
High Speed Switches . . . . .	45
Power Transistors . . . . .	46
FET Application . . . . .	30

Refer to the process sheet which will give you the performance specifications and a reference part type.

To convert a metal can transistor to a molded epoxy type, find the equivalent part number on page 25.

To convert a TO-105/TO-106 product type to a molded epoxy type, find the correct part number on page 26.

If you are looking for a JAN/JANTX/JANTXV type, a complete product listing for bipolar and junction FET types is on page 23.

If none of the above work, refer to the Table of Contents which contains all NSC part types organized by general applications.

In desperation—call your local National representative or field office.



# Table of Contents

Introduction — How to Use This Catalog .....	3
Transistor Standard Parts List .....	9
FET Parts List .....	20
MIL-STD Qualifications .....	23
Bipolar Transistor and FET Dice .....	24
Bipolar Transistor Equivalents List .....	25
Conversion of TO-105/TO-106 to TO-92 .....	26
Choose the Proper FET .....	29
FET Application Guide .....	30
JFET Cross-Reference Guide .....	33
RF Selector Guide .....	41
Transistors NPN GPA Devices .....	42
Transistors NPN RF Devices .....	43
Transistors PNP GPA Devices .....	44
Transistors for High Speed Switching .....	45
Power Transistor Selector Guide .....	46
Power Transistor Part Number Listing .....	47
92+ Power Transistor Reference Guide .....	48
TO-202 Power Transistor Reference Guide .....	49
TO-126 Power Transistor Reference Guide .....	50
TO-220 Power Transistor Reference Guide .....	51
TO-3 Power Transistor Reference Guide .....	52

## Section 1—NPN Transistors

Saturated Switches .....	1-2
RF Amps and Oscillators .....	1-6
Low Level Amps .....	1-11
General Purpose Amps and Switches .....	1-15
Medium Power .....	1-28
Power .....	1-40
Darlington .....	1-50
Dual Differential Amps .....	1-51

## Section 2—PNP Transistors

Saturated Switches .....	2-2
Low Level Amps .....	2-6
General Purpose Amps and Switches .....	2-8
Medium Power .....	2-19
Power .....	2-26
Dual Differential Amps .....	2-33

## Section 3—Pro Electron Series

Pro Electron Series .....	3-2
---------------------------	-----

## Section 4—JEIDA Series

JEIDA Series .....	4-2
--------------------	-----

# Table of Contents (Continued)

## Section 5—NA/NB/NR Series

NA/NB Transistor Series Selection Guide . . . . .	5-2
NA01 (NPN), NA02 (PNP) 800 mA Complementary Power Transistors . . .	5-4
NA11 (NPN), NA12 (PNP) 1 Amp Complementary Power Transistors . . . .	5-8
NA21 (NPN), NA22 (PNP) 1.5 Amp Complementary Power Transistors . . .	5-12
NA31 (NPN), NA32 (PNP) 2 Amp Complementary Power Transistors . . . .	5-16
NA41 (NPN), NA42 (PNP) 2.5 Amp Complementary Power Transistors . . .	5-20
NA51 (NPN), NA52 (PNP) 3.5 Amp Complementary Power Transistors . . .	5-24
NA61 (NPN), NA62 (PNP) 4.5 Amp Complementary Power Transistors . . .	5-28
NA71 (NPN), NA72 (PNP) 3.5 Amp Complementary Power Transistors . . .	5-32
NB011, 012 (NPN), NB021, 022 (PNP) 30 mA General Purpose Transistors . . . . .	5-36
NB013, 014 (NPN), NB023, 024 (PNP) 30 mA Low Noise Transistors . . . .	5-40
NB111, 112, 113 (NPN), NB121, 122, 123 (PNP) 100 mA General Purpose Transistors . . . . .	5-44
NB211, 212, 213 (NPN), NB221, 222, 223 (PNP) 500 mA Medium Current Driver Transistors . . . . .	5-48
NB311, 312, 313 (NPN), NB321, 322, 323 (PNP) 1.5 Amp Complementary Power Drivers . . . . .	5-52
NR421 (NPN) VHF Amplifier/FM Converter Transistor . . . . .	5-56
NR431 (NPN) HF Amplifier/FM Converter Transistor . . . . .	5-60
NR461 (NPN) Low-Noise RF/IF Transistor . . . . .	5-64
NR041 (NPN) Low-Level Signal Switching Transistor . . . . .	5-68

## Section 6—Process Characteristics

### Double-Diffused Epitaxial Transistors

Process 02 NPN Small Signal . . . . .	6-2
Process 04 NPN Small Signal . . . . .	6-4
Process 05 NPN Darlington . . . . .	6-7
Process 07 NPN Small Signal . . . . .	6-9
Process 08 NPN High Voltage . . . . .	6-12
Process 09 NPN Medium Power . . . . .	6-14
Process 12 NPN Medium Power . . . . .	6-16
Process 13 NPN Medium Power . . . . .	6-19
Process 14 NPN Medium Power . . . . .	6-22
Process 16 NPN High Voltage . . . . .	6-24
Process 19 NPN Medium Power . . . . .	6-26
Process 20 NPN Medium Power . . . . .	6-28
Process 21 NPN High Speed Switch . . . . .	6-31
Process 22 NPN Small Signal . . . . .	6-35
Process 23 NPN Small Signal . . . . .	6-39
Process 25 NPN Memory Driver . . . . .	6-42
Process 27 NPN Small Signal . . . . .	6-45
Process 29 NPN HF Amp . . . . .	6-48
Process 35 NPN RF-HF Power Amplifier . . . . .	6-50
Process 36 NPN High Voltage Power . . . . .	6-52
Process 37 NPN Medium Power . . . . .	6-54



# Table of Contents (Continued)

## Section 6—Process Characteristics

### Double-Diffused Epitaxial Transistors (Continued)

Process 38 NPN Medium Power.....	6-56
Process 39 NPN Medium Power.....	6-58
Process 41 NPN AGC-UHF, Amp Mixer.....	6-60
Process 42 NPN RF Amp.....	6-62
Process 43 NPN VHF/UHF Oscillator.....	6-65
Process 44 NPN AGC-RF Amp.....	6-68
Process 45 NPN AGC-IF Amp.....	6-73
Process 46 NPN RF-IF Amp.....	6-77
Process 47 NPN RF-IF Amp.....	6-80
Process 48 NPN High Voltage Video Output.....	6-84
Process 49 NPN RF Amp.....	6-86
Process 60 PNP Medium Power.....	6-89
Process 62 PNP Small Signal.....	6-92
Process 63 PNP Medium Power.....	6-95
Process 64 PNP High Speed Switch.....	6-98
Process 65 PNP High Speed Switch.....	6-102
Process 66 PNP Small Signal.....	6-105
Process 67 PNP Medium Power.....	6-108
Process 69 PNP Small Signal.....	6-110
Process 70 PNP Memory Driver.....	6-113
Process 71 PNP Small Signal.....	6-116
Process 73 PNP High Voltage.....	6-118
Process 74 PNP High Voltage.....	6-120
Process 77 PNP Medium Power.....	6-122
Process 78 PNP Medium Power.....	6-124
Process 79 PNP Medium Power.....	6-126

## Section 7—Process Characteristics Mesa Transistors

Process 2C/4F NPN Epitaxial Power.....	7-2
Process 2E/4E NPN Epitaxial Power.....	7-4
Process 2J/4J NPN Power Darlington.....	7-6
Process 3C/5F PNP Epitaxial Power.....	7-8
Process 3E/5E PNP Epitaxial Power.....	7-10
Process 3J/5J PNP Power Darlington.....	7-12
Process 4A NPN Epitaxial Power.....	7-14
Process 4B NPN Epitaxial Power.....	7-16
Process 4C NPN Epitaxial Power.....	7-18
Process 4G NPN Epitaxial Power.....	7-20
Process 4K NPN Epitaxial Power.....	7-21
Process 5A PNP Epitaxial Power.....	7-23
Process 5B PNP Epitaxial Power.....	7-25
Process 5C PNP Epitaxial Power.....	7-27
Process 5G PNP Epitaxial Power.....	7-29
Process 5K PNP Epitaxial Power.....	7-30

# Table of Contents (Continued)

## Section 8—JFET Selection Guide

JFET Selection Guide .....	8-2
----------------------------	-----

## Section 9—Process Characteristics JFETs

Process 50 N-Channel JFET .....	9-2
Process 51 N-Channel JFET .....	9-5
Process 52 N-Channel JFET .....	9-7
Process 53 N-Channel JFET .....	9-9
Process 55 N-Channel JFET .....	9-11
Process 58 N-Channel JFET .....	9-13
Process 83 N-Channel Monolithic Dual JFET .....	9-15
Process 84 N-Channel Monolithic Dual JFET .....	9-17
Process 86* N-Channel Monolithic Dual JFET .....	9-19
Process 88 P-Channel JFET .....	9-20
Process 89 P-Channel JFET .....	9-22
Process 90 N-Channel JFET .....	9-24
Process 92 N-Channel JFET .....	9-26
Process 93 N-Channel Monolithic Dual JFET .....	9-28
Process 94 N-Channel Monolithic Dual JFET .....	9-30
Process 95 N-Channel Monolithic Dual JFET .....	9-32
Process 96 N-Channel Monolithic Dual JFET .....	9-34
Process 98* N-Channel Monolithic Dual JFET .....	9-36

## Appendices

Transistor Glossary of Symbols .....	A-2
JFET Glossary of Symbols .....	A-9
Package Outlines .....	A-14
NSC Package Code to JEDEC Code .....	A-19

\*Process in development

# Transistor Standard Parts List

Device	Page	Process	Pkg.	Device	Page	Process	Pkg.	Device	Page	Process	Pkg.
2N697	1-15	20	04	2N2219JTX	1-16	20	04	2N2722	1-51	07	30
2N699	1-28	12	10	2N2219JTXV	1-16	20	04	2N2857	1-6	42	25
2N706	1-2	21	18	2N2219A	1-16	20	04	2N2857J	1-6	42	25
2N706J	1-2	21	02	2N2219AJ	1-16	20	04	2N2857JTX	1-6	42	25
2N708	1-2	22	18	2N2219AJTX	1-16	20	04	2N2857JTXV	1-6	42	25
2N718	1-15	20	02	2N2219AJTXV	1-16	20	04	2N2894	2-2	64	18
2N718A	1-15	20	02	2N2221	1-16	20	02	2N2894A	2-2	64	18
2N722	2-8	63	02	2N2221J	1-17	20	02	2N2903	1-51	07	30
2N743	1-2	21	18	2N2221JTX	1-17	20	02	2N2903A	1-51	07	30
2N744	1-2	21	18	2N2221JTXV	1-17	20	02	2N2904	2-9	63	04
2N753	1-2	21	18	2N2221A	1-17	20	02	2N2904J	2-9	63	04
2N760	1-11	07	02	2N2221AJ	1-17	20	02	2N2904JTX	2-9	63	04
2N760A	1-11	07	02	2N2221AJTX	1-17	20	02	2N2904JTXV	2-9	63	04
2N834	1-2	21	18	2N2221AJTXV	1-17	20	02	2N2904A	2-9	63	04
2N869	2-2	64	18	2N2222	1-17	20	02	2N2904AJ	2-9	63	04
2N869A	2-2	64	18	2N2222J	1-17	20	02	2N2905AJTX	2-9	63	04
2N915	1-15	23	02	2N2222JTX	1-17	20	02	2N2905AJTXV	2-9	63	04
2N916	1-15	23	02	2N2222JTXV	1-17	20	02	2N2905	2-9	63	04
2N917	1-6	43	25	2N2222A	1-17	20	02	2N2905J	2-9	63	04
2N918	1-6	43	25	2N2222AJ	1-17	20	02	2N2905JTX	2-9	63	04
2N918J	1-6	43	25	2N2222AJTX	1-17	20	02	2N2905JTXV	2-9	63	04
2N918JTX	1-6	43	25	2N2222AJTXV	1-17	20	02	2N2905A	2-9	63	04
2N918JTXV	1-6	43	25	2N2243	1-29	12	10	2N2905AJ	2-10	63	04
2N929	1-11	07	02	2N2243A	1-29	12	10	2N2905AJTX	2-10	63	04
2N929A	1-11	07	02	2N2270	1-29	12	10	2N2905AJTXV	2-10	63	04
2N929J	1-11	07	02	2N2369	1-2	21	18	2N2906	2-10	63	02
2N929JTX	1-11	07	02	2N2369A	1-2	21	18	2N2906J	2-10	63	02
2N930	1-11	07	02	2N2369AJ	1-2	21	02	2N2906JTX	2-10	63	02
2N930A	1-11	07	02	2N2369AJTX	1-2	21	02	2N2906JTXV	2-10	63	02
2N930J	1-11	07	02	2N2369AJTXV	1-2	21	02	2N2906A	2-10	63	02
2N930JTX	1-11	07	02	2N2453	1-51	07	30	2N2906AJ	2-10	63	02
2N956	1-15	20	02	2N2453A	1-51	07	30	2N2906AJTX	2-10	63	02
2N981	1-11	07	02	2N2484	1-11	07	02	2N2906AJTXV	2-10	63	02
2N995	2-2	64	18	2N2484J	1-11	07	02	2N2907	2-10	63	02
2N995A	2-2	64	18	2N2484JTX	1-11	07	02	2N2907J	2-10	63	02
2N1132	2-8	63	04	2N2484JTXV	1-11	07	02	2N2907JTX	2-10	63	02
2N1420	1-15	20	04	2N2504	1-12	07	02	2N2907JTXV	2-10	63	02
2N1566	1-15	20	04	2N2509	1-11	07	02	2N2907A	2-10	63	02
2N1613	1-15	20	04	2N2510	1-11	07	02	2N2907AJ	2-11	63	02
2N1711	1-15	20	04	2N2511	1-12	07	06	2N2907AJTX	2-11	63	02
2N2017	1-28	12	10	2N2586	1-12	07	02	2N2907AJTXV	2-11	63	02
2N2102	1-28	12	10	2N2604	2-6	62	06	2N2913	1-51	07	30
2N2192	1-28	12	10	2N2604J	2-6	62	06	2N2914	1-51	07	30
2N2192A	1-28	12	10	2N2604JTX	2-6	62	06	2N2915	1-52	07	30
2N2193	1-28	12	10	2N2604JTXV	2-6	62	06	2N2915A	1-52	07	30
2N2193A	1-28	12	10	2N2605	2-6	62	06	2N2916	1-52	07	30
2N2195	1-28	12	10	2N2605J	2-6	62	06	2N2916A	1-52	07	30
2N2195A	1-28	12	10	2N2605JTX	2-6	62	06	2N2917	1-52	07	30
2N2218	1-15	20	04	2N2605JTXV	2-6	62	06	2N2918	1-52	07	30
2N2218J	1-15	20	04	2N2639	1-51	07	30	2N2919	1-52	07	30
2N2218JTX	1-15	20	04	2N2640	1-51	07	30	2N2919A	1-52	07	30
2N2218JTXV	1-15	20	04	2N2641	1-51	07	30	2N2920	1-52	07	30
2N2218A	1-16	20	04	2N2642	1-51	07	30	2N2920J	1-52	07	30
2N2218AJ	1-16	20	04	2N2643	1-51	07	30	2N2920JTX	1-52	07	30
2N2218AJTX	1-16	20	04	2N2644	1-51	07	30	2N2920JTXV	1-52	07	27
2N2218AJTXV	1-16	20	04	2N2696	2-8	63	02	2N2920A	1-52	07	30
2N2219	1-16	20	04	2N2712	1-17	27	74	2N2923	1-18	04	74
2N2219J	1-16	20	04	2N2714	1-18	27	74	2N2924	1-18	04	74

## Transistor Standard Parts List (Continued)

Device	Page	Process	Pkg.	Device	Page	Process	Pkg.	Device	Page	Process	Pkg.
2N2925	1-18	04	74	2N3302	1-18	20	02	2N3568	1-31	12	72
2N2926	1-18	04	74	2N3304	2-3	65	18	2N3569	1-31	14	72
2N2972	1-52	07	08	2N3347	2-33	62	30	2N3576	2-3	64	18
2N2973	1-52	07	08	2N3348	2-33	62	30	2N3587	1-53	07	30
2N2974	1-53	07	08	2N3349	2-33	62	30	2N3600	1-7	42	25
2N2975	1-53	07	08	2N3350	2-33	62	30	2N3605	1-3	21	74
2N2976	1-53	07	08	2N3351	2-33	62	30	2N3606	1-3	21	74
2N2977	1-53	07	08	2N3352	2-33	62	30	2N3607	1-3	21	74
2N2978	1-53	07	08	2N3390	1-18	04	74	2N3634	2-19	73	10
2N2979	1-53	07	08	2N3391	1-18	04	74	2N3634J	2-19	73	09
2N3009	1-2	22	18	2N3391A	1-19	04	74	2N3634JTX	2-19	73	09
2N3011	1-2	21	18	2N3392	1-19	04	74	2N3635	2-19	73	10
2N3012	2-2	64	18	2N3393	1-19	04	74	2N3635	2-19	73	09
2N3013	1-2	22	18	2N3394	1-19	04	74	2N3635JTX	2-19	73	09
2N3015	1-2	25	17	2N3395	1-19	04	74	2N3636	2-19	73	10
2N3019	1-29	12	10	2N3396	1-19	04	74	2N3636J	2-19	73	09
2N3019J	1-29	12	09	2N3397	1-19	04	74	2N3636JTX	2-19	73	09
2N3019JTX	1-29	12	09	2N3398	1-19	04	74	2N3637	2-19	73	10
2N3019JTXV	1-29	12	16	2N3414	1-19	19	74	2N3637J	2-19	73	09
2N3020	1-30	12	10	2N3415	1-19	04	74	2N3637JTX	2-19	73	09
2N3053	1-30	12	10	2N3416	1-19	04	74	2N3638	2-12	63	72
2N3072	2-11	63	04	2N3417	1-19	04	74	2N3638A	2-13	63	72
2N3073	2-11	63	02	2N3444	1-3	25	17	2N3639	2-3	65	72
2N3107	1-30	12	10	2N3451	2-3	65	18	2N3640	2-3	65	72
2N3108	1-30	12	10	2N3467	2-3	70	17	2N3641	1-19	19	72
2N3109	1-30	12	10	2N3468	2-3	70	17	2N3642	1-19	19	72
2N3110	1-30	14	10	2N3478	1-6	42	25	2N3643	1-19	19	72
2N3114	1-30	08	10	2N3498	1-30	08	10	2N3644	2-13	63	72
2N3115	1-18	20	02	2N3498J	1-30	08	09	2N3646	1-3	22	72
2N3116	1-18	20	02	2N3498JTX	1-30	08	09	2N3662	1-7	43	74
2N3117	1-12	07	02	2N3498JTXV	1-30	08	09	2N3663	1-7	43	74
2N3120	2-11	63	04	2N3499	1-30	08	10	2N3665	1-31	12	10
2N3121	2-11	63	02	2N3499J	1-31	08	09	2N3666	1-32	12	10
2N3133	2-11	63	04	2N3499JTX	1-31	08	09	2N3678	1-19	20	04
2N3134	2-11	63	04	2N3499JTXV	1-31	08	09	2N3691	1-20	23	72
2N3135	2-11	63	02	2N3500	1-31	08	10	2N3692	1-20	23	72
2N3136	2-11	63	02	2N3500J	1-31	08	09	2N3693	1-20	27	72
2N3209	2-2	64	18	2N3500JTX	1-31	08	09	2N3694	1-20	27	72
2N3244	2-2	70	17	2N3500JTXV	1-31	08	09	2N3700	1-32	12	02
2N3245	2-2	70	17	2N3501	1-31	08	10	2N3700J	1-32	12	02
2N3246	1-12	07	02	2N3501J	1-31	08	09	2N3700JTX	1-32	12	02
2N3248	2-2	64	18	2N3501JTX	1-31	08	09	2N3700JTXV	1-32	12	02
2N3249	2-2	64	18	2N3501JTXV	1-31	08	09	2N3702	2-13	63	74
2N3250	2-11	69	02	2N3502	2-12	63	04	2N3703	2-13	63	74
2N3250A	2-11	69	02	2N3503	2-12	63	04	2N3704	1-20	13	74
2N3250AJ	2-12	69	02	2N3504	2-12	63	02	2N3705	1-20	13	74
2N3250AJTX	2-12	69	02	2N3505	2-12	63	02	2N3706	1-20	13	74
2N3250AJTXV	2-12	69	02	2N3545	2-3	64	18	2N3707	1-12	07	74
2N3251	2-12	69	02	2N3546	2-3	64	18	2N3708	1-12	07	74
2N3251A	2-12	69	02	2N3547	2-6	62	02	2N3709	1-12	07	74
2N3251AJ	2-12	69	02	2N3548	2-6	62	02	2N3710	1-12	07	74
2N3251AJTX	2-12	69	02	2N3549	2-6	62	02	2N3711	1-12	07	74
2N3251AJTXV	2-12	69	02	2N3550	2-6	62	02	2N3721	1-20	27	74
2N3252	1-2	25	17	2N3563	1-7	43	72	2N3724	1-3	25	17
2N3253	1-3	25	17	2N3564	1-7	43	72	2N3724A	1-3	25	17
2N3299	1-18	20	04	2N3565	1-12	07	72	2N3725	1-3	25	17
2N3300	1-18	20	04	2N3566	1-31	14	72				
2N3301	1-18	20	02	2N3567	1-31	14	72				

## Transistor Standard Parts List (Continued)

Device	Page	Process	Pkg.	Device	Page	Process	Pkg.	Device	Page	Process	Pkg.
2N3725A	1-4	25	17	2N4023	2-36	62	30	2N4400	1-21	13	72
2N3726	2-33	62	30	2N4024	2-36	62	30	2N4401	1-21	13	72
2N3727	2-33	62	30	2N4025	2-36	62	30	2N4402	2-14	63	72
2N3742	1-32	48	10	2N4030	2-20	67	10	2N4403	2-14	63	72
2N3793	1-20	13	74	2N4031	2-20	67	10	2N4409	1-13	07	72
2N3794	1-20	13	74	2N4032	2-20	67	10	2N4410	1-13	07	72
2N3799	2-6	62	02	2N4033	2-20	67	10	2N4424	1-26	04	74
2N3800	2-34	62	08	2N4036	2-20	67	10	2N4916	2-14	66	72
2N3806	2-34	62	30	2N4037	2-20	67	10	2N4917	2-14	66	72
2N3807	2-34	62	30	2N4047	1-4	25	17	2N4918	2-26	3C	38
2N3808	2-34	62	30	2N4058	2-7	62	74	2N4919	2-26	3C	38
2N3809	2-34	62	30	2N4059	2-7	62	74	2N4920	2-26	3C	38
2N3810	2-34	62	30	2N4061	2-7	62	74	2N4921	1-40	2C	38
2N3810J	2-34	62	30	2N4062	2-7	62	74	2N4922	1-40	2C	38
2N3810JTX	2-34	62	30	2N4121	2-13	66	72	2N4923	1-40	2C	38
2N3810JTXV	2-34	62	30	2N4122	2-13	66	72	2N4924	1-32	12	10
2N3810A	2-35	62	30	2N4123	1-21	23	72	2N4926	1-32	48	10
2N3811	2-35	62	30	2N4124	1-21	23	72	2N4927	1-32	48	10
2N3811J	2-35	62	30	2N4125	2-13	66	72	2N4944	1-26	19	72
2N3811JTX	2-35	62	30	2N4126	2-13	66	72	2N4945	1-26	19	72
2N3811JTXV	2-35	62	30	2N4134	1-7	44	25	2N4946	1-26	19	72
2N3811A	2-35	62	30	2N4140	1-21	19	72	2N4951	1-26	13	74
2N3825	1-7	43	74	2N4141	1-21	19	72	2N4952	1-26	13	74
2N3827	1-20	27	74	2N4142	2-13	63	72	2N4953	1-26	13	74
2N3858	1-20	27	74	2N4143	2-13	63	72	2N4954	1-26	13	74
2N3858A	1-12	07	74	2N4208	2-3	65	18	2N4964	2-8	62	72
2N3859	1-20	27	74	2N4209	2-3	65	18	2N4965	2-8	62	72
2N3859A	1-12	07	74	2N4234	2-20	67	10	2N4966	1-13	07	72
2N3860	1-20	27	74	2N4235	2-20	67	10	2N4967	1-13	07	72
2N3877	1-12	07	74	2N4236	2-20	67	10	2N4968	1-13	07	72
2N3877A	1-13	07	74	2N4237	1-32	14	10	2N4969	1-26	19	72
2N3900	1-13	07	74	2N4248	2-7	62	72	2N4970	1-26	19	72
2N3900A	1-13	07	74	2N4249	2-7	62	72	2N4971	2-14	63	72
2N3901	1-13	07	74	2N4250	2-7	62	72	2N4972	2-14	63	72
2N3903	1-20	23	72	2N4250A	2-7	62	72	2N5022	2-4	70	17
2N3904	1-20	23	72	2N4252	1-7	42	25	2N5023	2-4	70	17
2N3905	2-13	66	72	2N4258	2-3	65	72	2N5030	1-4	21	74
2N3906	2-13	66	72	2N4258A	2-3	65	72	2N5056	2-4	64	18
2N3907	1-53	07	30	2N4259	1-7	42	25	2N5057	2-4	64	18
2N3908	1-53	07	30	2N4274	1-4	21	72	2N5086	2-8	62	72
2N3932	1-7	42	25	2N4275	1-4	21	72	2N5087	2-8	62	72
2N3933	1-7	42	25	2N4286	1-13	07	74	2N5088	1-13	07	72
2N3945	1-32	12	10	2N4287	1-13	07	74	2N5089	1-13	07	72
2N3946	1-21	23	02	2N4288	2-7	62	74	2N5127	1-26	27	72
2N3947	1-21	23	02	2N4289	2-7	62	74	2N5128	1-26	19	72
2N3962	2-6	62	02	2N4290	2-13	63	74	2N5129	1-26	19	72
2N3963	2-7	62	02	2N4291	2-14	63	74	2N5130	1-7	43	72
2N3964	2-7	62	02	2N4292	1-7	43	74	2N5131	1-26	27	72
2N3965	2-7	62	02	2N4293	1-7	43	74	2N5132	1-26	27	72
2N4013	1-4	25	02	2N4294	1-4	21	74	2N5133	1-13	07	72
2N4014	1-4	25	02	2N4295	1-4	21	74	2N5134	1-4	21	72
2N4015	2-35	62	30	2N4314	2-20	67	10	2N5135	1-26	19	72
2N4016	2-35	62	30	2N4354	2-20	67	72	2N5136	1-26	19	72
2N4017	2-35	62	30	2N4355	2-20	67	72	2N5137	1-27	19	72
2N4018	2-36	62	30	2N4356	2-21	67	72	2N5138	2-14	66	72
2N4019	2-36	62	30	2N4384	1-13	07	02	2N5139	2-14	66	72
2N4020	2-36	62	30	2N4386	1-13	07	02	2N5140	2-4	65	72
2N4021	2-36	62	30					2N5142	2-14	63	72

## Transistor Standard Parts List (Continued)

Device	Page	Process	Pkg.	Device	Page	Process	Pkg.	Device	Page	Process	Pkg.
2N5143	2-14	63	72	2N5817	2-15	63	77	2SC399	4-2	44	25
2N5172	1-27	04	74	2N5910	2-4	65	72	2SC454	4-2	27	74
2N5179	1-7	42	25	2N6034	2-26	3J	38	2SC458	4-2	27	74
2N5180	1-7	42	25	2N6035	2-26	3J	38	2SC460	4-2	27	74
2N5189	1-4	25	17	2N6036	2-26	3J	38	2SC461	4-2	27	74
2N5190	1-40	2E	38	2N6037	1-42	2J	38	2SC463	4-2	44	25
2N5191	1-40	2E	38	2N6038	1-42	2J	38	2SC464	4-2	42	25
2N5192	1-41	2E	38	2N6039	1-42	2J	38	2SC466	4-2	42	25
2N5193	2-26	3E	38	2N6098	1-42	4A	37	2SC495	4-2	14	38
2N5194	2-26	3E	38	2N6099	1-42	4A	37	2SC535	4-2	42	74
2N5195	2-26	3E	38	2N6100	1-42	4A	37	2SC536NP	6-4	04	74
2N5209	1-14	07	72	2N6101	1-42	4A	37	2SC562	4-3	45	28
2N5210	1-14	07	72	2N6102	1-42	4A	37	2SC563	4-3	47	28
2N5219	1-27	27	72	2N6103	1-42	4A	37	2SC644	4-3	04	74
2N5220	1-27	13	72	2N6106	2-26	5E(3E)	37	2SC682	4-3	44	25
2N5221	2-14	63	72	2N6107	2-26	5E(3E)	37	2SC683	4-3	44	25
2N5222	1-7	49	71	2N6108	2-26	5E(3E)	37	2SC684	4-3	42	74
2N5223	1-27	27	72	2N6109	2-26	5E(3E)	37	2SC717	4-3	43	74
2N5224	1-5	21	72	2N6110	2-26	5E(3E)	37	2SC733	4-3	04	74
2N5225	1-27	13	72	2N6111	2-27	5E(3E)	37	2SC735	4-3	19	74
2N5226	2-14	63	72	2N6121	1-42	4E(2E)	37	2SC761	4-3	41	25
2N5227	2-8	62	72	2N6122	1-43	4E(2E)	37	2SC762	4-3	41	25
2N5232	1-14	07	74	2N6123	1-43	4E(2E)	37	2SC784	4-3	42	74
2N5232A	1-14	07	74	2N6124	2-27	5E(3E)	37	2SC785	4-3	42	74
2N5293	1-41	4E(2E)	37	2N6125	2-27	5E(3E)	37	2SC828	4-3	04	74
2N5294	1-41	4E(2E)	37	2N6126	2-27	5E(3E)	37	2SC829	4-3	23	74
2N5295	1-41	4E(2E)	37	2N6129	1-43	4E(2E)	37	2SC947	4-3	41	25
2N5296	1-41	4E(2E)	37	2N6130	1-43	4E(2E)	37	2SC1047	4-3	42	74
2N5297	1-41	4E(2E)	37	2N6131	1-43	4E(2E)	37	2SC1117	4-3	41	25
2N5298	1-41	4E(2E)	37	2N6132	2-27	5E(3E)	37	2SC1205	4-4	27	74
2N5305	1-50	05	74	2N6133	2-27	5E(3E)	37	2SC1215	4-4	42	74
2N5306	1-50	05	74	2N6134	2-27	5E(3E)	37	2SC1306	4-4	35	37
2N5307	1-50	05	74	2N6288	1-43	4E(2E)	37	2SC1318	4-4	62	74
2N5308	1-50	05	74	2N6289	1-43	4E(2E)	37	2SC1335	4-4	04	74
2N5355	2-14	63	74	2N6290	1-43	4E(2E)	37	2SC1342	4-4	23	74
2N5365	2-14	63	74	2N6291	1-43	4E(2E)	37	2SC1344	4-4	04	74
2N5366	2-15	63	74	2N6292	1-43	4E(2E)	37	2SC1359	4-4	23	74
2N5400	2-15	74	72	2N6293	1-43	4E(2E)	37	2SC1678	4-4	35	37
2N5401	2-15	74	72	2N6386	1-43	2J	37	2SC1760	4-4	14	35
2N5490	1-41	4E(2E)	37	2N6486	1-43	4A	37	40235	1-7	42	25
2N5491	1-41	4E(2E)	37	2N6487	1-43	4A	37	40236	1-7	42	25
2N5492	1-41	4E(2E)	37	2N6488	1-43	4A	37	40237	1-7	42	25
2N5493	1-41	4E(2E)	37	2N6489	2-27	5A	37	40238	1-8	42	25
2N5494	1-41	4E(2E)	37	2N6490	2-27	5A	37	40239	1-8	42	25
2N5495	1-41	4E(2E)	37	2N6491	2-27	5A	37	40240	1-8	42	25
2N5496	1-41	4E(2E)	37	2N6554	2-21	78	35	40242	1-8	42	25
2N5497	1-41	4E(2E)	37	2N6555	2-21	78	35	40243	1-8	42	25
2N5550	1-27	16	72	2N6556	2-21	78	35	40244	1-8	42	25
2N5551	1-27	16	72	2SA719	4-2	63	74	40245	1-8	42	25
2N5655	1-42	36	38	2SA738	4-2	77	38	40246	1-8	42	25
2N5656	1-42	36	38	2SC313	4-2	42	25	40314	1-33	12	10
2N5657	1-42	36	38	2SC372	4-2	27	74	40319	2-21	67	10
2N5769	1-5	21	72	2SC380	4-2	23	74	40321	1-33	48	10
2N5770	1-7	43	72	2SC385	4-2	43	74	92PE37A	1-33	38	90
2N5771	2-4	65	72	2SC387	4-2	43	74	92PE37B	1-33	38	90
2N5772	1-5	22	72	2SC388	4-2	46	74	92PE37C	1-33	38	90
2N5816	1-27	13	77	2SC394	4-2	23	74	92PE77A	2-21	78	90
				2SC398	4-2	44	25	92PE77B	2-21	78	90

## Transistor Standard Parts List (Continued)

Device	Page	Process	Pkg.	Device	Page	Process	Pkg.	Device	Page	Process	Pkg.
92PE77C	2-21	78	90	BC169C	3-4	04	74	BC238B-92	3-9	04	77
92PE487	1-33	48	90	BC177	3-4	71	02	BC238C-92	3-9	04	77
92PE488	1-33	48	90	BC177A	3-4	71	02	BC239-92	3-9	04	77
92PE489	1-33	48	90	BC177B	3-4	71	02	BC239B-92	3-9	04	77
92PU01	1-33	37	91	BC177VI	3-4	71	02	BC239C-92	3-9	04	77
92PU01A	1-33	37	91	BC178	3-4	71	02	BC261A	3-9	71	02
92PU05	1-34	39	91	BC178A	3-4	71	02	BC261B	3-10	71	02
92PU06	1-34	39	91	BC178B	3-4	71	02	BC262A	3-10	71	02
92PU10	1-34	48	91	BC179	3-4	71	02	BC262B	3-10	71	02
92PU45	1-50	05	91	BC179A	3-4	71	02	BC263A	3-10	71	02
92PU45A	1-50	05	91	BC179B	3-5	71	02	BC263B	3-10	71	02
92PU51	2-21	77	91	BC182	3-5	04	77	BC307-92	3-10	71	77
92PU51A	2-21	77	91	BC182A	3-5	04	77	BC307A-92	3-10	71	77
92PU55	2-21	79	91	BC182B	3-5	04	77	BC307B-92	3-10	71	77
92PU56	2-21	79	91	BC182L	3-5	04	74	BC308-92	3-10	71	77
92PU57	2-22	79	91	BC182LA	3-5	04	74	BC308A-92	3-10	71	77
92PU100	1-34	39	91	BC182LB	3-5	04	74	BC308B-92	3-11	71	77
92PU200	2-22	79	91	BC183	3-5	04	77	BC308C-92	3-11	71	77
92PU391	1-34	48	91	BC183A	3-5	04	77	BC309-92	3-11	71	77
92PU392	1-34	48	91	BC183B	3-5	04	77	BC309B-92	3-11	71	77
92PU393	1-34	48	91	BC183C	3-5	04	77	BC309C-92	3-11	71	77
BC107	3-2	04	02	BC183L	3-6	04	74	BC317	3-11	04	72
BC107A	3-2	04	02	BC183LA	3-6	04	74	BC317A	3-11	04	72
BC107B	3-2	04	02	BC183LB	3-6	04	74	BC317B	3-11	04	72
BC108	3-2	04	02	BC183LC	3-6	04	74	BC318	3-11	04	72
BC108A	3-2	04	02	BC184	3-6	04	77	BC318A	3-11	04	72
BC108B	3-2	04	02	BC184B	3-6	04	77	BC318B	3-12	04	72
BC108C	3-2	04	02	BC184C	3-6	04	77	BC318C	3-12	04	72
BC109	3-2	04	02	BC184L	3-6	04	74	BC319	3-12	04	72
BC109B	3-2	04	02	BC184LB	3-6	04	74	BC319B	3-12	04	72
BC109C	3-2	04	02	BC184LC	3-6	04	74	BC319C	3-12	04	72
BC140	3-2	14	10	BC212	3-6	63	77	BC327	3-12	67	77
BC140-6	3-2	14	10	BC212A	3-6	63	77	BC327-10	3-12	67	77
BC140-10	3-2	14	10	BC212B	3-6	63	77	BC327-16	3-12	67	77
BC140-16	3-2	14	10	BC212L	3-7	63	74	BC327-25	3-12	67	77
BC141	3-2	14	10	BC212LA	3-7	63	74	BC328	3-12	67	77
BC141-6	3-2	14	10	BC212LB	3-7	63	74	BC328-10	3-12	67	77
BC141-10	3-2	14	10	BC213	3-7	63	77	BC328-16	3-12	67	77
BC143	3-2	63	03	BC213A	3-7	63	77	BC328-25	3-12	67	77
BC146-1	3-3	04	74	BC213B	3-7	63	77	BC337	3-12	14	77
BC160	3-3	67	10	BC213C	3-7	63	77	BC337-10	3-12	14	77
BC160-6	3-3	67	10	BC213L	3-7	63	74	BC337-16	3-12	14	77
BC160-10	3-3	67	10	BC213LA	3-7	63	74	BC337-25	3-12	14	77
BC160-16	3-3	67	10	BC213LB	3-7	63	74	BC338	3-13	14	77
BC161	3-3	67	10	BC213LC	3-8	63	74	BC338-10	3-13	14	77
BC161-6	3-3	67	10	BC214	3-8	63	77	BC338-16	3-13	14	77
BC161-10	3-3	67	10	BC214A	3-8	63	77	BC338-25	3-13	14	77
BC161-16	3-3	67	10	BC214B	3-8	63	77	BC485	3-13	14	77
BC167	3-3	04	74	BC214C	3-8	63	77	BC485A	3-13	14	77
BC167A	3-3	04	74	BC214L	3-8	63	74	BC485B	3-13	14	77
BC167B	3-3	04	74	BC214LB	3-8	63	74	BC485L	3-13	14	77
BC168	3-3	04	74	BC214LC	3-8	63	74	BC547	3-13	04	77
BC168A	3-3	04	74	BC237-92	3-8	04	77	BC547A	3-13	04	77
BC168B	3-3	04	74	BC237A-92	3-8	04	77	BC547B	3-13	04	77
BC168C	3-4	04	74	BC237B-92	3-8	04	77	BC547C	3-13	04	77
BC169	3-4	04	74	BC238-92	3-9	04	77	BC548	3-14	04	77
BC169B	3-4	04	74	BC238A-92	3-9	04	77	BC548A	3-14	04	77
								BC548B	3-14	04	77

## Transistor Standard Parts List (Continued)

Device	Page	Process	Pkg.	Device	Page	Process	Pkg.	Device	Page	Process	Pkg.
BC548C	3-14	04	77	BD240B	3-18	5F(3C)	37	BD373A-25	3-21	37	90
BC549	3-14	04	77	BD240C	3-18	5F(3C)	37	BD373B	3-22	38	90
BC549B	3-14	04	77	BD241	3-18	4F(2C)	37	BD373B-10	3-22	38	90
BC549C	3-14	04	77	BD241A	3-18	4F(2C)	37	BD373B-16	3-22	38	90
BC550	3-14	04	77	BD241B	3-18	4F(2C)	37	BD373B-25	3-22	38	90
BC550B	3-14	04	77	BD241C	3-18	4F(2C)	37	BD373C	3-22	38	90
BC550C	3-14	04	77	BD242	3-18	5E(3E)	37	BD373C-6	3-22	38	90
BC557	3-14	71	77	BD242A	3-18	5E(3E)	37	BD373C-10	3-22	38	90
BC557A	3-14	71	77	BD242B	3-19	5E(3E)	37	BD373C-16	3-22	38	90
BC557B	3-14	71	77	BD242C	3-19	5E(3E)	37	BD373D	3-22	39	90
BC558	3-15	71	77	BD370A	3-19	78	91	BD373D-6	3-22	39	90
BC558A	3-15	71	77	BD370A-10	3-19	78	91	BD373D-10	3-22	39	90
BC558B	3-15	71	77	BD370A-16	3-19	78	91	BD375	3-22	38	38
BC558C	3-15	71	77	BD370A-25	3-19	78	91	BD375-6	3-22	38	38
BC559	3-15	71	77	BD370B	3-19	78	91	BD375-10	3-22	38	38
BC559A	3-15	71	77	BD370B-10	3-19	78	91	BD375-16	3-22	38	38
BC559B	3-15	71	77	BD370B-16	3-19	78	91	BD375-16	3-22	38	38
BC559C	3-15	71	77	BD370B-25	3-19	78	91	BD375-25	3-22	38	38
BC560	3-15	71	77	BD370C	3-19	78	91	BD376	3-22	78	38
BC560A	3-15	71	77	BD370C-6	3-19	78	91	BD376-6	3-22	78	38
BC560B	3-15	71	77	BD370C-10	3-19	78	91	BD376-10	3-22	78	38
BC560C	3-16	71	77	BD370C-16	3-19	78	91	BD376-10	3-22	78	38
BCY56	3-16	04	02	BD370C-10	3-19	78	91	BD376-16	3-23	78	38
BCY57	3-16	04	02	BD370D	3-19	79	91	BD376-25	3-23	78	38
BCY58	3-16	04	02	BD370D-6	3-19	79	91	BD377	3-23	38	38
BCY58-7	3-16	04	02	BD370D-10	3-20	79	91	BD377-6	3-23	38	38
BCY58-8	3-16	04	02	BD371A	3-20	37	91	BD377-10	3-23	38	38
BCY58-9	3-16	04	02	BD371A-10	3-20	37	91	BD377-16	3-23	38	38
BCY58-10	3-16	04	02	BD371A-16	3-20	37	91	BD377-25	3-23	38	38
BCY59	3-16	04	02	BD371A-25	3-20	37	91	BD378	3-23	78	38
BCY59-7	3-16	04	02	BD371B	3-20	38	91	BD378-6	3-23	78	38
BCY59-8	3-16	04	02	BD371B-10	3-20	38	91	BD378-10	3-23	78	38
BCY59-9	3-16	04	02	BD371B-16	3-20	38	91	BD378-16	3-23	78	38
BCY59-10	3-16	04	02	BD371B-25	3-20	38	91	BD378-25	3-23	78	38
BCY70	3-17	71	02	BD371C	3-20	38	91	BD379	3-23	39	38
BCY71	3-17	71	02	BD371C-6	3-20	38	91	BD379-6	3-23	39	38
BCY71A	3-17	71	02	BD371C-10	3-20	38	91	BD379-10	3-23	39	38
BCY72	3-17	71	02	BD371C-16	3-20	38	91	BD379-16	3-23	39	38
BD135	3-17	37	38	BD371C-16	3-20	38	91	BD379-25	3-24	39	38
BD136	3-17	77	38	BD371D	3-20	39	91	BD380	3-24	79	38
BD137	3-17	38	38	BD371D-6	3-20	39	91	BD380-6	3-24	79	38
BD138	3-17	78	38	BD371D-10	3-20	39	91	BD380-10	3-24	79	38
BD139	3-17	39	38	BD372A	3-20	78	90	BD380-16	3-24	79	38
BD140	3-17	79	38	BD372A-10	3-20	78	90	BD380-25	3-24	79	38
BD201	3-17	4A	37	BD372A-16	3-20	78	90	BD433	3-24	2E	38
BD202	3-17	5A	37	BD372A-25	3-21	78	90	BD434	3-24	3E	38
BD233	3-17	2C	37	BD372B	3-21	78	90	BD435	3-24	2E	38
BD234	3-18	3C	38	BD372B-10	3-21	78	90	BD436	3-24	3E	38
BD235	3-18	2C	38	BD372B-16	3-21	78	90	BD437	3-24	2E	38
BD236	3-18	3C	38	BD372B-25	3-21	78	90	BD438	3-24	3E	38
BD237	3-18	2C	38	BD372C	3-21	78	90	BD439	3-24	2E	38
BD238	3-18	3C	38	BD372C-6	3-21	78	90	BD440	3-24	3E	38
BD239	3-18	4F(2C)	37	BD372C-10	3-21	78	90	BD441	3-24	2E	38
BD239A	3-18	4F(2C)	37	BD372C-16	3-21	78	90	BD442	3-25	3E	38
BD239B	3-18	4F(2C)	37	BD372D	3-21	79	90	BD533	3-25	4E(2E)	37
BD239C	3-18	4F(2C)	37	BD372D-6	3-21	79	90	BD534	3-25	5E(3E)	37
BD240	3-18	5F(3C)	37	BD372D-10	3-21	79	90	BD535	3-25	4E(2E)	37
BD240A	3-18	5F(3C)	37	BD373A	3-21	37	90	BD536	3-25	5E(3E)	37
				BD373A-10	3-21	37	90	BD537	3-25	4E(2E)	37
				BD373A-16	3-21	37	90	BD538	3-25	5E(3E)	37



## Transistor Standard Parts List (Continued)

Device	Page	Process	Pkg.	Device	Page	Process	Pkg.	Device	Page	Process	Pkg.
BD633	3-25	4F(2C)	37	BFX86	3-28	14	10	D40D10	1-34	38	35
BD634	3-25	5F(3C)	37	BFX87	3-29	63	04	D40D11	1-34	38	35
BD635	3-25	4F(2C)	37	BFX88	3-29	63	04	D40D13	1-34	38	35
BD636	3-25	5F(3C)	37	BFY72	3-29	20	04	D40D14	1-35	38	35
BD637	3-25	4F(2C)	37	BFY76	3-29	07	02	D40E1	1-35	38	35
BD638	3-25	5F(3C)	37	BSX21	3-29	07	02	D40E5	1-35	38	35
BD675	3-26	2J	38	BSX45-6	3-29	14	10	D40E7	1-35	38	35
BD675A	3-26	2J	38	BSX45-10	3-29	14	10	D40N1	1-35	48	35
BD676	3-26	3J	38	BSX45-16	3-29	14	10	D40N2	1-35	48	35
BD676A	3-26	3J	38	BSX46-6	3-29	14	10	D40N3	1-35	48	35
BD677	3-26	2J	38	BSX46-10	3-29	14	10	D40N4	1-35	48	35
BD677A	3-26	2J	38	BSX46-16	3-29	14	10	D40N5	1-35	48	35
BD678	3-26	3J	38	BSX48	3-29	20	02	D41D1	2-22	78	35
BD678A	3-26	3J	38	BSX88	3-29	21	18	D41D2	2-22	78	35
BD679	3-26	2J	38	BSY38	3-30	21	18	D41D4	2-22	78	35
BD679A	3-26	2J	38	BSY39	3-30	21	18	D41D5	2-22	78	35
BD680	3-26	3J	38	BSY51	3-30	20	04	D41D7	2-22	78	35
BD680A	3-26	3J	38	BSY52	3-30	20	04	D41D8	2-22	78	35
BD681	3-26	2J	38	BSY53	3-30	20	04	D41D10	2-22	78	35
BD682	3-26	3J	38	BSY54	3-30	20	04	D41D11	2-22	78	35
BD733	3-26	4F(2C)	37	BSY95A	3-30	21	02	D41D13	2-22	78	35
BD734	3-26	5E(3E)	37	CS9011	4-4	27	72	D41D14	2-22	78	35
BD735	3-26	4F(2C)	37	CS9012	4-4	60	72	D41E1	2-22	78	35
BD736	3-26	5E(3E)	37	CS9013	4-4	09	72	D41E5	2-22	78	35
BD737	3-26	4F(2C)	37	CS9014	4-4	04	72	D41E7	2-22	78	35
BD738	3-26	5E(3E)	37	CS9015	4-4	71	72	D42C1	1-35	37	36
BF167	3-26	45	28	CS9016	4-4	44	72	D42C2	1-35	37	36
BF180	3-26	41	25	CS9018	4-4	43	72	D42C3	1-35	37	36
BF181	3-26	41	25	DH3467CD	2-4	70	40	D42C4	1-35	37	36
BF182	3-26	41	25	DH3467CN	2-4	70	39	D42C5	1-35	37	36
BF194	3-26	46	78	DH3468CD	2-4	70	40	D42C6	1-35	37	36
BF195	3-27	46	78	DH3468CN	2-4	70	39	D42C7	1-36	38	36
BF196	3-27	45	78	DH3724CD	1-5	25	40	D42C8	1-36	38	36
BF197	3-27	47	78	DH3724CN	1-5	25	39	D42C9	1-36	38	36
BF198	3-27	45	78	DH3725CD	1-5	25	40	D42C10	1-36	38	36
BF199	3-27	47	78	DH3725CN	1-5	25	39	D42C11	1-36	38	36
BF200	3-27	41	25	D40C1	1-50	05	35	D42C12	1-36	38	36
BF233-2	3-27	49	71	D40C2	1-50	05	35	D43C1	2-22	77	36
BF233-3	3-27	49	71	D40C3	1-50	05	35	D43C2	2-22	77	36
BF233-4	3-27	49	71	D40C4	1-50	05	35	D43C3	2-22	77	36
BF233-5	3-27	49	71	D40C5	1-50	05	35	D43C4	2-22	77	36
BF240	3-27	47	78	D40C7	1-50	05	35	D43C5	2-23	77	36
BF241	3-27	47	78	D40C8	1-50	05	35	D43C6	2-23	77	36
BF254	3-27	46	78	D40D1	1-34	38	35	D43C7	2-23	78	36
BF255	3-27	46	78	D40D2	1-34	38	35	D43C8	2-23	78	36
BF257	3-27	48	10	D40D3	1-34	38	35	D43C9	2-23	78	36
BF258	3-27	48	10	D40D4	1-34	38	35	D43C10	2-23	78	36
BF259	3-28	48	10	D40D5	1-34	38	35	D43C11	2-23	78	36
BF457	3-28	48	38	D40D7	1-34	38	35	D43C12	2-23	78	36
BF458	3-28	48	38	D40D8	1-34	38	35	D44C1	1-43	4F(2C)	37
BF459	3-28	48	38					D44C2	1-43	4F(2C)	37
BFX13	3-28	66	02					D44C3	1-44	4E(2E)	37
BFX29	3-28	63	04					D44C4	1-44	4F(2C)	37
BFX30	3-28	63	04					D44C5	1-44	4F(2C)	37
BFX37	3-28	62	02					D44C6	1-44	4E(2E)	37
BFX65	3-28	62	02					D44C7	1-44	4F(2C)	37
BFX84	3-28	14	10					D44C8	1-44	4F(2C)	37
BFX85	3-28	14	10					D44C9	1-44	4E(2E)	37

## Transistor Standard Parts List (Continued)

Device	Page	Process	Pkg.	Device	Page	Process	Pkg.	Device	Page	Process	Pkg.
D44C10	1-44	4F(2C)	37	MJE712	2-29	79	38	MPS3640	2-4	65	72
D44C11	1-44	4E(2E)	37	MJE720	1-45	37	38	MPS3642	1-24	19	72
D44C12	1-44	4E(2E)	37	MJE721	1-45	38	38	MPS3644	2-15	63	72
D44H1	1-44	4A	37	MJE722	1-45	39	38	MPS3645	2-15	63	72
D44H2	1-44	4A	37	MJE800	1-45	2J	38	MPS3646	1-5	22	72
D44H4	1-44	4A	37	MJE801	1-45	2J	38	MPS3693	1-24	27	72
D44H5	1-44	4A	37	MJE802	1-45	2J	38	MPS3694	1-24	27	72
D44H7	1-44	4A	37	MJE803	1-45	2J	38	MPS3702	2-15	63	72
D44H8	1-44	4A	37	MPSA05	1-36	12	72	MPS3703	2-15	63	72
D44H10	1-44	4A	37	MPSA06	1-36	12	72	MPS3704	1-24	13	72
D44H11	1-44	4A	37	MPSA09	1-14	07	72	MPS3705	1-24	13	72
D45C1	2-27	5F(3C)	37	MPSA10	1-23	27	72	MPS3706	1-24	13	72
D45C2	2-27	5F(3C)	37	MPSA12	1-50	05	72	MPS3707	1-14	07	72
D45C3	2-27	5E(3E)	37	MPSA13	1-50	05	72	MPS3708	1-14	07	72
D45C4	2-27	5F(3C)	37	MPSA14	1-50	05	72	MPS3709	1-14	07	72
D45C5	2-27	5F(3C)	37	MPSA20	1-23	02	72	MPS3710	1-14	07	72
D45C6	2-27	5E(3E)	37	MPSA42	1-36	48	72	MPS3711	1-14	07	72
D45C7	2-27	5F(3C)	37	MPSA43	1-36	48	72	MPS3721	1-24	23	72
D45C8	2-28	5F(3C)	37	MPSA55	2-23	67	72	MPS3826	1-24	23	72
D45C9	2-28	5E(3E)	37	MPSA56	2-23	67	72	MPS3827	1-24	23	72
D45C10	2-28	5F(3C)	37	MPSA70	2-8	62	72	MPS4354	2-23	67	72
D45C11	2-28	5E(3E)	37	MPSH07	1-8	41	75	MPS4355	2-23	67	72
D45C12	2-28	5E(3E)	37	MPSH08	1-8	41	75	MPS4356	2-23	67	72
D45H1	2-28	5A	37	MPSH10	1-8	42	71	MPS5172	1-24	04	72
D45H2	2-28	5A	37	MPSH11	1-8	47	76	MPS6507	1-9	43	72
D45H4	2-28	5A	37	MPSH19	1-8	47	76	MPS6511	1-9	43	72
D45H5	2-28	5A	37	MPSH20	1-8	49	71	MPS6512	1-24	23	72
D45H7	2-28	5A	37	MPSH24	1-8	47	76	MPS6513	1-24	23	72
D45H8	2-28	5A	37	MPSH30	1-8	44	71	MPS6514	1-24	23	72
D45H10	2-28	5A	37	MPSH31	1-8	44	71	MPS6515	1-25	23	72
D45H11	2-28	5A	37	MPSH32	1-8	45	76	MPS6516	2-15	66	72
EN918	1-8	43	72	MPSH34	1-8	47	76	MPS6517	2-15	66	72
EN930	1-14	07	72	MPSH37	1-8	49	71	MPS6518	2-15	66	72
EN2222	1-23	19	72	MPSL01	1-23	16	72	MPS6520	1-25	04	72
EN2369A	1-5	21	72	MPSL51	2-15	14	72	MPS6521	1-25	04	72
EN2484	1-14	07	72	MPS706	1-5	21	72	MPS6522	2-15	66	72
EN2907	2-15	63	72	MPS834	1-5	21	72	MPS6523	2-8	62	72
MJE170	2-28	77	38	MPS2369	1-5	21	72	MPS6530	1-25	13	72
MJE171	2-28	78	38	MPS2711	1-23	23	72	MPS6531	1-25	13	72
MJE172	2-28	79	38	MPS2712	1-23	23	72	MPS6532	1-25	13	72
MJE180	1-45	37	38	MPS2713	1-5	21	72	MPS6533	2-16	63	72
MJE181	1-45	38	38	MPS2714	1-5	21	72	MPS6534	2-16	63	72
MJE182	1-45	39	38	MPS2716	1-23	23	72	MPS6535	2-16	63	72
MJE340	1-45	36	38	MPS2923	1-23	04	72	MPS6539	1-9	42	71
MJE341	1-45	36	38	MPS2924	1-23	04	72	MPS6540	1-9	49	71
MJE3439	1-45	36	38	MPS2925	1-23	04	72	MPS6541	1-9	43	72
MJE344	1-45	36	38	MPS2926	1-23	04	72	MPS6542	1-9	47	76
MJE3440	1-45	36	38	MPS3392	1-23	04	72	MPS6543	1-9	47	76
MJE370	2-28	3C	38	MPS3393	1-24	04	72	MPS6544	1-9	49	71
MJE371	2-28	3E	38	MPS3394	1-24	04	72	MPS6546	1-9	47	76
MJE520	1-45	2C	38	MPS3395	1-24	04	72	MPS6547	1-9	47	76
MJE521	1-45	2C	38	MPS3396	1-24	04	72	MPS6548	1-9	42	71
MJE700	2-28	3J	38	MPS3397	1-24	04	72	MPS6560	1-36	14	72
MJE701	2-29	3J	38	MPS3398	1-24	04	72	MPS6561	1-36	14	72
MJE702	2-29	3J	38	MPS3563	1-9	43	72	MPS6562	2-23	67	72
MJE703	2-29	3J	38	MPS3638	2-15	63	72	MPS6563	2-23	60	72
MJE710	2-29	77	38	MPS3638A	2-15	63	72	MPS6564	1-25	27	72
MJE711	2-29	78	38	MPS3639	2-4	65	72	MPS6565	1-25	27	72

# Transistor Standard Parts List (Continued)

Transistor Standard Parts List

Device	Page	Process	Pkg.	Device	Page	Process	Pkg.	Device	Page	Process	Pkg.
MPS6566	1-25	27	72	NB012E	5-36	04	72	NB221Y	5-48	63	90
MPS6567	1-9	49	71	NB012F	5-36	04	74	NB222E	5-48	63	72
MPS6568A	1-9	44	71	NB012H	5-36	04	77	NB222F	5-48	63	74
MPS6569	1-9	44	71	NB013E	5-40	04	72	NB222H	5-48	63	77
MPS6570	1-9	44	71	NB013F	5-40	04	74	NB222X	5-48	63	91
MPS6571	1-14	07	72	NB013H	5-40	04	77	NB222Y	5-48	63	90
MPS6573	1-25	02	72	NB014E	5-40	04	72	NB223E	5-48	63	72
MPS6574	1-25	02	72	NB014F	5-40	04	74	NB223F	5-48	63	74
MPS6575	1-25	02	72	NB014H	5-40	04	77	NB223H	5-48	63	77
MPS6576	1-25	02	72	NB021E	5-36	62	72	NB223X	5-48	63	91
MRF472	1-45	35	38	NB021F	5-36	62	74	NB223Y	5-48	63	90
MRF501	1-9	42	25	NB021H	5-36	62	77	NB311E	5-52	38	72
MRF502	1-9	42	25	NB022E	5-36	62	72	NB311F	5-52	38	74
MRF8004	1-36	35	10	NB022F	5-36	62	74	NB311H	5-52	38	77
NA01E	5-4	09	72	NB022H	5-36	62	77	NB311K	5-52	38	35
NA01F	5-4	09	74	NB023E	5-40	62	72	NB311M	5-52	38	36
NA01H	5-4	09	77	NB023F	5-40	62	74	NB311X	5-52	38	91
NA02E	5-4	60	72	NB023H	5-40	62	77	NB311Y	5-52	38	90
NA02F	5-4	60	74	NB024E	5-40	62	72	NB321E	5-52	38	72
NA02H	5-4	60	77	NB024F	5-40	62	74	NB312F	5-52	38	74
NA11E	5-8	09	72	NB024H	5-40	62	77	NB312H	5-52	38	77
NA11F	5-8	09	74	NB111E	5-44	04	72	NB312K	5-52	38	35
NA11H	5-8	09	77	NB111F	5-44	04	74	NB312M	5-52	38	36
NA12E	5-8	60	72	NB111H	5-44	04	77	NB312X	5-52	38	91
NA12F	5-8	60	74	NB112E	5-44	04	72	NB312Y	5-52	38	90
NA12H	5-8	60	77	NB112F	5-44	04	74	NB313E	5-52	38	72
NA22E	5-12	77	72	NB112H	5-44	04	77	NB313F	5-52	38	74
NA22F	5-12	77	74	NB113E	5-44	04	72	NB313H	5-52	38	77
NA22H	5-12	77	77	NB113F	5-44	04	74	NB313K	5-52	38	35
NA22X	5-12	77	91	NB113H	5-44	04	77	NB313M	5-52	38	36
NA22Y	5-12	77	90	NB121E	5-44	62	72	NB313X	5-52	38	91
NA31K	5-16	37	35	NB121F	5-44	62	74	NB313Y	5-52	38	90
NA31M	5-16	37	36	NB121H	5-44	62	77	NB321E	5-52	78	72
NA31X	5-16	37	91	NB122E	5-44	62	72	NB321F	5-52	78	74
NA31Y	5-16	37	90	NB122F	5-44	62	74	NB321H	5-52	78	77
NA32K	5-16	77	35	NB122H	5-44	62	77	NB321K	5-52	78	35
NA32M	5-16	77	36	NB123E	5-44	62	72	NB321M	5-52	78	36
NA32X	5-16	77	91	NB123F	5-44	62	74	NB321X	5-52	78	91
NA32Y	5-16	77	90	NB123H	5-44	62	77	NB321Y	5-52	78	90
NA41U	5-20	37	38	NB211E	5-48	19	72	NB322E	5-52	78	72
NA41W	5-20	37	37	NB211F	5-48	19	74	NB322F	5-52	78	74
NA42U	5-20	77	38	NB211H	5-48	19	77	NB322H	5-52	78	77
NA42W	5-20	77	37	NB211X	5-48	19	91	NB322K	5-52	78	35
NA51U	5-24	2C	38	NB211Y	5-48	19	90	NB322M	5-52	78	36
NA51W	5-24	4F(2C)	37	NB212E	5-48	19	72	NB322X	5-52	78	91
NA52U	5-24	3C	38	NB212F	5-48	19	74	NB322Y	5-52	78	90
NA52W	5-24	5F(3C)	37	NB212H	5-48	19	77	NB323E	5-52	78	72
NA61U	5-28	2E	38	NB212X	5-48	19	91	NB323F	5-52	78	74
NA61W	5-28	4E(2E)	37	NB212Y	5-48	19	90	NB323H	5-52	78	77
NA62U	5-28	3E	38	NB213E	5-48	19	72	NB323K	5-52	78	35
NA62W	5-28	5E(3E)	37	NB213F	5-48	19	74	NB323M	5-52	78	36
NA71U	5-32	2E	38	NB213H	5-48	19	77	NB323X	5-52	78	91
NA71W	5-32	4E(2E)	37	NB213X	5-48	19	91	NB323Y	5-52	78	90
NA72U	5-32	3E	38	NB213Y	5-48	19	90	NCBJ14	1-45	14	38
NA72W	5-32	5E(3E)	37	NB221E	5-48	63	72	NCBJ35	1-45	35	38
NB011E	5-36	04	72	NB221F	5-48	63	74	NCBS14	1-36	14	10
NB011F	5-36	04	74	NB221H	5-48	63	77	NCBS35	1-36	35	10
NB011H	5-36	04	77	NB221X	5-48	63	91	NCBT13	1-25	13	72

## Transistor Standard Parts List (Continued)

Device	Page	Process	Pkg.	Device	Page	Process	Pkg.	Device	Page	Process	Pkg.
NCBV 14	1-36	14	35	NSDU51	2-24	77	35	NSP698A	2-30	5J(3J)	37
NCBW35	1-45	35	37	NSDU51A	2-24	77	35	NSP699	1-46	4J(2J)	37
NCBX 14	1-36	14	91	NSDU52	2-24	77	35	NSP699A	1-46	4J(2J)	37
NR041E	5-68	04	72	NSDU55	2-24	78	35	NSP700	2-30	5J(3J)	37
NR041F	5-68	04	74	NSDU56	2-24	79	35	NSP700A	2-30	5J(3J)	37
NR041H	5-68	04	77	NSDU57	2-24	79	35	NSP701	1-46	4J(2J)	37
NR421D	5-56	42	71	NSE170	2-24	77	36	NSP702	2-30	5J(3J)	37
NR421F	5-56	42	74	NSE171	2-25	78	36	NSP2010	2-30	5A	37
NR431E	5-60	43	72	NSE180	1-38	37	36	NSP2011	2-30	5A	37
NR431F	5-60	43	74	NSE181	1-38	38	36	NSP2020	1-47	4A	37
NR431H	5-60	43	77	NSE457	1-39	48	36	NSP2021	1-47	4A	37
NR461E	5-64	46	72	NSE458	1-39	48	36	NSP2090	2-30	5J(3J)	37
NR461F	5-64	46	74	NSE459	1-39	48	36	NSP2091	2-30	5J(3J)	37
NR461H	5-64	46	77	NSP41	1-46	4E(2E)	37	NSP2092	2-30	5J(3J)	37
NS3762	2-5	70	17	NSP41A	1-46	4E(2E)	37	NSP2093	2-30	5J(3J)	37
NS3763	2-5	70	17	NSP41B	1-46	4E(2E)	37	NSP2100	1-47	4J(2J)	37
NS3903	1-25	23	02	NSP41C	1-46	4E(2E)	37	NSP2101	1-47	4J(2J)	37
NS3904	1-26	23	02	NSP42	2-29	5E(3E)	37	NSP2102	1-47	4J(2J)	37
NS3905	2-16	66	02	NSP42A	2-29	5E(3E)	37	NSP2103	1-47	4J(2J)	37
NS3906	2-16	66	02	NSP42B	2-29	5E(3E)	37	NSP2370	2-30	5F(3C)	37
NSC460	1-9	46	74	NSP42C	2-29	5E(3E)	37	NSP2480	1-47	4A	37
NSC461	1-9	46	74	NSP105	2-29	5A	37	NSP2481	1-47	4A	37
NSD102	1-36	37	35	NSP205	1-46	4A	37	NSP2482	1-47	4A	37
NSD103	1-37	37	35	NSP370	2-29	5F(3C)	37	NSP2483	1-47	4A	37
NSD104	1-37	39	35	NSP371	2-29	5F(3C)	37	NSP2490	2-30	5E(3E)	37
NSD105	1-37	39	35	NSP520	1-46	4F(2C)	37	NSP2491	2-30	5E(3E)	37
NSD106	1-37	39	35	NSP521	1-46	4F(2C)	37	NSP2520	1-47	4F(2C)	37
NSD123	1-37	08	35	NSP575	1-46	4F(2C)	37	NSP2955	2-30	5A	37
NSD131	1-37	48	35	NSP576	2-29	5F(3C)	37	NSP3054	1-47	4E(2E)	37
NSD132	1-37	48	35	NSP577	1-46	4F(2C)	37	NSP3055	1-47	4A	37
NSD133	1-37	48	35	NSP578	2-29	5F(3C)	37	NSP3740	2-30	5F(3C)	37
NSD134	1-37	48	35	NSP579	1-46	4F(2C)	37	NSP3741	2-30	5F(3C)	37
NSD135	1-37	48	35	NSP580	2-29	5F(3C)	37	NSP4918	2-31	5F(3C)	37
NSD202	2-23	77	35	NSP581	1-46	4F(2C)	37	NSP4919	2-31	5F(3C)	37
NSD203	2-24	77	35	NSP582	2-29	5F(3C)	37	NSP4920	2-31	5F(3C)	37
NSD204	2-24	79	35	NSP585	1-46	4E(2E)	37	NSP4921	1-47	4F(2C)	37
NSD205	2-24	79	35	NSP586	2-29	5E(3E)	37	NSP4922	1-47	4F(2C)	37
NSD206	2-24	79	35	NSP587	1-46	4E(2E)	37	NSP4923	1-47	4F(2C)	37
NSD457	1-37	48	35	NSP588	2-29	5E(3E)	37	NSP5190	1-47	4E(2E)	37
NSD458	1-38	48	35	NSP589	1-46	4E(2E)	37	NSP5191	1-47	4E(2E)	37
NSD459	1-37	48	35	NSP590	2-29	5E(3E)	37	NSP5192	1-48	4E(2E)	37
NSD3439	1-38	36	35	NSP595	1-46	4E(2E)	37	NSP5193	2-31	5E(3E)	37
NSD3440	1-38	36	35	NSP596	2-29	5E(3E)	37	NSP5194	2-31	5E(3E)	37
NSD6178	1-38	38	35	NSP597	1-46	4E(2E)	37	NSP5195	2-31	5E(3E)	37
NSD6179	1-38	38	35	NSP598	2-29	5E(3E)	37	NSP5974	2-31	5A	37
NSD6180	2-24	78	35	NSP599	1-46	4E(2E)	37	NSP5975	2-31	5A	37
NSD6181	2-24	78	35	NSP600	2-30	5E(3E)	37	NSP5976	2-31	5A	37
NSDU01	1-38	37	35	NSP601	1-46	4A	37	NSP5977	1-48	4A	37
NSDU01A	1-38	37	35	NSP602	2-30	5A	37	NSP5978	1-48	4A	37
NSDU02	1-38	37	35	NSP695	1-46	4J(2J)	37	NSP5979	1-48	4A	37
NSDU05	1-38	38	35	NSP695A	1-46	4J(2J)	37	NSP5980	2-31	5A	37
NSDU06	1-38	39	35	NSP696A	2-30	5J(3J)	37	NSP5981	2-31	5A	37
NSDU07	1-38	39	35	NSP697	1-46	4J(2J)	37	NSP5982	2-31	5A	37
NSDU10	1-38	48	35	NSP697A	1-46	4J(2J)	37	NSP5983	1-48	4A	37
				NSP698	2-30	5J(3J)	37	NSP5984	1-48	4A	37
								NSP5985	1-48	4A	37
								PE3100	1-10	47	76
								PE4010	1-14	07	72

# Transistor Standard Parts List (Continued)

Transistor Standard Parts List

Device	Page	Process	Pkg.	Device	Page	Process	Pkg.	Device	Page	Process	Pkg.
PE5025	1-10	46	72	PN5129	1-23	19	72	TIP62B	2-32	5F(3C)	37
PE5029	1-10	47	76	PN5130	1-10	43	72	TIP62C	2-32	5F(3C)	37
PE5030B	1-10	47	76	PN5131	1-23	27	72	TIP110	1-49	4J(2J)	37
PE5031	1-10	47	76	PN5132	1-23	27	72	TIP111	1-49	4J(2J)	37
PN918	1-10	43	72	PN5133	1-14	07	72	TIP112	1-49	4J(2J)	37
PN930	1-14	07	72	PN5134	1-6	21	72	TIP115	2-32	5J(3J)	37
PN2221	1-21	19	72	PN5135	1-23	19	72	TIP116	2-32	5J(3J)	37
PN2221A	1-21	19	72	PN5136	1-23	19	72	TIP117	2-32	5J(3J)	37
PN2222	1-22	19	72	PN5137	1-23	19	72	TIP120	1-49	4K	37
PN2222A	1-22	19	72	PN5138	2-18	66	72	TIP121	1-49	4K	37
PN2369	1-5	21	72	PN5139	2-18	66	72	TIP122	1-49	4K	37
PN2369A	1-6	21	72	PN5140	2-5	65	72	TIP125	2-32	5K	37
PN2484	1-14	07	72	PN5142	2-18	63	72	TIP126	2-32	5K	37
PN2906	2-16	63	72	PN5143	2-18	63	72	TIP127	2-32	5K	37
PN2906A	2-16	63	72	PN5179	1-10	42	71	TIP130	1-49	4K	37
PN2907	2-16	63	72	PN5910	2-5	65	72	TIP131	1-49	4K	37
PN2907A	2-16	63	72	PN7055	1-39	48	72	TIP132	1-49	4K	37
PN3563	1-10	43	72	SE5020	1-10	44	25	TIP135	2-33	5K	37
PN3564	1-10	43	72	SE5021	1-10	44	25	TIP136	2-33	5K	37
PN3565	1-14	07	72	SE5022	1-10	44	25	TIP137	2-33	5K	37
PN3566	1-39	14	72	SE5023	1-10	44	25	TIS86	1-10	47	78
PN3567	1-39	14	72	SE5024	1-10	44	25	TIS87	1-10	47	78
PN3568	1-39	12	72	SE5050	1-10	44	25	TN2102	1-39	12	91
PN3569	1-39	14	72	SE5051	1-10	44	25	TN2219	1-27	19	91
PN3638	2-16	63	72	SE5052	1-10	44	25	TN2219A	1-27	9	91
PN3638A	2-17	63	72	SE5055	1-10	45	28	TN2905	2-18		91
PN3639	2-5	65	72	SE7055	1-39	48	10	TN2905A	2-18		91
PN3640	2-5	65	72	SE7056	1-39	48	10	TN3019	1-40	12	91
PN3641	1-22	19	72	SV7056	1-39	48	35	TN3020	1-40	12	91
PN3642	1-22	19	72	TIP29	1-48	4F(2C)	37	TN3053	1-40	12	
PN3643	1-22	19	72	TIP29A	1-48	4F(2C)	37	TN4036	2-25	67	
PN3644	2-17	63	72	TIP29B	1-48	4F(2C)	37	TN4037	2-25	67	91
PN3645	2-17	63	72	TIP29C	1-48	4F(2C)	37				
PN3646	1-6	22	72	TIP30	2-31	5F(3C)	37				
PN3691	1-22	23	72	TIP30A	2-31	5F(3C)	37				
PN3692	1-22	23	72	TIP30C	2-32	5F(3C)	37				
PN3694	1-22	27	72	TIP31	1-48	4F(2C)	37				
PN4121	2-17	66	72	TIP31A	1-48	4F(2C)	37				
PN4122	2-17	66	72	TIP31B	1-48	4F(2C)	37				
PN4140	1-22	19	72	TIP31C	1-48	4F(2C)	37				
PN4141	1-22	19	72	TIP32	2-32	5F(3C)	37				
PN4142	2-17	63	72	TIP32A	2-32	5F(3C)	37				
PN4143	2-17	63	72	TIP32B	2-32	5F(3C)	37				
PN4248	2-8	62	72	TIP32C	2-32	5F(3C)	37				
PN4249	2-8	62	72	TIP41	1-48	4A	37				
PN4250	2-8	62	72	TIP41A	1-49	4A	37				
PN4250A	2-8	62	72	TIP41B	1-49	4A	37				
PN4258	2-5	65	72	TIP41C	1-49	4A	37				
PN4258A	2-5	65	72	TIP42	2-32	5A	37				
PN4274	1-6	21	72	TIP42A	2-32	5A	37				
PN4275	1-6	21	72	TIP42B	2-32	5A	37				
PN4354	2-25	67	72	TIP42C	2-32	5A	37				
PN4355	2-25	67	72	TIP61	1-49	4F(2C)	37				
PN4356	2-25	67	72	TIP61A	1-49	4F(2C)	37				
PN4916	2-18	66	72	TIP61B	1-49	4F(2C)	37				
PN4917	2-18	66	72	TIP61C	1-49	4F(2C)	37				
PN5127	1-22	27	72	TIP62	2-32	5F(3C)	37				
PN5128	1-22	19	72	TIP62A	2-32	5F(3C)	37				

## FET Parts List

Device	Process/ Package	Selection Guide	Process Page	Device	Process/ Package	Selection Guide	Process Page
• 2N2608	89/11	8-12	9-22	2N4118A	53/25	8-6	9-9
2N2609	88/11	8-12	9-20	2N4119	53/25	8-6	9-9
2N3069	52/02	8-6	9-7	2N4119A	53/25	8-6	9-9
2N3070	52/02	8-6	9-7	2N4220	55/25	8-7	9-11
2N3329	89/23	8-12	9-22	2N4220A	55/25	8-7	9-11
2N3330	89/23	8-12	9-22	2N4221	55/25	8-7	9-11
2N3331	89/23	8-12	9-22	2N4221A	55/25	8-7	9-11
2N3332	89/23	8-12	9-22	2N4222	55/25	8-7	9-11
2N3368	52/02	8-6	9-7	2N4222A	55/25	8-7	9-11
2N3369	52/02	8-6	9-7	2N4223	50/25	8-4	9-2
2N3370	52/02	8-6	9-7	2N4224	50/25	8-4	9-2
2N3382	88/23	8-12	9-20	2N4338	52/02	8-7	9-7
2N3384	88/23	8-12	9-20	2N4339	52/02	8-7	9-7
2N3386	88/23	8-12	9-20	2N4340	52/02	8-7	9-7
2N3436	55/02	8-6	9-11	2N4341	52/02	8-7	9-7
2N3437	55/02	8-6	9-11	2N4381	89/11	8-12	9-22
2N3438	55/02	8-6	9-11	2N4391	51/02	8-2	9-5
2N3458	52/02	8-6	9-7	2N4392	51/02	8-2	9-5
2N3459	52/02	8-6	9-7	2N4393	51/02	8-2	9-5
2N3460	52/02	8-6	9-7	2N4416	50/25	8-4	9-2
2N3684	52/25	8-6	9-7	• 2N4416A	50/25	8-4	9-2
2N3685	52/25	8-6	9-7	• 2N4856	51/02	8-2	9-5
2N3686	52/25	8-6	9-7	2N4856A	51/02	8-2	9-5
2N3687	52/25	8-6	9-7	• 2N4857	51/02	8-2	9-5
2N3819	50/74	8-4	9-2	2N4857A	51/02	8-2	9-5
2N3821	55/25	8-6	9-11	• 2N4858	51/02	8-2	9-5
2N3822	55/25	8-6	9-11	2N4858A	51/02	8-2	9-5
• 2N3823	50/25	8-4	9-2	• 2N4859	51/02	8-2	9-5
2N3824	55/25	8-2	9-11	2N4859A	51/02	8-2	9-5
2N3921	83/12	8-8	9-15	• 2N4860	51/02	8-2	9-5
2N3922	83/12	8-8	9-15	2N4860A	51/02	8-2	9-5
2N3954	83/12	8-8	9-15	• 2N4861	51/02	8-2	9-5
2N3954A	83/12	8-8	9-15	2N4861A	51/02	8-2	9-5
2N3955	83/12	8-8	9-15	2N5018	88/11	8-12	9-20
2N3955A	83/12	8-8	9-15	2N5019	88/11	8-12	9-20
2N3956	83/12	8-8	9-15	2N5020	89/11	8-13	9-22
2N3957	83/12	8-8	9-15	2N5021	89/11	8-13	9-22
2N3958	83/12	8-8	9-15	2N5045	83/12	8-9	9-15
2N3966	50/25	8-2	9-2	2N5046	83/12	8-9	9-15
2N3967	52/25	8-6	9-7	2N5047	83/12	8-9	9-15
2N3967A	52/25	8-6	9-7	2N5078	50/25	8-4	9-2
2N3968	52/25	8-6	9-7	2N5103	50/25	8-7	9-2
2N3968A	52/25	8-6	9-7	2N5104	50/25	8-7	9-2
2N3969	52/25	8-6	9-7	2N5105	50/25	8-7	9-2
2N3969A	52/25	8-6	9-7	• 2N5114	88/11	8-12	9-20
2N3970	51/02	8-2	9-5	• 2N5115	88/11	8-12	9-20
2N3971	51/02	8-2	9-5	• 2N5116	88/11	8-12	9-20
2N3972	51/02	8-2	9-5	2N5196	83/12	8-9	9-15
2N3993	88/23	8-12	9-20	2N5197	83/12	8-9	9-15
2N3993A	88/23	8-12	9-20	2N5198	83/12	8-9	9-15
2N3994	88/23	8-12	9-20	2N5199	83/12	8-9	9-15
2N3994A	88/23	8-12	9-20	2N5245	90/77	8-4	9-24
2N4084	83/12	8-8	9-15	2N5246	90/77	8-4	9-24
2N4085	83/12	8-8	9-15	2N5247	90/77	8-4	9-24
• 2N4091	51/02	8-2	9-5	2N5248	50/74	8-4	9-2
• 2N4092	51/02	8-2	9-5	2N5358	55/25	8-7	9-11
• 2N4093	51/02	8-2	9-5	2N5359	55/25	8-7	9-11
2N4117	53/25	8-6	9-9	2N5360	55/25	8-7	9-11
2N4117A	53/25	8-6	9-9	2N5361	55/25	8-7	9-11
2N4118	53/25	8-6	9-9				

• Denotes JAN qualified type

# FET Parts List (Continued)

Device	Process/ Package	Selection Guide	Process Page	Device	Process/ Package	Selection Guide	Process Page
2N5362	55/25	8-7	9-11	2N5912	93/24	8-10	9-28
2N5363	55/25	8-7	9-11	2N5949	50/77	8-4	9-2
2N5364	55/25	8-7	9-11	2N5950	50/77	8-4	9-2
2N5397	90/29	8-4	9-24	2N5951	50/77	8-4	9-2
2N5398	90/29	8-4	9-24	2N5952	50/77	8-4	9-2
2N5432	58/07	8-2	9-13	2N5953	50/77	8-4	9-2
2N5433	58/07	8-2	9-13	2N6483	95/12	8-10	9-32
2N5434	58/07	8-2	9-13	2N6484	95/12	8-10	9-32
2N5452	83/12	8-9	9-15	2N6485	95/12	8-10	9-32
2N5453	83/12	8-9	9-15	BC264A	50/77	8-13	9-2
2N5454	83/12	8-9	9-15	BC264B	50/77	8-13	9-2
2N5457	55/72	8-7	9-11	BC264C	50/77	8-13	9-2
2N5458	55/72	8-7	9-11	BC264D	50/77	8-13	9-2
2N5459	55/72	8-7	9-11	BF244A	50/74	8-13	9-2
2N5460	89/71	8-13	9-22	BF244B	50/74	8-13	9-2
2N5461	89/71	8-13	9-22	BF244C	50/74	8-13	9-2
2N5462	89/71	8-13	9-22	BF245A	50/77	8-13	9-2
2N5484	50/72	8-4	9-2	BF245B	50/77	8-13	9-2
2N5485	50/72	8-4	9-2	BF245C	50/77	8-13	9-2
2N5486	50/72	8-4	9-2	BF246A	51/74	8-13	9-5
2N5515	95/12	8-10	9-32	BF246B	51/74	8-13	9-5
2N5516	95/12	8-10	9-32	BF246C	51/74	8-13	9-5
2N5517	95/12	8-10	9-32	BF247A	51/77	8-13	9-5
2N5518	95/12	8-10	9-32	BF247B	51/77	8-13	9-5
2N5519	95/12	8-10	9-32	BF247C	51/77	8-13	9-5
2N5520	95/12	8-10	9-32	BF256A	50/77	8-13	9-2
2N5521	95/12	8-10	9-32	BF256B	50/77	8-13	9-2
2N5522	95/12	8-10	9-32	BF256C	50/77	8-13	9-2
2N5523	95/12	8-10	9-32	J108	58/72	8-3	9-13
2N5524	95/12	8-10	9-32	J109	58/72	8-3	9-13
2N5545	*83/12	8-9	9-15	J110	58/72	8-3	9-13
2N5546	*83/12	8-9	9-15	J111	51/72	8-3	9-5
2N5547	*83/12	8-9	9-15	J112	51/72	8-3	9-5
2N5555	50/72	8-2	9-2	J113	51/72	8-3	9-5
2N5556	50/25	8-7	9-2	J114	90/72	8-3	9-24
2N5557	50/25	8-7	9-2	J174	88/74	8-12	9-20
2N5558	50/25	8-7	9-2	J175	88/74	8-12	9-20
2N5561	†98/12	8-9	9-36	J176	88/74	8-12	9-20
2N5562	†98/12	8-9	9-36	J177	88/74	8-12	9-20
2N5563	†98/12	8-9	9-36	J201	52/72	8-7	9-7
2N5564	96/12	8-10	9-34	J202	52/72	8-7	9-7
2N5565	96/12	8-10	9-34	J203	52/72	8-7	9-7
2N5566	96/12	8-10	9-34	J210	90/72	8-7	9-24
2N5638	51/72	8-3	9-5	J211	90/72	8-7	9-24
2N5639	51/72	8-3	9-5	J212	90/72	8-7	9-24
2N5640	51/72	8-3	9-5	J270	88/74	8-13	9-20
2N5653	51/72	8-3	9-5	J271	88/74	8-13	9-20
2N5654	51/72	8-3	9-5	J300	90/72	8-4	9-24
2N5668	50/72	8-4	9-2	J304	50/72	8-4	9-2
2N5659	50/72	8-4	9-2	J305	50/72	8-4	9-2
2N5670	50/72	8-4	9-2	J308	92/72	8-4	9-26
2N5902	84/24	8-11	9-17	J309	92/72	8-4	9-26
2N5903	84/24	8-11	9-17	J310	92/72	8-4	9-26
2N5904	84/24	8-11	9-17	J401	†98/60	8-9	9-36
2N5905	84/24	8-11	9-17	J402	†98/60	8-9	9-36
2N5906	84/24	8-11	9-17	J403	†98/60	8-9	9-36
2N5907	84/24	8-11	9-17	J404	†98/60	8-9	9-36
2N5908	84/24	8-11	9-17	J405	†98/60	8-9	9-36
2N5909	84/24	8-11	9-17	J406	†98/60	8-9	9-36
2N5911	93/24	8-10	9-28	J410	83/60	8-9	9-15

\*JAN qualification pending. Consult factory.  
†Process in development

# FET Parts List (Continued)

Device	Process/ Package	Selection Guide	Process Page	Device	Process/ Package	Selection Guide	Process Page
J411	83/60	8-9	9-15	PN4856	51/72	8-3	9-5
J412	83/60	8-9	9-15	PN4857	51/72	8-3	9-5
MPF102	50/72	8-5	9-2	PN4858	51/72	8-3	9-5
MPF103	55/72	8-7	9-11	PN4859	51/72	8-3	9-5
MPF104	55/72	8-7	9-11	PN4860	51/72	8-3	9-5
MPF105	55/72	8-7	9-11	PN4861	51/72	8-3	9-5
MPF106	50/72	8-5	9-2	PN5033	89/71	8-13	9-22
MPF107	50/72	8-5	9-2	PN5163	50/72	8-8	9-2
MPF108	55/72	8-5	9-11	TIS58	50/74	8-8	9-2
MPF109	55/72	8-7	9-11	TIS59	50/74	8-8	9-2
MPF111	50/72	8-8	9-2	TIS73	51/77	8-3	9-5
MPF112	55/72	8-8	9-11	TIS74	51/77	8-3	9-5
NDF9401	94/24	8-11	9-30	TIS75	51/77	8-3	9-5
NDF9402	94/24	8-11	9-30	U1897E	51/72	8-3	9-5
NDF9403	94/24	8-11	9-30	U1898E	51/72	8-3	9-5
NDF9404	94/24	8-11	9-30	U1899E	51/72	8-3	9-5
NDF9405	94/24	8-11	9-30	U231	83/12	8-9	9-15
NDF9406	94/12	8-11	9-30	U232	83/12	8-9	9-15
NDF9407	94/12	8-11	9-30	U233	83/12	8-9	9-15
NDF9408	94/12	8-11	9-30	U234	83/12	8-9	9-15
NDF9409	94/12	8-11	9-30	U235	83/12	8-9	9-15
NDF9410	94/12	8-11	9-30	U257	93/24	8-10	9-28
NF5101	51/25	8-5	9-5	U301	88/11	8-13	9-20
NF5102	51/25	8-5	9-5	U304	88/11	8-12	9-20
NF5103	51/25	8-5	9-5	U305	88/11	8-12	9-20
NPD5564	96/67	8-10	9-34	U306	88/11	8-12	9-20
NPD5565	96/67	8-10	9-34	U308	92/07	8-5	9-26
NPD5566	96/67	8-10	9-34	U309	92/07	8-5	9-26
NPD8301	83/67	8-9	9-15	U310	92/07	8-5	9-26
NPD8302	83/67	8-9	9-15	U312	90/07	8-5	9-24
NPD8303	83/67	8-9	9-15	U320	58/09	8-5	9-13
NPD9801	†98/67	8-9		U321	58/09	8-5	9-13
NPD9802	†98/67	8-9		U322	58/09	8-5	9-13
NPD9803	†98/67	8-9		U401	†98/12	8-9	9-36
P1086E	88/71	8-12	9-20	U402	†98/12	8-9	9-36
P1087E	88/71	8-12	9-20	U403	†98/12	8-9	9-36
PF5101	51/72	8-5	9-5	U404	†98/12	8-9	9-36
PF5102	51/72	8-5	9-5	U405	†98/12	8-9	9-36
PF5103	51/72	8-5	9-5	U406	†98/12	8-9	9-36
PN3684	52/72	8-8	9-7	U421	†86/24	8-11	9-19
PN3685	52/72	8-8	9-7	U422	†86/24	8-11	9-19
PN3686	52/72	8-8	9-7	U423	†86/24	8-11	9-19
PN3687	52/72	8-8	9-7	U424	†86/24	8-11	9-19
PN4091	51/72	8-3	9-5	U425	†86/24	8-11	9-19
PN4092	51/72	8-3	9-5	U426	†86/24	8-11	9-19
PN4093	51/72	8-3	9-5	U430	92/24	8-10	9-26
PN4220	55/72	8-8	9-11	U431	92/24	8-10	9-26
PN4221	55/72	8-8	9-11				
PN4222	55/72	8-8	9-11				
PN4223	50/72	8-5	9-2				
PN4224	50/72	8-5	9-2				
PN4302	52/72	8-8	9-7				
PN4303	52/72	8-8	9-7				
PN4304	52/72	8-8	9-7				
PN4342	89/71	8-13	9-22				
PN4360	89/71	8-13	9-22				
PN4391	51/72	8-3	9-5				
PN4392	51/72	8-3	9-5				
PN4393	51/72	8-3	9-5				
PN4416	50/72	8-5	9-2				

†Process in development



# MIL-STD Qualifications

## MIL-STD-19500 Qualifications

TYPE	DETAIL SPEC.	QUALIFICATION			TYPE	DETAIL SPEC.	QUALIFICATION		
		JAN	JTX	JTXV			JAN	JTX	JTXV
2N918	301	X	X	X	2N2920	355	X	X	X
2N929	253	X	X		2N3019	391	X	X	X
2N930	253	X	X		2N3250A	323	X	X	X
2N2218	251	X	X	X	2N3251A	323	X	X	X
2N2218A	251	X	X	X	2N3498	366	X	X	X
2N2219	251	X	X	X	2N3499	366	X	X	X
2N2219A	251	X	X	X	2N3500	366	X	X	X
2N2221	255	X	X	X	2N3501	366	X	X	X
2N2221A	255	X	X	X	2N3700	391	X	X	X
2N2222	255	X	X	X	2N3810	366	X	X	X
2N2222A	255	X	X	X	2N3811	366	X	X	X
2N2369A	317	X	X	X	2N3823	375	X	X	X
2N2484	376	X	X	X	2N4091	431	X	X	
2N2604	354	X	X	X	2N4092	431	X	X	
2N2605	354	X	X	X	2N4093	431	X	X	
2N2608	295	X	X	X	2N4856	385	X	X	X
2N2857	343	X	X	X	2N4857	385	X	X	X
2N2904	290	X	X	X	2N4858	385	X	X	X
2N2904A	290	X	X	X	2N4859	385	X	X	X
2N2905	290	X	X	X	2N4860	385	X	X	X
2N2905A	290	X	X	X	2N4861	385	X	X	X
2N2906	291	X	X	X	2N5114	476	X	X	X
2N2906A	291	X	X	X	2N5115	476	X	X	X
2N2907	291	X	X	X	2N5116	476	X	X	X
2N2907A	291	X	X	X					

### JANTX, TXV, NX and NXV Processing

The 100% reliability pre-conditioning on JANTX parts (vs no pre-conditioning of JAN parts) has resulted in a significant improvement in field reported failure rates.

National Semiconductor also offers JANTXV types (JANTX with 100% preseal visual inspection per MIL-STD-750 Method 2072) per the above list.

All hermetically sealed transistors in this catalog (where JANTX or JANTXV specifications do not exist) are available with TX and TXV type 100% processing as NX and NXV types respectively; e.g., NX2N4033 is 2N4033 processed per the flow plans on this page.

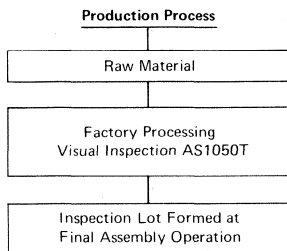

### 100% Process Conditioning

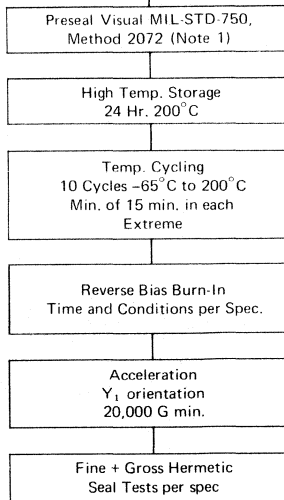

### 100% Burn-In (Note 3)

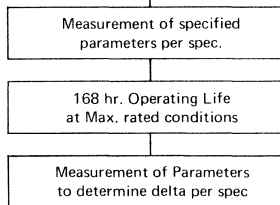

### Inspection Test to Verify LTPD

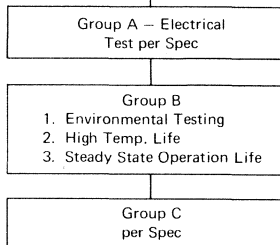

**Note 1:** JANTXV types only.

**Note 2:** JANTX and JANTXV types only.

**Note 3:** MIL-STD-19500 was under revision at the time of the publication of this document. Contact the factory for information regarding any changes made by this revision.

## Bipolar Transistor and FET Dice

### DICE

Standard types from National's transistor families are available in unencapsulated die form for use in hybrid circuits.

### FEATURES

- 100% probed and guaranteed to 10% LTPD for key 2N parameters.
  - a.  $BVC_{BO}$ ,  $BV_{CEO}$ ,  $BV_{EBO}$  and  $h_{FE}$  for bipolar transistors.
  - b.  $BV_{GSS}$ ,  $I_{DSS}$ ,  $I_{GSS}^*$ ,  $R_{ON}^*$ ,  $Y_{fs}$ ,  $V_{GS(off)}$  for FETs.
- Minimum 60% yield to all unprobed 2N parameters.
- 100% visual inspection guaranteed to 10% LTPD for criteria equivalent to MIL-STD-883 Method 2010.
- Gold backing on all types.
- Shipment in waffle carriers.
- Die geometries shown in process section of catalog. Base Pad is identified by adjacent metallized circle on all interdigitated geometries (e.g., see Process 21).

**ALL STANDARD TYPES** (see index for page listing specification)

**\*FET NOTE:**

Leakages ( $I_{GSS}$ )	$\leq 100 \text{ pA}$	10% AQL
$R_{DS(on)}$	$\leq 10\Omega$	10% AQL

## Bipolar Transistor Equivalents List

METAL P/N	PLASTIC EQUIVALENT	ELECTRICAL EQUIVALENCY*	PROCESS	METAL P/N	PLASTIC EQUIVALENT	ELECTRICAL EQUIVALENCY*	PROCESS
2N697	2N4400	A	13	2N2904A	TN2904A	E	63
2N706	MPS706	E	21	2N2905	TN2905	E	63
2N708	MPS3646	N	22	2N2905A	TN2905A	E	63
2N718	2N4400	A	13	2N2906	PN2906	E	63
2N722	PN2906	N	63	2N2906A	PN2906A	E	63
2N744	PN2369	N	21	2N2907	PN2907	E	63
2N753	PN2369	N	21	2N2907A	PN2907A	E	63
2N760A	2N4409	N	07	2N3009	MPS3646	N	22
2N834	MPS834	E	21	2N3011	PN2369	N	21
2N869A	MPS3640	A	65	2N3012	MPS3640	A	65
2N915	MPS6565	A	27	2N3013	MPS3646	E	22
2N917	MPS3563	E	43	2N3019	TN3019	E	12
2N918	PN918	E	43	2N3020	TN3020	E	12
2N929	2N4409	N	07	2N3053	TN3053	E	12
2N930	PN930	E	07	2N3117	2N5210	N	07
2N956	PN2222A	N	19	2N3133	MPS3703	N	63
2N995A	MPS3640	A	65	2N3134	MPS3645	N	63
2N1132	PN2906	N	63	2N3135	MPS3703	N	63
2N1613	PN2221A	N	19	2N3136	MPS3645	N	63
2N1711	PN2222A	N	19	2N3250	2N3905	A	66
2N2218	TN2218	E	19	2N3251	2N3906	A	66
2N2218A	TN2218A	E	19	2N3300	2N4401	A	13
2N2219	TN2219	E	19	2N3301	2N4400	A	13
2N2219A	TN2219A	E	19	2N3302	2N4401	A	13
2N2221	PN2221	E	19	2N3304	MPS3639	A	65
2N2221A	PN2221A	E	19	2N3724	TN3724	E	25
2N2222	PN2222	E	19	2N3725	TN3725	E	25
2N2222A	PN2222A	E	19	2N3944	2N3903	N	23
2N2369	PN2369	E	21	2N3947	2N3904	N	23
2N2369A	PN2369A	E	21	2N3962	2N5086	N	62
2N2483	2N5209	N	07	2N3964	2N5087	N	62
2N2484	2N5210	N	07	2N3965	2N5087	N	62
2N2604	2N5086	N	62	2N4033	TN4033	E	67
2N2605	2N5086	N	62	2N4036	TN4036	E	67
2N2894	MPS3640	A	65	2N4037	TN4037	E	67
2N289A	MPS3639	A	65	2N4208	MPS3640	N	65
2N2904	TN2904	E	63	2N4209	MPS3640	N	65

\*E = Exact electrical equivalent

N = Near electrical equivalent

A = Approximate equivalent

**Note:** On "N" and "A" categories please refer to device specification section for deviation from metal can specifications.

This list is for use when an alternative to a metal can transistor is needed.

To facilitate conversions on the most popular types National is offering the "PN" series, TO-92 devices that use the same die type and are screened to same electrical specifications. The TO-92 transistors produced by National Semiconductor are the most advanced Plastic Transistors ever manufactured. They utilize epoxy B encapsulation and a copper lead frame, to give a power dissipation of 625 mW @  $T_A = 25^\circ\text{C}$ . These transistors provide electrical performance and reliability equivalent to their metal can versions in most applications where  $T_A$  does not exceed  $150^\circ\text{C}$ .

# Conversion of TO-105/TO-106 to TO-92

National has chosen to no longer produce the TO-105/106 plastic transistor line. The decision to drop this line was based on two major factors: cost and performance.

The TO-92 is the most advanced transistor offered today. With its automated assembly, it has the lowest potential cost. By contrast, the TO-105/106 is a hand-assembled product and its cost is tied to ever-increasing labor costs. One can save 20% to 50% by using TO-92 equivalents.

Our TO-92 is encapsulated in "Epoxy B" and has a copper lead frame. This is *the* superior TO-92 available today. As compared with TO-105/106, our TO-92 has better than twice the power dissipation of either package.

We have done several things in order to make this conversion as easy as possible. We are offering a

series on "PN" ("PN" and "J" in FETs) part numbers that have exactly the same number as the original part; i.e., 2N3565 becomes a PN3565. These PN types use the same chip and are screened to the same electrical specification as the original part. The original parts have a pin circle, TO-106 = TO-18 and TO-105 = TO-5, so we will supply TO-92 lead formed to the appropriate configuration at no extra charge. If you enter an order to the old part number, our computer will automatically convert it to the correct PN number *with* the correct lead form; i.e., 2N3565 becomes PN3565-18. In the case of some of the less popular types, we have converted to the nearest part type using the same chip. Please use the conversion chart on the next page as a guide.

It is our intent to service our customers with the highest quality and most cost-effective product available.

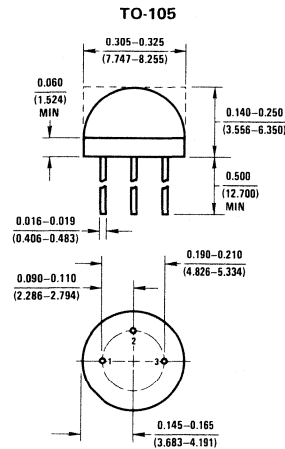

PIN	T
1	E
2	B
3	C

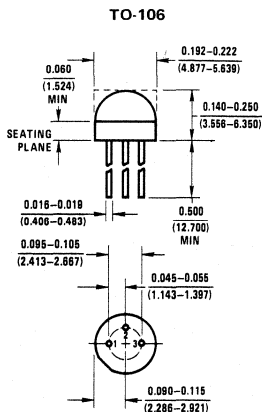
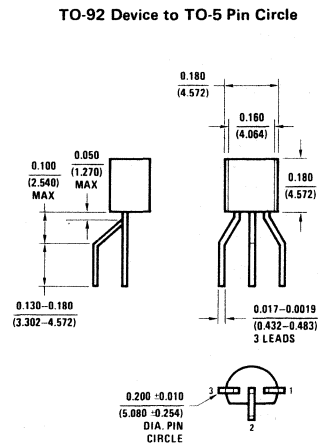

PIN	FET	T
1	S	E
2	D	B
3	G	C

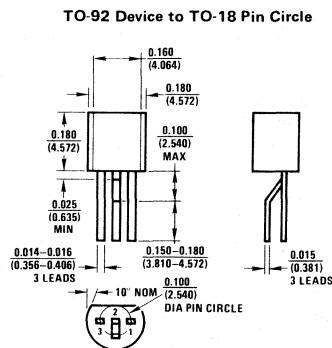

# Conversion of TO-105/TO-106 to TO-92 (Continued)

Conversion of TO-105/TO-106 to TO-92

## Bipolar

TO-105/106	TO-92	TO-105/106	TO-92	TO-105/106	TO-92
EN2222	PN2222-18	2N3692	PN3692-18	2N4965	2N5086-18
EN2369A	PN2369A-18	2N3693	MPS3693-18	2N4966	2N5209-18
EN2484	PN2484-18	2N3694	PN3694-18	2N4967	2N5210-18
3N2907	PN2907-18	2N4121	PN4121-18	2N4968	2N5209-18
EN918	PN918-18	2N4122	PN4122-18	2N4969	PN2221-18
EN930	PN930-18	2N4140	PN4140-18	2N4970	PN2222-18
SM3904	2N3904-18	2N4141	PN4141-18	2N4971	PN2906-18
SM3906	2N3906-18	2N4142	PN4142-18	2N4972	PN2907-18
2N3563	PN3563-18	2N4143	PN4143-18	2N5127	PN5127-18
2N3564	PN3564-18	2N4248	PN4248-18	2N5128	PN5128-5
2N3565	PN3565-18	2N4249	PN4249-18	2N5129	PN5129-18
2N3566	PN3566-5	2N4250	PN4250-18	2N5130	PN5130-18
2N3567	PN3567-5	2N4250A	PN4250A-18	2N5131	PN5131-18
2N3568	PN3568-5	2N4258	PN4258-18	2N5132	PN5132-18
2N3569	PN3569-5	2N4258A	PN4258A-18	2N5133	PN5133-18
2N3638	PN3638-5	2N4274	PN4274-18	2N5134	PN5134-18
2N3638A	PN3638A-5	2N4275	PN4275-18	2N5135	PN5135-18
2N3639	PN3639-18	2N4354	PN4354-5	2N5136	PN5136-5
2N3640	PN3640-18	2N4355	PN4355-5	2N5137	PN5137-18
2N3641	PN3641-5	2N4356	PN4356-5	2N5138	PN5138-18
2N3642	PN3642-5	2N4916	PN4916-18	2N5139	PN5139-18
2N3643	PN3643-5	2N4917	PN4917-18	2N5142	PN5142-18
2N3644	PN3644-5	2N4944	PN2222A-18	2N5143	PN5143-18
2N3645	PN3645-5	2N4945	PN2222A-18	2N5910	PN5910-18
2N3646	PN3646-18	2N4946	PN2222A-18		
2N3691	PN3691-18	2N4964	MPSA70-18		

## FETs

TO-106	TO-92	TO-106	TO-92	TO-106	TO-92
E100	J203-18	E300	J300-18	KE4393	PN4393-18
E101	J201-18	E304	J304-18	KE4416	PN4416-18
E102	J202-18	E305	J305-18	KE4857	PN4857-18
E103	J203-18	E308	J308-18	KE4858	PN4858-18
E108	J108-18	E309	J309-18	KE4859	PN4859-18
E109	J109-18	E310	J310-18	KE4860	PN4860-18
E110	J110-18	E311	J309-18	KE4861	PN4861-18
E111	J111-18	E312	J310-18	ITE4391	PN4391-18
E112	J112-18	KE3684	PN3684-18	ITE4392	PN4392-18
E113	J113-18	KE3685	PN3685-18	ITE4393	PN4393-18
E114	J114-18	KE3686	PN3686-18	P1086E	P1086E
E174	J174-18	KE3687	PN3687-18	P1087E	P1087E
E175	J175-18	KE4091	PN4091-18	U1897E	U1897E
E176	J176-18	KE4092	PN4092-18	U1898E	U1898E
E201	J201-18	KE4093	PN4093-18	U1899E	U1899E
E202	J202-18	KE4220	PN4220-18	2N4302	PN4302-18
E203	J203-18	KE4221	PN4221-18	2N4303	PN4303-18
E210	J210-18	KE4222	PN4222-18	2N4304	PN4304-18
E211	J211-18	KE4223	PN4223-18	2N4342	PN4342-18
E212	J212-18	KE4224	PN4224-18	2N4343	PN4343-18
E270	J270-18	KE4391	PN4391-18	2N4360	PN4360-18
E271	J271-18	KE4392	PN4392-18	2N5033	PN5033
				2N5163	PN5163



# Choose The Proper FET

National Semiconductor utilizes 17 different FET geometries to cover, without compromise, the full spectrum of applications. Detailed data on each process, along with a list of all part numbers manufactured from each process, is to be found in Section 9.

To further simplify the selection procedure, the FET Family Tree is included for quick identification. After narrowing down the process types, it is suggested that the process sheets and specific part number characteristics be consulted.

## FET FAMILY TREE

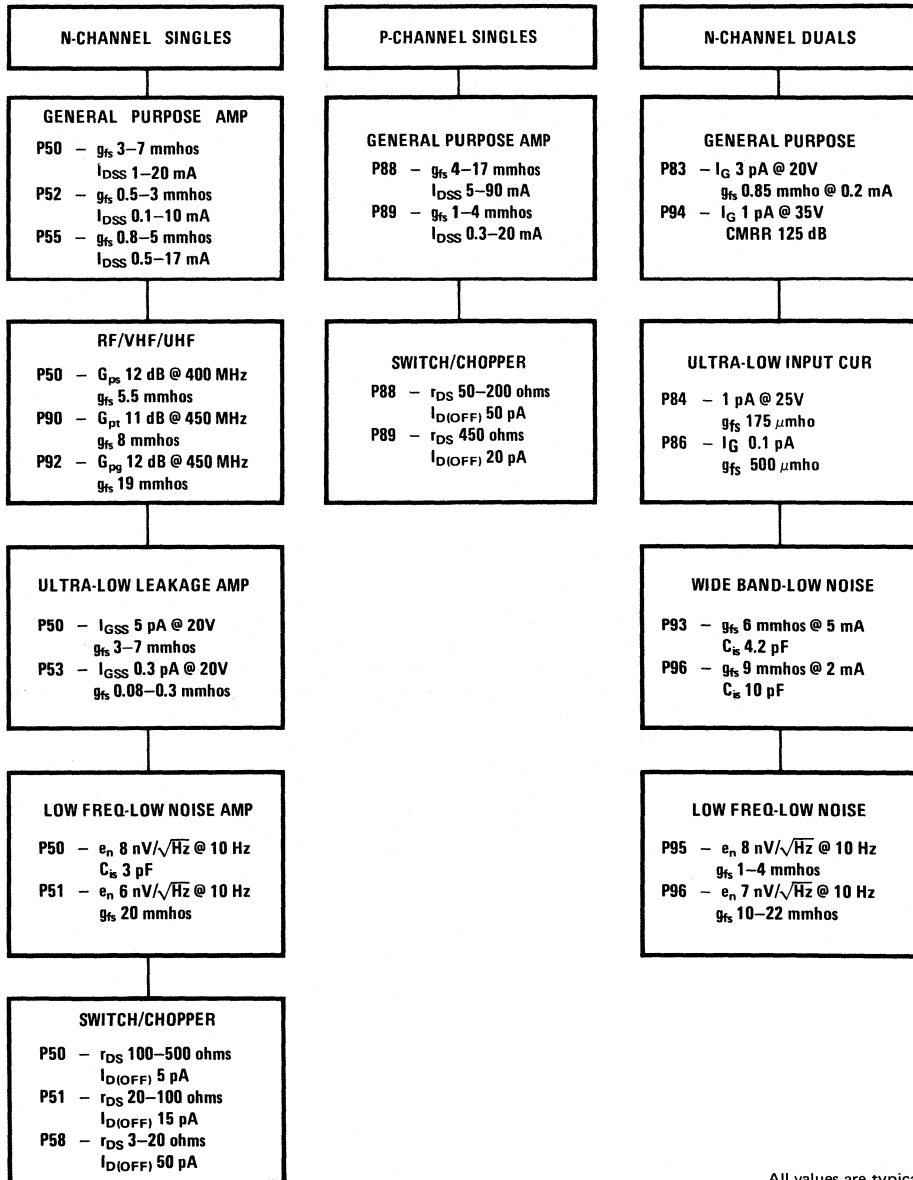

All values are typical

# FET Application Guide

National Semiconductor manufactures a broad line of silicon Junction Field Effect Transistors (JFETs). National's JFETs provide excellent performance in many areas such as RF amplifiers, analog switching, low input current amplifiers, low noise high impedance amplifiers and outstanding matched duals for operational amplifiers input applications.

The following FET guides enable the user to determine when to use FETs and where to look for the best choice.

POPULAR PRODUCT TYPES	2N4416, 2N5485, 6 PN4416, PN4302-4 2N4856-61, 2N4391-3 PN4856-61, PN4391-3 2N4338-41, 2N3684-7 2N4117-9, 2N3452-4 2N4117A-19A 2N3821-2, 2N4221-2 2N5457-9 2N5432-4 2N5196-9, 2N5545-7 2N3954-8 2N5902-9 U421-U426 2N5018-21, P1086-7E 2N5114-6 2N2608-9, 2N5460-62 2N5397, J300 U308-10, J308-10 2N5911-12 NDF9401-10 2N5515-24, 2N6483-5 2N5564-6 2N5561-63																		
PROCESS DESIGNATION	50	51	52	53	55	58	83	84	86	88	88	90	92	93	94	95	96	98	
Low Current Amplifier			S	P	S		P	P	P							P	P		P
Low Freq Ampli ≤ 100 Hz			S		S		P				S	S				P	P		P
High Freq Ampli > 100 MHz	P											P	P	P				P	
General Purpose Amplifier	P		P		P							P							
Low Noise Amp (10 Hz e <sub>n</sub> )	S	S			S	S	P									P	P	P	P
Low Noise Amp > 50 MHz	P				S								P	P	P				P
High Frequency Mixer	P												P	P					
Dual Diff Pair							P	P	P						P	P	S	P	P
AGC Amplifier	P				P														
Electrometer Preamp				P				P	P							P			S
Microvolt Amplifier				P				P	P							P			P
Low Leakage Diode				P															
Diff/Angle Ended Inp. Stag.							P	P	P						P	P		P	P
Active Filter	P		S		P							S							
Oscillator	P		S		P							S	P	P					
Voltage Variable Resistor	P	P	S		P						P	P							P
Hybrid Chips	P	P		P	P		P	P	P	P	P	P				P			
Analog/Digital Switch		P				P					P							S	S
Multiplexing	P	P			S	S					P								
Choppers		P				P					P								P
Nixie Drivers																			
Reed Relay Replacement						P													
Sub pA Dual Diff Pair								P	P										
Sample-Hold	P	P			S				S	P									P
Buffer Interface to CMOS										P	P								
Matched Switch							S							S	S			P	P
HF ≥ 400 MHz Prime												P	P						
Current Limiter		P									P								
Current Source			P	S	P							S							

P — Prime Choice    S — Secondary (Alternate) Choice



# FET Application Guide (Continued)

## ADVANTAGES OF USING FIELD-EFFECT TRANSISTORS

APPLICATION	ADVANTAGES	FINAL ASSEMBLY WHERE USED
DC Amplifiers	High $Z_{in}$ Low drift duals Low noise	Transducers, military guidance systems, control systems, temp indicators, multimeters
Low frequency amplifiers	Small coupling capacitors Low noise, distortion High input impedance	Sound detection, microphones, inductive transducers, hearing aids, high impedance transducers
Operational amplifiers	Summing point essentially zero. Low device noise. Less loading of transducers	Control systems, potted op amps, test equipment, medical electronics
Medium and high frequency amplifiers	Low cross modulation Low device noise	FM tuners, communication received scope inputs, most instrumentation equipment, high impedance inputs
Mixers — 100 MHz and up	Low mixing noise Low cross modulation	FM tuners, communication receivers
Oscillators	Low drift	Transmitters, receivers, organ
Logic gates	Virtually infinite fan in Simplified circuitry Zero storage time Symmetrical	Guidance controls, computer market mini military teaching aids, traffic control, telemetry
Choppers	Zero offset Low leakage currents Simplified circuitry Eliminates input transformers	Op amp modules guidance controls instrumentation equipment
AD Converters Multiplex switching (arrays) and sample hold	Improved isolation of input and output. Zero offset. Symmetrical. Low resistance Simplified circuitry	Control system, DVM's and any read-out equipment, medical electronics
Relay contact replacement	Solid state reliability Zero offset, High isolation Symmetrical No inductive spring No contact bounce High repetition rate	Test equipment, airborne equipment instrumentation market
Voltage variable resistor	Symmetrical Solid state reliability Functions as variable resistor. Low noise. High isolation Improved resolution	Organ, tone controls, control ckts to input operational amplifiers
Current limiters Sources	Two lead simplicity Wide selection range Low voltage operation	Hybrid circuits, amplifiers, power supply protection, timing ckts, voltage regulators



# JFET Cross Reference Guide

This guide contains cross reference information to more than 850 Junction FETs, including many obsolete or otherwise unavailable types. Every effort has been made to recommend a replacement FET which will plug into an existing socket and work as well as the part it replaces. Let the replacement code be your guide. If you do not find a particular part in this guide and you know its specification, you should refer to "How To Use This Catalog" in this section.

## REPLACEMENT CODE

- \* Identical specification and pin configuration
  - Equal or better specification, identical pin configuration
  - Similar specification acceptable for all but the most critical applications, similar pin configuration
- CF Consult Factory or Local Sales Representative, available on special order
- N No equivalent process

INDUSTRY TYPE NUMBER	REPLACEMENT CODE	NATIONAL PART NUMBER
2N2386	■	2N2608
2N2386A	■	2N4381
2N2497	■	2N5021
2N2498	■	2N5021
2N2499	■	2N4381
2N2500	■	2N4381
2N2606	N	
2N2607	N	
2N2608	*	2N2608
2N2609	*	2N2609
2N2841	N	
2N2842	N	
2N2843	■	2N5020
2N2844	■	2N5020
2N3066	●	2N4340
2N3067	●	2N4338
2N3068	■	2N4338
2N3069	*	2N3069
2N3070	*	2N3070
2N3071	*	2N3071
2N3084	■	2N4340
2N3085	●	2N4340
2N3086	■	2N4340
2N3087	●	2N4340
2N3088	■	2N4339
2N3088A	■	2N4339
2N3089	●	2N4339
2N3089A	●	2N4339
2N3277	N	
2N3278	N	
2N3328	●	2N3330

INDUSTRY TYPE NUMBER	REPLACEMENT CODE	NATIONAL PART NUMBER
2N3329	*	2N3329
2N3330	*	2N3330
2N3331	*	2N3331
2N3332	*	2N3332
2N3365	■	2N4340
2N3366	■	2N4338
2N3367	■	2N4338
2N3368	*	2N3368
2N3369	*	2N3369
2N3370	*	2N3370
2N3376	●	2N3329
2N3378	■	2N3330
2N3380	●	2N3331
2N3382	*	2N3382
2N3384	*	2N3384
2N3386	*	2N3386
2N3436	*	2N3436
2N3437	*	2N3437
2N3438	*	2N3438
2N3452	■	2N3685
2N3453	■	2N4118
2N3454	■	2N4119
2N3455	■	2N3685
2N3456	■	2N4118
2N3457	■	2N4119
2N3458	*	2N3458
2N3459	*	2N3459
2N3460	*	2N3460
2N3574	■	2N3329
2N3575	■	2N3329
2N3578	●	2N2608
2N3684	*	2N3684
2N3684A	●	2N3684
2N3685	*	2N3685
2N3685A	●	2N3685
2N3686	*	2N3686
2N3686A	●	2N3686
2N3687	*	2N3687
2N3687A	●	2N3687
2N3819	*	2N3819
2N3820	*	2N3820
2N3821	*	2N3821
2N3822	*	2N3822
2N3823	*	2N3823
2N3824	*	2N3824
2N3909	●	2N3331
2N3909A	●	2N3331
2N3921	*	2N3921
2N3922	*	2N3922
2N3954	*	2N3954
2N3954A	*	2N3954A
2N3955	*	2N3955
2N3955A	*	2N3955A
2N3956	*	2N3956
2N3957	*	2N3957
2N3958	*	2N3958
2N3966	*	2N3966

# JFET Cross Reference Guide (Continued)

INDUSTRY TYPE NUMBER	REPLACEMENT CODE	NATIONAL PART NUMBER	INDUSTRY TYPE NUMBER	REPLACEMENT CODE	NATIONAL PART NUMBER
2N3967	*	2N3967	2N4856	*	2N4856
2N3967A	*	2N3967A	2N4856A	*	2N4856A
2N3968	*	2N3968	2N4857	*	2N4857
2N3968A	*	2N3968A	2N4857A	*	2N4857A
2N3969	*	2N3969	2N4858	*	2N4858
2N3969A	*	2N3969A	2N4858A	*	2N4858A
2N3970	*	2N3970	2N4859	*	2N4859
2N3971	*	2N3971	2N4859A	*	2N4859A
2N3972	*	2N3972	2N4860	*	2N4860
2N3993	*	2N3993	2N4860A	*	2N4860A
2N3993A	*	2N3993A	2N4861	*	2N4861
2N3994	*	2N3994	2N4861A	*	2N4861A
2N3994A	*	2N3994A	2N4867	CF	
2N4082	CF		2N4867A	CF	
2N4083	CF		2N4868	CF	
2N4084	*	2N4084	2N4868A	CF	
2N4085	*	2N4085	2N4869	CF	
2N4091	*	2N4091	2N4869A	CF	
2N4092	*	2N4092	2N4881	N	
2N4093	*	2N4093	2N4882	N	
2N4117	*	2N4117	2N4883	N	
2N4117A	*	2N4117A	2N4884	N	
2N4118	*	2N4118	2N4885	N	
2N4118A	*	2N4118A	2N4886	N	
2N4119	*	2N4119	2N4977	■	2N5432
2N4119A	*	2N4119A	2N4978	■	2N5433
2N4139	CF		2N4979	■	2N5434
2N4220	*	2N4220	2N5018	*	2N5018
2N4220A	*	2N4220A	2N5019	*	2N5019
2N4221	*	2N4221	2N5020	*	2N5020
2N4221A	*	2N4221A	2N5021	*	2N5021
2N4222	*	2N4222	2N5033	●	PN5033
2N4222A	*	2N4222A	2N5045	*	2N5045
2N4223	*	2N4223	2N5046	*	2N5046
2N4224	*	2N4224	2N5047	*	2N5047
2N4302	●	PN4302	2N5078	*	2N5078
2N4303	●	PN4303	2N5103	*	2N5103
2N4304	●	PN4304	2N5104	*	2N5104
2N4338	*	2N4338	2N5105	*	2N5105
2N4339	*	2N4339	2N5114	*	2N5114
2N4340	*	2N4340	2N5115	*	2N5115
2N4341	*	2N4341	2N5116	*	2N5116
2N4342	●	PN4342	2N5163	*	2N5163
2N4343	CF		2N5196	*	2N5196
2N4360	●	PN4360	2N5197	*	2N5197
2N4381	*	2N4381	2N5198	*	2N5198
2N4382	■	2N5115	2N5199	*	2N5199
2N4391	*	2N4391	2N5245	*	2N5245
2N4392	*	2N4392	2N5246	*	2N5246
2N4393	*	2N4393	2N5247	*	2N5247
2N4416	*	2N4416	2N5248	*	2N5248
2N4416A	*	2N4416A	2N5265	CF	
2N4417	N		2N5266	CF	
2N4445	●	2N5432	2N5267	CF	
2N4446	●	2N5433	2N5268	CF	
2N4447	●	2N5432	2N5269	CF	
2N4448	●	2N5433	2N5270	CF	

# JFET Cross Reference Guide (Continued)

INDUSTRY TYPE NUMBER	REPLACEMENT CODE	NATIONAL PART NUMBER	INDUSTRY TYPE NUMBER	REPLACEMENT CODE	NATIONAL PART NUMBER
2N5277	N		2N5555	*	2N5555
2N5278	N		2N5556	*	2N5556
2N5358	*	2N5358	2N5557	*	2N5557
2N5359	*	2N5359	2N5558	*	2N5558
2N5360	*	2N5360	2N5561	*	2N5561
2N5361	*	2N5361	2N5562	*	2N5562
2N5362	*	2N5362	2N5563	*	2N5563
2N5363	*	2N5363	2N5564	*	2N5564
2N5364	*	2N5364	2N5565	*	2N5565
2N5391	CF		2N5566	*	2N5566
2N5392	CF		2N5638	*	2N5638
2N5393	CF		2N5639	*	2N5639
2N5394	CF		2N5640	*	2N5640
2N5395	CF		2N5647	■	2N3686
2N5396	CF		2N5648	■	2N3686
2N5397	*	2N5397	2N5649	■	2N3685
2N5398	*	2N5398	2N5653	*	2N5653
2N5432	*	2N5432	2N5654	*	2N5654
2N5433	*	2N5433	2N5668	*	2N5668
2N5434	*	2N5434	2N5669	*	2N5669
2N5452	*	2N5452	2N5670	*	2N5670
2N5453	*	2N5453	2N5902	*	2N5902
2N5454	*	2N5454	2N5903	*	2N5903
2N5457	*	2N5457	2N5904	*	2N5904
2N5458	*	2N5458	2N5905	*	2N5905
2N5459	*	2N5459	2N5906	*	2N5906
2N5460	*	2N5460	2N5907	*	2N5907
2N5461	*	2N5461	2N5908	*	2N5908
2N5462	*	2N5462	2N5909	*	2N5909
2N5463	N		2N5911	*	2N5911
2N5464	N		2N5912	*	2N5912
2N5465	N		2N5949	*	2N5949
2N5471	■	2N5020	2N5950	*	2N5950
2N5472	■	2N5020	2N5951	*	2N5951
2N5473	■	2N5020	2N5952	*	2N5952
2N5474	■	2N5020	2N5953	*	2N5953
2N5475	■	2N5020	2N6449	N	
2N5476	■	2N5020	2N6450	N	
2N5484	*	2N5484	2N6451	CF	
2N5485	*	2N5485	2N6452	CF	
2N5486	*	2N5486	2N6453	CF	
2N5515	*	2N5515	2N6454	CF	
2N5516	*	2N5516	2N6483	*	2N6483
2N5517	*	2N5517	2N6484	*	2N6484
2N5518	*	2N5518	2N6485	*	2N6485
2N5519	*	2N5519	A5T6449	N	
2N5520	*	2N5520	A5T6450	N	
2N5521	*	2N5521	AD3954	●	2N3954
2N5522	*	2N5522	AD3954A	●	2N3954A
2N5523	*	2N5523	AD3955	●	2N3955
2N5524	*	2N5524	AD3955A	●	2N3955A
2N5543	N		AD3956	●	2N3956
2N5544	N		AD3957	●	2N3957
2N5545	*	2N5545	AD3958	●	2N3958
2N5546	*	2N5546	AD5905	●	2N5905
2N5547	*	2N5547	AD5906	●	2N5906
2N5549	●	2N5397	AD5907	●	2N5907

# JFET Cross Reference Guide (Continued)

INDUSTRY TYPE NUMBER	REPLACEMENT CODE	NATIONAL PART NUMBER	INDUSTRY TYPE NUMBER	REPLACEMENT CODE	NATIONAL PART NUMBER
AD5908	●	2N5908	E100	●	J202
AD5909	●	2N5909	E101	●	J201
AD830	■	2N5906	E102	●	J202
AD831	■	2N5907	E103	●	J203
AD832	■	2N5908	E105	N	
AD833	■	2N5909	E106	N	
AD833A	■	2N5909	E107	N	
AD835	■	NDF9407	E108	●	J108
AD836	■	NDF9408	E109	●	J109
AD837	■	NDF9408	E110	●	J110
AD838	■	NDF9409	E111	●	J111
AD839	■	NDF9410	E112	●	J112
AD840	■	2N5520	E113	●	J113
AD841	■	2N5521	E114	●	J114
AD842	■	2N5523	E174	●	J174
AD845	■	2N5911	E175	●	J175
AD846	■	2N5912	E176	●	J176
BF244A	*	BF244A	E177	●	J177
BF244B	*	BF244B	E201	●	J201
BF244C	*	BF244C	E202	●	J202
BF245A	*	BF245A	E203	●	J203
BF245B	*	BF245B	E210	●	J210
BF245C	*	BF245C	E211	●	J211
BF246A	*	BF246A	E212	●	J212
BF246B	*	BF246B	E230	■	PN3685
BF246C	*	BF246C	E231	■	PN3684
BF247A	*	BF247A	E232	■	PN368
BF247B	*	BF247B	E270	●	J270
BF247C	*	BF247C	E271	●	J271
BF256A	*	BF256A	E300	●	J300
BF256B	*	BF256B	E304	●	J304
BF256C	*	BF256C	E305	●	J305
BF264A	*	BF264A	E308	●	J308
BF264B	*	BF264B	E309	●	J309
BF264C	*	BF264C	E310	●	J310
BF264D	*	BF264D	E311	●	J309
C413N	●	2N4859	E312	●	J310
C681	■	2N4338	E400	CF	
C681A	■	2N4338	E401	CF	
C683	■	2N4339	E402	CF	
C683A	■	2N4339	E410	CF	
C685	■	2N4220	E411	CF	
C685A	■	2N4220	E412	CF	
CM640	■	2N4391	E420	■	U257
CM641	■	2N4391	E421	■	U257
CM642	■	2N4392	FEO654A	●	PN4416
CM643	■	2N4391	FEO654B	●	PN4303
CM644	■	2N4393	FE3819	●	2N3819
CM645	■	2N4392	FE5245	●	2N5245
CM646	■	2N4392	FE5246	●	2N5246
CM647	■		FE5247	●	2N5247
CP640	●	U322	FE5457	●	2N5457
CP643	■	2N4391	FE5458	●	2N5458
CP650	●	U322	FE5459	●	2N5459
CP651	●	U320	FE5484	●	2N5484
CP652	●	U322	FE5485	●	2N5485
CP653	●	U320	FE5486	●	2N5486

# JFET Cross Reference Guide (Continued)

INDUSTRY TYPE NUMBER	REPLACEMENT CODE	NATIONAL PART NUMBER	INDUSTRY TYPE NUMBER	REPLACEMENT CODE	NATIONAL PART NUMBER
FM1100A	■	2N5906	J114	*	J114
FM1101A	■	2N5906	J174	*	J174
FM1102A	■	2N5907	J175	*	J175
FM1103A	■	2N5908	J176	*	J176
FM1104A	■	2N5909	J177	*	J177
FM105A	■	NDF9401	J201	*	J201
FM1106A	■	NDF9401	J202	*	J202
FM1107A	■	NDF9402	J203	*	J203
FM1108A	■	NDF9403	J270	*	J270
FM1109A	■	NDF9405	J271	*	J271
FM1110A	■	2N3957	J300	*	J300
FM1111A	■	2N3958	J304	*	J304
FM3954	●	2N3954	J305	*	J305
FM3954A	●	2N3954A	J401	*	J401
FM3955	●	2N3955	J402	*	J402
FM3955A	●	2N3955A	J403	*	J403
FM3956	●	2N3956	J404	*	J404
FM3957	●	2N3957	J405	*	J405
FM3958	●	2N3958	J406	*	J406
FT0654A	■	2N3824	J410	*	J410
FT0654B	■	2N3824	J411	*	J411
FT0654C	■	2N4221	J412	*	J412
FT3820	●	2N3820	J1401	*	J1401
IMF3954	●	2N3954	J1402	*	J1402
IMF3954A	●	2N3954A	J1403	*	J1403
IMF3955	●	2N3955	J1404	*	J1404
IMF3955A	●	2N3955A	J1405	*	J1405
IMF3956	●	2N3956	J1406	*	J1406
IMF3957	●	2N3957	KE3684	●	PN3684
IMF3958	●	2N3958	KE3685	●	PN3685
IT100	■	2N5115	KE3686	●	PN3686
IT101	■	2N5116	KE3970	●	PN4391
IT108	●	2N5486	KE3971	●	PN4392
IT109	●	2N5397	KE3972	●	PN4393
ITE3066	■	2N4340	KE4091	●	PN4091
ITE3067	■	2N4338	KE4092	●	PN4092
ITE3068	■	2N4338	KE4093	●	PN4093
ITE4117	■	2N4117	KE4220	●	PN4220
ITE4118	●	2N4118	KE4221	●	PN4221
ITE4119	●	2N4119	KE4222	●	PN4222
ITE4338	●	2N4338	KE4223	●	PN4223
ITE4339	●	2N4339	KE4224	●	PN4224
ITE4340	●	2N4340	KE4391	●	PN4391
ITE4341	●	2N4391	KE4392	●	PN4392
ITE4391	*	PN4391	KE4393	●	PN4393
ITE4392	*	PN4392	KE4416	●	PN4416
ITE4393	●	PN4393	KE4856	●	PN4856
ITE4416	●	PN4416	KE4857	●	PN4857
ITE4867	■	PN3686	KE4858	●	PN4858
ITE4868	■	PN3685	KE4859	●	PN4859
ITE4869	■	PN3684	KE4860	●	PN4860
J108	*	J108	KE4861	●	PN4861
J109	*	J109	KE5103	●	2N5952
J110	*	J110	KE5104	●	2N5953
J111	*	J111	KE5105	■	PN4416
J112	*	J112	MFE2000	■	2N4416
J113	*	J113	MFE2001	■	2N4416

# JFET Cross Reference Guide (Continued)

INDUSTRY TYPE NUMBER	REPLACEMENT CODE	NATIONAL PART NUMBER	INDUSTRY TYPE NUMBER	REPLACEMENT CODE	NATIONAL PART NUMBER
MFE2004	■	2N4393	NF532	●	2N3822
MFE2005	■	2N4392	NF533	●	2N3821
MFE2006	■	2N4391	NF580	●	2N5432
MFE2007	■	2N4857	NF581	●	2N5432
MFE2008	■	2N4391	NF582	●	2N5434
MFE2009	■	2N4856	NF583	●	2N5434
MFE2010	■	2N4856	NF584	●	2N5432
MFE2011	■	2N5433	NF585	●	2N5433
MFE2012	■	2N5433	NF4302	●	PN4302
MFE2093	■	2N3687	NF4303	●	PN4303
MFE2094	■	2N3686	NF4304	●	PN4304
MFE2095	■	2N3685	NF4445	●	2N5432
MFE2133	■	2N4392	NF4446	●	2N5433
MFE4007	■	2N2608	NF4447	●	2N5432
MFE4008	■	2N2608	NF4448	●	2N5433
MFE4009	■	2N3329	NF5101	*	NF5101
MFE4010	■	2N3330	NF5102	*	NF5102
MFE4011	■	2N3330	NF5103	*	NF5103
MFE4012	■	2N3331	NF5163	●	2N5163
MPP102	*	MPP102	NF5457	●	2N5457
MPP103	*	MPP103	NF5458	●	2N5458
MPP104	*	MPP104	NF5459	●	2N5459
MPP105	*	MPP105	NF5485	●	2N5485
MPP106	*	MPP106	NF5486	●	2N5486
MPP107	*	MPP107	NF5555	●	2N5555
MPP108	*	MPP108	NF5638	●	2N5638
MPP109	*	MPP109	NF5639	●	2N5639
MPP111	*	MPP111	NF5640	●	2N5640
MPP112	*	MPP112	NF5653	●	2N5653
MPP161	●	2N5461	NF5654	●	2N5654
MPP256	●	J211	NPD5564	*	NPD5564
MPP820	■	J309	NPD5565	*	NPD5565
MPP970	●	P1086E	NPD5566	*	NPD5566
MPP971	●	P1087E	NPD8301	*	NPD8301
MPP4391	*	PN4391	NPD8302	*	NPD8302
MPP4392	*	PN4392	NPD8303	*	NPD8303
MPP4393	*	PN4393	NPD9801	*	NPD9801
NDF9401	*	NDF9401	NPD9802	*	NPD9802
NDF9402	*	NDF9402	NPD9803	*	NPD9803
NDF9403	*	NDF9403	P1069E		
NDF9404	*	NDF9404	P1086E	*	P1086E
NDF9405	*	NDF9405	P1087E	*	P1087E
NDF9406	*	NDF9406	P1117E	CF	
NDF9407	*	NDF9407	P1118E	CF	
NDF9408	*	NDF9408	P1119E	CF	
NDF9409	*	NDF9409	PF510	●	PN4392
NDF9410	*	NDF9410	PF511	●	PN4392
NF500	●	2N4224	PF5101	*	PF5101
NF501	●	2N4224	PF5102	*	PF5102
NF506	●	2N3823	PF5103	*	PF5103
NF510	●	2N4092	PN3684	*	PN3684
NF520	●	2N4224	PN3685	*	PN3685
NF521	●	2N4220	PN3686	*	PN3686
NF522	●	2N4224	PN3687	*	PN3687
NF523	●	2N4220	PN4091	*	PN4091
NF530	●	2N3822	PN4092	*	PN4092
NF531	●	2N3821	PN4093	*	PN4093



# JFET Cross Reference Guide (Continued)

INDUSTRY TYPE NUMBER	REPLACEMENT CODE	NATIONAL PART NUMBER	INDUSTRY TYPE NUMBER	REPLACEMENT CODE	NATIONAL PART NUMBER
PN4220	*	PN4220	TD5906A	■	2N5906
PN4221	*	PN4221	TD5907	■	2N5907
PN4222	*	PN4222	TD5907A	■	2N5907
PN4223	*	PN4223	TD5908	■	2N5908
PN4224	*	PN4224	TD5908A	■	2N5908
PN4302	*	PN4302	TD5909	■	2N5909
PN4303	*	PN4303	TD5909A	■	2N5909
PN4304	*	PN4304	TD5911	■	2N5911
PN4342	*	PN4342	TD5911A	■	2N5911
PN4343	■	P1087E	TD5912	■	2N5912
PN4360	*	PN4360	TD5912A	■	2N5912
PN4391	*	PN4391	TIS25	N	
PN4392	*	PN4392	TIS26	N	
PN4393	*	PN4393	TIS27	N	
PN4416	*	PN4416	TIS34	●	2N5486
PN4856	*	PN4856	TIS41	■	2N4859
PN4857	*	PN4857	TIS42	■	PN4392
PN4858	*	PN4858	TIS58	*	TIS58
PN4859	*	PN4859	TIS59	*	TIS59
PN4860	*	PN4860	TIS68	N	
PN4861	*	PN4861	TIS69	N	
PN5033	*	PN5033	TIS70	N	
PN5163	*	PN5163	TIS73	*	TIS73
SU2078	●	2N3955	TIS74	*	TIS74
SU2079	●	2N3956	TIS75	*	TIS75
SU2080			TIS78	N	
SU2081			TIS79	N	
SU2098	●	2N3954	TIS88A	●	2N5486
SU2098A	●	2N3954	U110	■	2N5020
SU2098B	●	2N3954A	U112	●	2N4381
SU2099	●	2N3955A	U114	■	2N5020
SU2099A	●	2N3955A	U133	■	2N5020
SU2365	●	U401	U146	●	2N5020
SU2365A	●	U401	U147	●	2N5020
SU2366	●	U402	U148	●	2N2608
SU2366A	●	U402	U149	●	2N2609
SU2367	●	U403	U168	●	2N2608
SU2367A	●	U403	U182	●	2N4857
SU2368	●	U404	U183	●	2N3823
SU2368A	●	U404	U184	●	2N4416
SU2369	●	U405	U197	●	2N4338
SU2369A	●	U405	U198	●	2N4340
SU2410	■	U424	U199	●	2N4341
SU2411	■	U425	U200	●	2N4393
SU2412	■	U426	U201	●	2N4392
TD5452	■	2N5452	U202	●	2N4391
TD5453	■	2N5453	U231	*	U231
TD5454	■	2N5454	U232	*	U232
TD5902	■	2N5902	U233	*	U233
TD5902A	■	2N5902	U234	*	U234
TD5903	■	2N5903	U235	*	U235
TD5903A	■	2N5903	U240	●	2N5432
TD5904	■	2N5904	U241	●	2N5433
TD5904A	■	2N5904	U242	●	2N5432
TD5905	■	2N5905	U243	●	2N5433
TD5905A	■	2N5905	U244	N	
TD5906	■	2N5906	U248	*	2N5902

# JFET Cross Reference Guide (Continued)

INDUSTRY TYPE NUMBER	REPLACEMENT CODE	NATIONAL PART NUMBER	INDUSTRY TYPE NUMBER	REPLACEMENT CODE	NATIONAL PART NUMBER
U248A	*	2N5906	U1897E	●	U1897E
U249	*	2N5903	U1898E	●	U1898E
U249A	*	2N5907	U1899E	●	U1899E
U250	*	2N5904	U1994E	●	PN4416
U250A	*	2N5908	U2047	●	PN4416
U251	*	2N5905	UC155	■	2N4416
U251A	*	2N5909	UC200	■	2N4393
U252	*	2N5911	UC201	■	2N4416
U253	*	2N5912	UC210	■	2N3822
U254	*	2N4859	UC220	■	2N4220
U255	*	2N4860	UC241	■	2N3822
U256	*	2N4861	UC250	●	2N4391
U257	●	U257	UC251	●	2N4392
U266	N		UC400	■	2N2609
U280	●	2N3954	UC401	■	2N5019
U281	●	2N3954	UC410	■	2N2609
U282	●	2N3955	UC420	■	2N3329
U283	●	2N3955	UC588	■	2N4416
U284	●	2N3956	UC703	■	2N3822
U285	●	2N3957	UC705	■	2N3824
U290	N		UC707	■	2N4391
U291	N		UC714	■	2N4416
U300	■	U304	UC734	■	2N4416
U301	*	U301	UC734E	■	PN4416
U304	●	2N5114	UC755	■	2N4391
U305	●	2N5116	UC756	■	2N4224
U306	●	2N5117	UC805	■	2N3331
U308	*	U308	UC807	■	2N4861
U309	*	U309	UC814	■	2N3331
U310	*	U310	UC851	■	2N2608
U311	●	U311	UC854	CF	
U312	*	U312	UC855	CF	
U320	*	U320	UC2139	CF	
U321	*	U321	UC2147	CF	
U322	*	U322	UC2148	CF	
U328	N		UC2149	CF	
U329	N		VCR2N	■	2N4092
U330	N		VCR3P	■	2N5115
U331	N		VCR4N	■	2N4341
U350	*	U350	VCR5P	■	2N3331
U401	*	U401	VCR7N	■	2N4119
U402	*	U402			
U403	*	U403			
U404	*	U404			
U405	*	U405			
U406	*	U406			
U421	*	U421			
U422	*	U422			
U423	*	U423			
U424	*	U424			
U425	*	U425			
U426	*	U426			
U430	*	U430			
U431	*	U431			
U1714	●	2N4340			
U1715	N				
U1837E	●	2N5486			

# RF Selector Guide

	BIPOLARS								JFET'S		
	41	42	43	44	45	46	47	49	50	90	92
<b>Preamplifiers</b>											
> 500 MHz	•										
> 500 MHz with AGC	•										
200–500 MHz	•	•							•	•	
200–500 MHz with AGC	•										
50–250 MHz		•		•					•	•	•
50–250 MHz with AGC	•			•							
20–120 MHz				•				•	•	•	
<b>Mixers</b>											
Input > 500 MHz	•										
Input 200–500 MHz		•					•		•	•	•
Input 50–250 MHz				•			•	•	•	•	
Input 20–120 MHz						•	•	•	•	•	
<b>Loc Osc</b>											
> 500 MHz Mech. Tuned		•	•								
> 500 MHz Varactor		•									
200–500 MHz Mech. Tuned			•				•				
200–500 MHz Varactor							•				
50–250 MHz			•				•				
20–120 MHz			•								
<b>IF Amps</b>											
< 75 MHz					•	•	•	•	•	•	
< 15 MHz			•			•	•		•		
< 75 MHz with AGC				•	•						
< 15 MHz with AGC				•							
< 75 MHz Last Stage						•	•	•			
< 15 MHz Last Stage						•		•	•		
<b>Special Uses</b>											
200–500 MHz < 1.0 mA Bias		•									
50–250 MHz < 1.0 mA Bias		•					•				
200–500 MHz 5–15 mA Linear IF		•									
50–250 MHz 5–15 mA Linear IF							•				•
< 120 MHz/20 mA Wideband RF							•				•
VHF Freq. Generator and/or Multiplier to 75 mW Levels			•								

# Transistors NPN GPA Devices

CONTINUOUS OPERATION TYPICAL COLLECTOR CURRENT	15 V	20 V	25 V	30 V	35 V	40 V	45 V	60 V	80 V	100 V	120 V	220 V	300 V
100 mA	<p>P27 GPA-AUDIO DRIVER 200 MHz NSDU01 DW</p>												
80 mA	<p>P09 AUDIO GPA 400 MHz PN9013P</p>												
40 mA	<p>P14 GPA 200 MHz MP56560 P BFY 50 MC</p>												
30 mA	<p>P13 GPA/SW 350 MHz 2N4400 P</p> <p>P20 GPA/SW 350 MHz 2N2219A/22A MC</p> <p>P19 GPA/SW 350 MHz 2N4401 P</p>												
20 mA	<p>P38 GPA-AUDIO DRIVER 200 MHz NSDU06 DW</p>												
15 mA	<p>P12 GPA 130 MHz 2N3019 MC 2N3700 MC</p> <p>P15 HIGH VOLTAGE VIDEO 170 MHz BF257/8/9 MC</p> <p>P08 GPA-HIGH VOLTAGE DRIVER 200 MHz 2N3501 MC</p>												
10 mA	<p>P27 RF-GPA 500 MHz 2N915 MC MP5A20 P</p> <p>P46 RF-IF 450 MHz PE5025 P</p> <p>P49 RF-GPA 600 MHz MP5H20</p> <p>P47 RF-IF 1000 MHz PE3008 P MP5H24 P</p> <p>P42 RF-VHF/UHF 1000 MHz 2N5179 MC MP5H10 P</p> <p>P44 RF-AGC 550 MHz SE5020 MC MP56560 P</p> <p>P41 RF-AGC 700 MHz BF180/BF200 MP5H08</p>												
8 mA	<p>P43 RF-AMP 900 MHz 2N918 MC MP53563 P 2N5770 P</p> <p>P23 GPA/S 500 MHz 2N3903/4 P</p> <p>P04 LOW LEVEL/LOW NOISE AMP 350 MHz BC107 MC</p> <p>P07 LOW LEVEL/LOW NOISE AMP 140 MHz 2N5088 P 2N930 MC</p>												
6 mA	<p>P16 GPA-HIGH VOLTAGE DRIVER 220 MHz 2N5551 P</p>												
2 mA	<p>P38 GPA-HIGH VOLTAGE DRIVER NSDU07 DW</p> <p>P48 HIGH VOLTAGE VIDEO DRIVER 80 MHz SE7056 MC SP7056 DW</p> <p>P48 HIGH VOLTAGE VIDEO DRIVER 70 MHz SE7057 MC</p>												

P - Plastic (TO-92)  
 MC - Metal Can  
 DW - Durawatt

COLLECTOR BREAKDOWN VOLTAGE  
 BVCEO

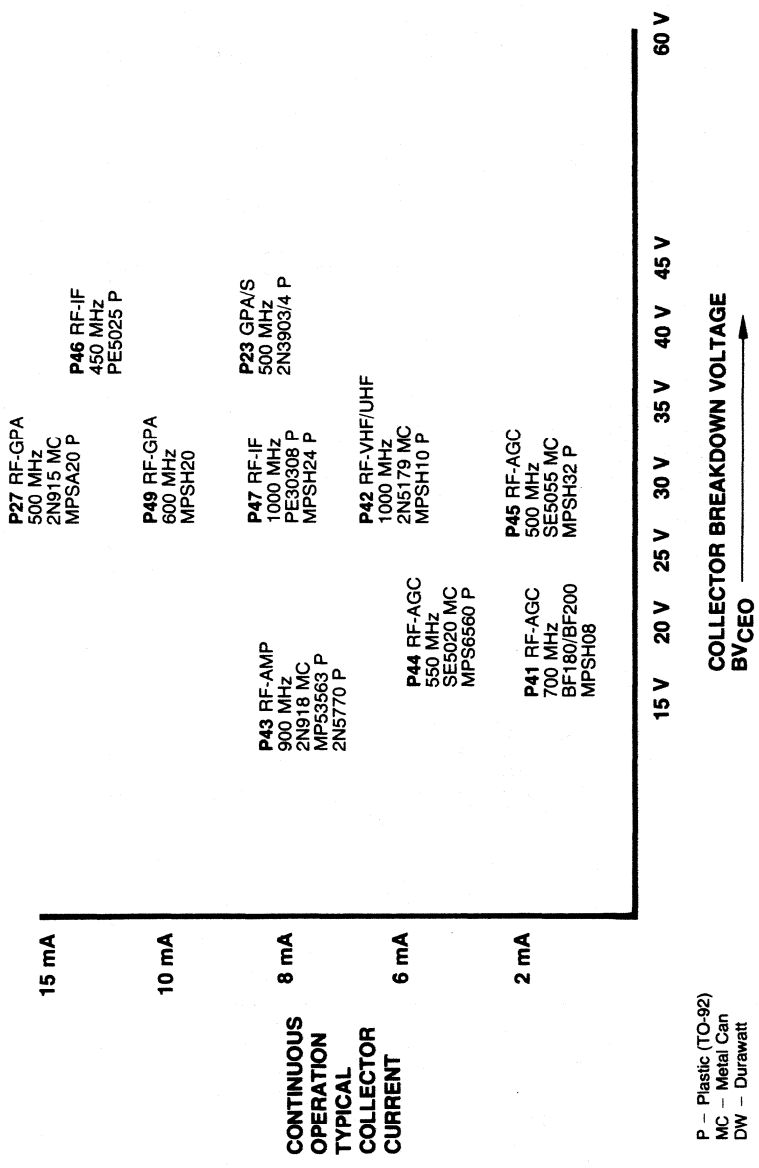

P - Plastic (TO-92)  
 MC - Metal Can  
 DW - Durawatt

# Transistors PNP GPA Devices

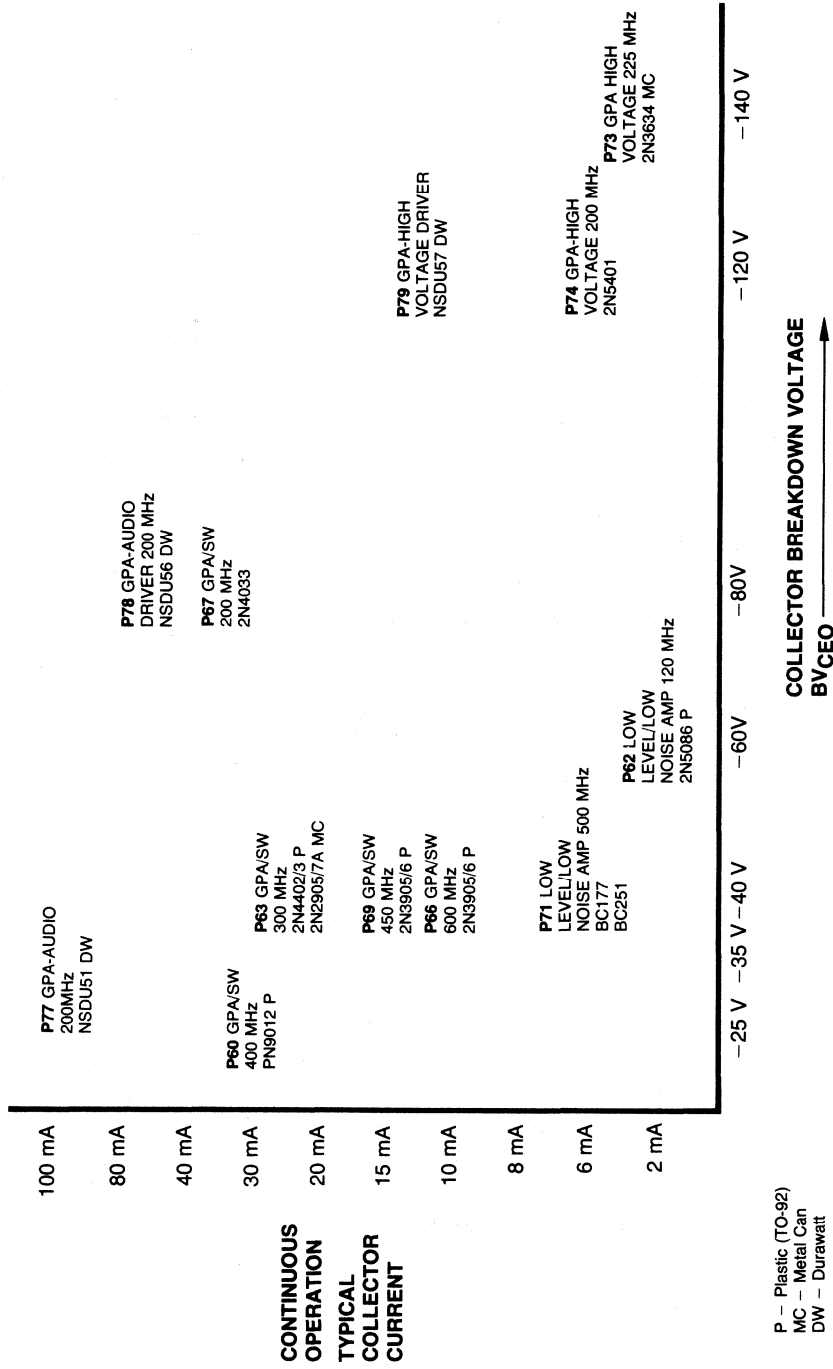

P - Plastic (TO-92)  
 MC - Metal Can  
 DW - Durawatt

	1500 mA	1000 mA	750 mA	500 mA	300 mA	200 mA	150 mA	20 ns	25 ns	30 ns	40 ns	60 ns	200 ns	300 ns	500 ns
<b>MAXIMUM SURVIVABLE COLLECTOR CURRENT</b>															
<b>SATURATED MODE</b>															

GPA/SW - General Purpose Amplifier/Switch  
 HSS - High Speed Switch  
 P - Plastic (TO-92)  
 MC - Metal Can

**MAXIMUM T<sub>OFF</sub>**

**SEE DATA BOOK FOR CIRCUIT CONDITIONS**

# Power Transistor Selector Guide

Ic →	HIGH VOLTAGE AND GENERAL PURPOSE					DARLINGTON			SWITCH MODE			
	Planar	Epi Base Mesa			Planar	Mesa	Mesa		Triple Epi Mesa			
400												
300										400		
200			P-36									
140												
100												
80			P-39/ P-79	P-2C/ P-3C	P-4A/ P-5A	P-4B/ P-5B	P-4C/ P-5C	P-4G/ P-5G				
60			P-38/ P-78	P-2A					P-2J/ P-3J		P-8A P-8B P-8C	
40			P-37/ P-77									
									P-05			
Ic →	0.1A	0.8A	2A	3A	5A	7A	10A	15A	20A	Ic →	10A	15A
Package												
TO-92	0.6W		0.6W									
TO-92+	1.2W	1.2W	1.2W									
TO-202	10W	15W	10W	15W	15W							
TO-126		25W	20W	30W	40W							
TO-220				40W	50W						60W	125W
TO-3						115W	150W	175W	200W			175W

Quote on Request



Power Transistor Part Number Listing

2N3095	TO-3	2N3095	TO-3	92+	D45H2	TO-220	NSDU10	TO-202	NSP567	TO-220	TIP30	TO-220
2N3713	TO-3	2N6881	TO-3	92+	D45H4	TO-220	NSDU45	TO-202	NSP568	TO-220	TIP30A	TO-220
2N3714	TO-3	92PEA68	TO-3	92+	D45H5	TO-220	NSDU45A	TO-202	NSP569	TO-220	TIP30B	TO-220
2N3716	TO-3	92PEA68	TO-3	92+	D45H7	TO-220	NSDU51	TO-202	NSP570	TO-220	TIP30C	TO-220
2N3716	TO-3	92PEA68	TO-3	92+	D45H8	TO-220	NSDU51A	TO-202	NSP571	TO-220	TIP31	TO-220
2N3769	TO-3	92PUB5	TO-3	92+	D45H10	TO-220	NSDU62	TO-202	NSP592	TO-220	TIP31A	TO-220
2N3791	TO-3	92PUB5	TO-3	92+	D45H11	TO-220	NSDU65	TO-202	NSP595	TO-220	TIP31B	TO-220
2N3792	TO-3	92PUB5	TO-3	92+	D45H12	TO-220	NSDU66	TO-202	NSP596	TO-220	TIP31C	TO-220
2N3902	TO-3	92PUB5	TO-3	92+	D45H13	TO-220	NSDU57	TO-202	NSP597	TO-220	TIP32	TO-220
2N3903	TO-3	92PUB5	TO-3	92+	D45H14	TO-220	NSD36	TO-202	NSP598	TO-220	TIP32A	TO-220
2N3904	TO-3	92PUB5	TO-3	92+	D45H15	TO-220	NSD38A	TO-202	NSP599	TO-220	TIP32B	TO-220
2N3905	TO-3	92PUB5	TO-3	92+	D45H16	TO-220	NSD38B	TO-202	NSP600	TO-220	TIP32C	TO-220
2N4905	TO-3	92PUB5A	TO-3	92+	D45H17	TO-220	NSD38C	TO-202	NSP601	TO-220	TIP41	TO-220
2N4906	TO-3	92PUB5A	TO-3	92+	D45H18	TO-220	NSD38D	TO-202	NSP602	TO-220	TIP41A	TO-220
2N4907	TO-3	92PUB5A	TO-3	92+	D45H19	TO-220	NSD102	TO-202	NSP603	TO-220	TIP41B	TO-220
2N4907	TO-3	92PUB5A	TO-3	92+	D45H20	TO-220	NSD103	TO-202	NSP604	TO-220	TIP41C	TO-220
2N4908	TO-3	92PUB5A	TO-3	92+	D45H21	TO-220	NSD104	TO-202	NSP605	TO-220	TIP41D	TO-220
2N4909	TO-3	92PUB5A	TO-3	92+	D45H22	TO-220	NSD105	TO-202	NSP606	TO-220	TIP41E	TO-220
2N4913	TO-3	92PUB5A	TO-3	92+	D45H23	TO-220	NSD106	TO-202	NSP607	TO-220	TIP42	TO-220
2N4914	TO-3	92PUB5A	TO-3	92+	D45H24	TO-220	NSD127	TO-202	NSP608	TO-220	TIP42A	TO-220
2N4815	TO-16	8D344	TO-16	92+	D45H25	TO-220	NSD128	TO-202	NSP609	TO-220	TIP42C	TO-220
2N4816	TO-16	8D345	TO-16	92+	D45H26	TO-220	NSD129	TO-202	NSP610	TO-220	TIP61	TO-220
2N4919	TO-16	8D346	TO-16	92+	D45H27	TO-220	NSD131	TO-202	NSP611	TO-220	TIP61A	TO-220
2N4920	TO-16	8D347	TO-16	92+	D45H28	TO-220	NSD132	TO-202	NSP612	TO-220	TIP61B	TO-220
2N4921	TO-16	8D348	TO-16	92+	D45H29	TO-220	NSD133	TO-202	NSP613	TO-220	TIP61C	TO-220
2N4922	TO-16	8D349	TO-16	92+	D45H30	TO-220	NSD134	TO-202	NSP614	TO-220	TIP62	TO-220
2N4923	TO-16	8D350	TO-16	92+	D45H31	TO-220	NSD135	TO-202	NSP615	TO-220	TIP62A	TO-220
2N5067	TO-3	8D351	TO-3	92+	D45H32	TO-220	NSD151	TO-202	NSP616	TO-220	TIP62B	TO-220
2N5068	TO-3	8D352	TO-3	92+	D45H33	TO-220	NSD152	TO-202	NSP617	TO-220	TIP62C	TO-220
2N5069	TO-3	8D353	TO-3	92+	D45H34	TO-220	NSD153	TO-202	NSP618	TO-220	TIP110	TO-220
2N5190	TO-126	2N6226	TO-3	92+	D45H35	TO-220	NSD154	TO-202	NSP619	TO-220	TIP111	TO-220
2N5191	TO-126	2N6227	TO-3	92+	D45H36	TO-220	NSD164	TO-202	NSP620	TO-220	TIP112	TO-220
2N5192	TO-126	2N6227	TO-3	92+	D45H37	TO-220	NSD202	TO-202	NSP621	TO-220	TIP113	TO-220
2N5194	TO-126	2N6228	TO-3	92+	D45H38	TO-220	NSD203	TO-202	NSP622	TO-220	TIP114	TO-220
2N5194	TO-126	2N6229	TO-3	92+	D45H39	TO-220	NSD204	TO-202	NSP623	TO-220	TIP115	TO-220
2N5195	TO-126	2N6229	TO-3	92+	D45H40	TO-220	NSD205	TO-202	NSP624	TO-220	TIP116	TO-220
2N5198	TO-126	2N6230	TO-3	92+	D45H41	TO-220	NSD206	TO-202	NSP625	TO-220	TIP117	TO-220
2N5293	TO-220	2N6231	TO-3	92+	D45H42	TO-220	NSD207	TO-202	NSP626	TO-220	TIP120	TO-220
2N5294	TO-220	2N6232	TO-3	92+	D45H43	TO-220	NSD208	TO-202	NSP627	TO-220	TIP121	TO-220
2N5295	TO-220	2N6233	TO-3	92+	D45H44	TO-220	NSD209	TO-202	NSP628	TO-220	TIP122	TO-220
2N5296	TO-220	2N6234	TO-3	92+	D45H45	TO-220	NSD457	TO-202	NSP2480	TO-220	TIP125	TO-220
2N5297	TO-220	2N6235	TO-3	92+	D45H46	TO-220	NSD458	TO-202	NSP2481	TO-220	TIP126	TO-220
2N5298	TO-220	2N6236	TO-3	92+	D45H47	TO-220	NSD459	TO-202	NSP2482	TO-220	TIP127	TO-220
2N5490	TO-220	2N6486	TO-220	92+	D45H48	TO-220	NSF467	TO-202	NSP2483	TO-220	TIP130	TO-220
2N5492	TO-220	2N6487	TO-220	92+	D45H49	TO-220	NSF468	TO-202	NSP2484	TO-220	TIP131	TO-220
2N5494	TO-220	2N6488	TO-220	92+	D45H50	TO-220	NSF469	TO-202	NSP2485	TO-220	TIP132	TO-220
2N5496	TO-220	2N6489	TO-220	92+	D45H51	TO-220	NSF41	TO-202	NSP2486	TO-220	TIP133	TO-220
2N5532	TO-3	2N6541	TO-220	92+	D45H52	TO-220	NSF41B	TO-220	NSP2487	TO-220	TIP135	TO-220
2N5533	TO-3	2N6542	TO-220	92+	D45H53	TO-220	NSF41C	TO-220	NSP2488	TO-220	TIP136	TO-220
2N5634	TO-3	2N6549	TO-220	92+	D45H54	TO-220	NSF41D	TO-220	NSP2489	TO-220	TIP137	TO-220
2N5655	TO-126	2N6551	TO-220	92+	D45H55	TO-220	NSF42A	TO-220	NSP5975	TO-220	TN218A	92+
2N5656	TO-126	2N6552	TO-220	92+	D45H56	TO-220	NSF42B	TO-220	NSP5976	TO-220	TN219	92+
2N5657	TO-126	2N6553	TO-220	92+	D45H57	TO-220	NSF42C	TO-220	NSP5977	TO-220	TN219A	92+
2N5758	TO-3	2N6554	TO-220	92+	D45H58	TO-220	NSF42D	TO-220	NSP5978	TO-220	TN2900A	92+
2N5760	TO-3	2N6555	TO-220	92+	D45H59	TO-220	NSP105	TO-220	NSP5979	TO-220	TN2905A	92+
2N5762	TO-3	2N6556	TO-220	92+	D45C1	TO-220	NSP205	TO-220	SE3300	TO-220	TN3019	92+
2N5872	TO-3	2N6557	TO-220	92+	D45C2	TO-220	NSP206	TO-220	SE3301	TO-220	TN3020	92+
2N5873	TO-3	2N6558	TO-220	92+	D45C3	TO-220	NSP207	TO-220	SE3302	TO-220	TN3021	92+
2N5874	TO-3	2N6559	TO-220	92+	D45C4	TO-220	NSP208	TO-220	SE3303	TO-220	TN3022	92+
2N5875	TO-3	2N6560	TO-220	92+	D45C5	TO-220	NSP209	TO-220	SE3304	TO-220	TN3023	92+
2N5876	TO-3	2N6561	TO-220	92+	D45C6	TO-220	NSP210	TO-220	SE3305	TO-220	TN3024	92+
2N5877	TO-3	2N6562	TO-220	92+	D45C7	TO-220	NSP211	TO-220	SE3306	TO-220	TN3025	92+
2N5877	TO-3	2N6563	TO-220	92+	D45C8	TO-220	NSP212	TO-220	SE3307	TO-220	TN4033	92+
2N5878	TO-3	2N6564	TO-220	92+	D45C9	TO-220	NSP213	TO-220	SE3308	TO-220	TN4036	92+
2N5879	TO-3	2N6565	TO-220	92+	D45D1	TO-220	NSP214	TO-220	SE3309	TO-220	TN4037	92+
2N5879	TO-3	2N6566	TO-220	92+	D45D2	TO-220	NSP215	TO-220	SE3310	TO-220	TN4037	92+
2N5879	TO-3	2N6567	TO-220	92+	D45D3	TO-220	NSP216	TO-220	SE3311	TO-220	TN4037	92+
					D45D4	TO-220	NSP217	TO-220	SE3312	TO-220	TN4037	92+
					D45D5	TO-220	NSP218	TO-220	SE3313	TO-220	TN4037	92+
					D45D6	TO-220	NSP219	TO-220	SE3314	TO-220	TN4037	92+
					D45D7	TO-220	NSP220	TO-220	SE3315	TO-220	TN4037	92+
					D45D8	TO-220	NSP221	TO-220	SE3316	TO-220	TN4037	92+
					D45D9	TO-220	NSP222	TO-220	SE3317	TO-220	TN4037	92+
					D45D10	TO-220	NSP223	TO-220	SE3318	TO-220	TN4037	92+
					D45D11	TO-220	NSP224	TO-220	SE3319	TO-220	TN4037	92+
					D45D12	TO-220	NSP225	TO-220	SE3320	TO-220	TN4037	92+
					D45D13	TO-220	NSP226	TO-220	SE3321	TO-220	TN4037	92+
					D45D14	TO-220	NSP227	TO-220	SE3322	TO-220	TN4037	92+
					D45D15	TO-220	NSP228	TO-220	SE3323	TO-220	TN4037	92+
					D45D16	TO-220	NSP229	TO-220	SE3324	TO-220	TN4037	92+
					D45D17	TO-220	NSP230	TO-220	SE3325	TO-220	TN4037	92+
					D45D18	TO-220	NSP231	TO-220	SE3326	TO-220	TN4037	92+
					D45D19	TO-220	NSP232	TO-220	SE3327	TO-220	TN4037	92+
					D45D20	TO-220	NSP233	TO-220	SE3328	TO-220	TN4037	92+
					D45D21	TO-220	NSP234	TO-220	SE3329	TO-220	TN4037	92+
					D45D22	TO-220	NSP235	TO-220	SE3330	TO-220	TN4037	92+
					D45D23	TO-220	NSP236	TO-220	SE3331	TO-220	TN4037	92+
					D45D24	TO-220	NSP237	TO-220	SE3332	TO-220	TN4037	92+
					D45D25	TO-220	NSP238	TO-220	SE3333	TO-220	TN4037	92+
					D45D26	TO-220	NSP239	TO-220	SE3334	TO-220	TN4037	92+
					D45D27	TO-220	NSP240	TO-220	SE3335	TO-220	TN4037	92+
					D45D28	TO-220	NSP241	TO-220	SE3336	TO-220	TN4037	92+
					D45D29	TO-220	NSP242	TO-220	SE3337	TO-220	TN4037	92+
					D45D30	TO-220	NSP243	TO-220	SE3338	TO-220	TN4037	92+
					D45D31	TO-220	NSP244	TO-220	SE3339	TO-220	TN4037	92+
					D45D32	TO-220	NSP245	TO-220	SE3340	TO-220	TN4037	92+
					D45D33	TO-220	NSP246	TO-220	SE3341	TO-220	TN4037	92+
					D45D34	TO-220	NSP247	TO-220	SE3342	TO-220	TN4037	92+
					D45D35	TO-220	NSP248	TO-220	SE3343	TO-220	TN4037	92+
					D45D36	TO-220	NSP249	TO-220	SE3344	TO-220	TN4037	92+
					D45D37	TO-220	NSP250	TO-220	SE3345	TO-220	TN4037	92+
					D45D38	TO-220	NSP251	TO-220	SE3346	TO-220	TN4037	92+
					D45D39	TO-220	NSP252	TO-220				

# 92+ Power Transistor Reference Guide

PART NUMBER		V <sub>CEO</sub> (V)	I <sub>C</sub> (A)	hFE		I <sub>C</sub> (mA) @		V <sub>CE</sub> (V)	MAX V <sub>CE</sub> (SAT) (V) @ I <sub>C</sub> (mA)	P <sub>D</sub> (W)	f <sub>T</sub> (MHz)	PROCESS (NPN/PNP)
NPN	PNP			MIN	MAX	I <sub>C</sub> (mA)	V <sub>CE</sub> (V)					
TN2219		30	0.5	100	300	150	10	0.4	1.2	250	19	
TN3724		30	1	30	150	500	10	0.2	1.2	300	25	
92PU01	92PU51	30	2	40	300	300	1	0.32	1.2	50	37/77	
				60		100	1	0.5				
				55		1000	1					
TN2218A		40	0.5	40	120	150	10	0.3	1.2	250	19	
TN2219A	TN2905	40	0.5	25	300	500	10	0.3/0.4	1.2	300	19/63	
TN3053	TN4037	40	1	40	250	500	10	1.4	1.2	100	12/63	
92PU01A	92PU51A	40	2	50	300	1000	1	0.5	1.2	50	37/77	
				55		1000	1					
92PU45		40	2	25k		200	5	1	1.2	100	05	
				4k		1000	5	1.5				
92PE37A	92PE77A	45	2	40		500	2	0.5	1.2	50	38/78	
TN3725		50	1	60	150	100	1	0.4	1.2	300	25	
92PU45A		50	2	40	300	300	5	1	1.2	100	05	
				25k		200	5	1.5				
				4k		1000	5					
	TN2904A	60	0.5	40	120	150	10	0.4	1.2	200	63	
				40		500	10					
	TN2905A	60	0.5	100	300	150	10	0.4	1.2	200	63	
92PE37B	92PE77B	60	2	50		500	10					
92PU05	92PU55	60	2	40		500	2	0.5	1.2	50	38/78	
				20		500	1	0.35	1.2	50	39/79	
TN2102	TN4036	65	1	40	120	150	10	0.5/0.65	1.2	60	12/67	
				25		500	10					
TN3019		80	1	100	300	150	10	0.2	1.2	100	12	
TN3020		80	1	40	120	150	10	0.2	1.2	100	12	
	TN4033	80	1	100	300	100	5	0.15	1.2	150	67	
92PE37C	92PE77C	80	2	40		500	2	0.5	1.2	50	38/78	
92PU06	92PU56	80	2	20		500	1	0.35	1.2	50	39/79	
				20		500	1	0.35				
92PU07	92PU57	100	2	20		500	1	0.35	1.2	50	39/79	
92PE487		160	0.1	30		30	10	1	1.2	50	48	
92PU391		200	0.1	40		10	10	2	1.2	50	48	
92PE488		250	0.1	30		30	10	1	1.2	50	48	
92PU392		250	0.1	40		10	10	2	1.2	50	48	
92PE489		300	0.1	30		30	10	1	1.2	50	48	
92PU393		300	0.1	40		10	10	2	1.2	50	48	
92PU10		300	0.1	40		30	10	0.75	1.2	50	48	

# TO-202 Power Transistor Reference Guide

PART NUMBER		PROCESS (NPN/PNP)		IC (A)		V <sub>CEO</sub> (V)	hFE		MAX VCE(SAT) (V) @ IC (A)		PD (W)	f <sub>T</sub> (MHz)	PROCESS (NPN/PNP)
NPN	PNP	hFE		VCE (V)		MIN	MAX	IC (A)	VCE (V)	MAX	IC (A)	f <sub>T</sub> (MHz)	PROCESS (NPN/PNP)
		MIN	MAX	MIN	MAX								
NSD457		0.1	160	0.1	0.03	10	1	0.03	1.75	1.3	75	38/78	
NSE457		0.1	160	0.1	0.03	10	1	0.03	1.75	1.3	75	39/79	
NSD458		0.1	250	0.03	10	1	0.03	1.75	50	1.75	60	39/79	
NSE458		0.1	250	0.03	10	1	0.03	1.75	50	1.75	60	39/79	
D40N1		0.1	250	30	90	0.02	10	1.3	50	1.75	60	39/79	
D40N2		0.1	250	30	90	0.02	10	1.3	50	1.75	60	39/79	
NSD131		0.1	250	30	90	0.03	10	0.02	1.75	1.75	10	36	
NSD132		0.1	250	60	180	0.03	10	0.02	1.75	1.75	10	36	
D40N3		0.1	300	30	90	0.02	10	1.3	50	1.75	10	36	
D40N4		0.1	300	60	180	0.02	10	1.3	50	1.75	10	36	
NSD133		0.1	300	30	90	0.03	10	0.02	1.75	1.75	50	37/77	
NSD134		0.1	300	60	180	0.03	10	0.02	1.75	1.75	50	37/77	
NSE459		0.1	300	25	75	0.03	10	0.03	1.75	1.75	100	05	
NSD100		0.1	300	40	120	0.03	10	1.5	0.02	1.75	1.75	50	38/78
D40N5		0.1	375	20	60	0.02	10	0.03	1.75	1.75	50	37/77	
NSD135		0.1	375	30	90	0.03	10	0.02	1.75	1.75	50	37/77	
D40C1		0.5	30	10k	60k	0.2	5	1.5	0.5	1.3	100	05	
D40C2		0.5	30	40k	120k	0.2	5	1.5	0.5	1.3	100	05	
D40C3		0.5	30	90k	270k	0.2	5	1.5	0.5	1.3	100	05	
D40C4		0.5	40	10k	60k	0.2	5	1.5	0.5	1.3	100	05	
D40C5		0.5	40	40k	120k	0.2	5	1.5	0.5	1.3	100	05	
D40C6		0.5	50	10k	60k	0.2	5	1.5	0.5	1.3	100	05	
D40C8		0.5	50	40k	120k	0.2	5	1.5	0.5	1.3	100	05	
D40P1		0.5	120	40	120	0.08	10	0.1	1.3	1.3	50	39/78	
D40P3		0.5	180	40	120	0.08	10	0.1	1.3	1.3	50	39/78	
D40P5		0.5	225	40	120	0.08	10	0.1	1.3	1.3	50	39/78	
D40D1	D41D1	1	30	50	150	0.1	2	0.5	0.5	1.3	40	08	
D40D2	D41D2	1	30	120	300	0.1	2	0.5	0.5	1.3	25	37/77	
D40D3		1	30	290	300	0.1	2	0.5	0.5	1.3	40	38/78	
D40D4	D41D4	1	45	50	150	0.1	2	0.5	0.5	1.3	40	38/78	
D40D5	D41D5	1	45	120	360	0.1	2	0.5	0.5	1.3	25	37/77	
D40D6		1	45	50	150	0.1	5	0.2	1	1.75	40	37/77	
NSD102	NSD202	1	45	50	150	0.1	5	0.2	1	1.75	40	37/77	
NSD103	NSD203	1	45	120	360	0.1	5	0.2	1	1.75	40	37/77	
D40D7	D41D7	1	60	50	150	0.1	2	0.5	1.3	1.3	50	38/78	
D40D8	D41D8	1	60	120	360	0.1	2	0.5	1.3	1.3	50	38/78	
2N6551	2N6554	1	60	80	250	0.05	1	0.5	0.25	1.75	25	38/78	
D40D10	D41D10	1	75	50	150	0.1	2	1	0.5	1.3	40	38/78	
D40D11	D41D11	1	75	120	360	0.1	2	1	0.5	1.3	40	38/78	
D40D13	D41D13	1	75	50	150	0.1	2	1	0.5	1.3	40	38/78	

Note: Preferred part types are shaded.

# TO-126 Power Transistor Reference Guide

PART NUMBER		IC (A)	V <sub>CEO</sub> (V)	h <sub>FE</sub>		I <sub>C</sub> (A) @		V <sub>CE</sub> (V)	MAX V <sub>CE</sub> (SAT) (V) @ I <sub>C</sub> (A)	P <sub>D</sub> (W)	f <sub>T</sub> (MHz)	PROCESS (NPN/PNP)
NPN	PNP			MIN	MAX	I <sub>C</sub> (A)	I <sub>C</sub> (A)					
MJE3440		0.3	250	40	160	0.02	0.02	10	0.5	15	15	36
MJE3439		0.3	350	40	160	0.02	0.02	10	0.5	15	15	36
MJE341		0.5	150	25	200	0.05	0.05	10	1	20	15	36
MJE344		0.5	200	30	300	0.05	0.05	10	1	30	15	36
2N5655		0.5	250	30	250	0.1	0.1	10	1	20	10	36
MJE340		0.5	300	30	240	0.05	0.05	10	1	20	10	36
2N5656		0.5	300	30	250	0.1	0.1	10	1	20	10	36
2N5657		0.5	350	30	250	0.1	0.1	10	1	20	10	36
MJE520	MJE370	1	30	25		1	1	1		25		2C/3C
2N4921	2N4918	1	40	20	100	0.5	0.5	1	0.6	30	3	2C/3C
2N4922	2N4919	1	60	20	100	0.5	0.5	1	0.6	30	3	2C/3C
2N4923	2N4920	1	80	20	100	0.5	0.5	1	0.6	30	3	2C/3C
MJE720	MJE710	1.5	40	40		0.15	0.15	1	0.15	20		37/77
BD345	BD344	1.5	60	40	250	0.2	0.2	1	0.4	20	50	38/78
MJE721	MJE711	1.5	60	40		0.15	0.15	1	0.15	20		38/78
BD349	BD348	1.5	80	50	250	0.25	0.25	1	0.5	20	50	39/79
MJE722	MJE712	1.5	80	40		0.15	0.15	1	0.15	20		39/79
MJE180	MJE170	3	40	50	250	0.1	0.1	1	0.3	12.5	50	37/77
MJE181	MJE171	3	60	50	250	0.1	0.1	1	0.3	12.5	50	38/78
MJE182	MJE172	3	80	50	250	0.1	0.1	1	0.3	12.5	50	39/79
MJE521	MJE371	4	40	40		0.1	0.1	1		40		2C/3C
2N5190	2N5193	4	40	25	100	1.5	1.5	2	0.6	40	2	2E/3E
2N6037	2N6034	4	40	750	15k	2	2	3	2	40		2J/3J
2N5191	2N5194	4	60	25	100	1.5	1.5	2	0.6	40	2	2E/3E
MJE800	MJE700	4	60	750		1.5	1.5	3	2.5	40		2J/3J
MJE801	MJE701	4	60	750		2	2	3	2.8	40		2J/3J
2N6038	2N6035	4	60	750	15k	2	2	3	2	40		2J/3J
MJE802	MJE702	4	80	750		1.5	1.5	3	2.5	40		2J/3J
MJE803	MJE703	4	80	750		2	2	3	2.8	40		2J/3J
2N5192	2N5195	4	80	20	80	1.5	1.5	2	0.6	40	2	2E/3E
2N6039	2N6036	4	80	750	15k	2	2	3	2	40		2J/3J

# TO-220 Power Transistor Reference Guide

PART NUMBER	PART NUMBER	I <sub>C</sub> (A)	V <sub>CEO</sub> (V)	h <sub>FE</sub>		I <sub>C</sub> (A)	V <sub>CE(SAT)</sub> (V)@I <sub>C</sub> (A)	P <sub>D</sub> (W)	f <sub>T</sub> (MHz)	PROCESS (NPN/PNP)	PART NUMBER	PART NUMBER	I <sub>C</sub> (A)	V <sub>CEO</sub> (V)	h <sub>FE</sub>		I <sub>C</sub> (A)	V <sub>CE(SAT)</sub> (V)@I <sub>C</sub> (A)	P <sub>D</sub> (W)	f <sub>T</sub> (MHz)	PROCESS (NPN/PNP)		
				MIN	MAX										MIN	MAX							
TIP62	NSP42B	5	80	15	75	3	4	1.5	50	4E/5E	NSP41B	NSP42B	5	80	15	75	3	4	1.5	50	4E/5E		
TIP61A	NSP6875	5	80	20	120	2.5	2	0.8	75	4E/5E	NSP6875	NSP6875	5	80	20	120	2.5	2	0.8	75	4E/5E		
TIP62A	NSP2092	5	80	750	4	3	2.5	3	70	4E/5E	NSP2102	NSP2092	5	80	750	4	3	2.5	70	4E/5E			
TIP61B	NSP2093	5	80	750	4	3	2.5	3	70	4E/5E	NSP2103	NSP2093	5	80	750	4	3	2.5	70	4E/5E			
TIP62C	TIP478	5	80	75	3	3	3	3	70	4E/5E	TIP478	TIP478	5	80	75	3	3	3	70	4E/5E			
TIP30A	NSP42C	5	100	15	75	3	4	1.5	50	4E/5E	NSP41C	NSP42C	5	100	15	75	3	4	1.5	50	4E/5E		
TIP30A	TIP427	5	100	1000	3	3	3	3	50	4E/5E	TIP427	TIP427	5	100	1000	3	3	3	50	4E/5E			
TIP30B	TIP42A	5	60	15	75	3	4	1.5	65	4E/5E	TIP42A	TIP42A	5	60	15	75	3	4	1.5	65	4E/5E		
TIP30C	TIP42B	5	60	15	75	3	4	1.5	65	4E/5E	TIP42B	TIP42B	5	60	15	75	3	4	1.5	65	4E/5E		
TIP110	TIP135	5	80	1000	15	75	4	2	65	4E/5E	TIP135	TIP135	5	80	1000	15	75	4	2	65	4E/5E		
TIP115	TIP136	5	80	15	75	3	4	1.6	65	4E/5E	TIP136	TIP136	5	80	15	75	3	4	1.6	65	4E/5E		
TIP117	TIP43B	5	80	15	75	3	4	1.6	65	4E/5E	TIP43B	TIP43B	5	80	15	75	3	4	1.6	65	4E/5E		
TIP112	NSP2470	3	40	200	100	15	4	0.6	2	5E	TIP131	TIP136	6	100	1000	15	4	2	4	2	4	4E/5E	
NSP2520	NSP2370	3	40	200	100	15	4	0.7	1	4E/5E	TIP41C	TIP42C	6	100	1000	15	4	2	4	2	4	4E/5E	
TIP31	TIP32	3	40	10	50	3	4	1.2	3	4E/5E	TIP132	TIP137	6	100	1000	15	4	2	4	2	4	4E/5E	
NSP575	NSP576	3	45	25	100	1	1	0.6	1	4E/5E	TIP268	TIP611	7	30	30	15	3	4	1	3	40	4E/5E	
NSP577	NSP578	3	60	25	100	1	1	0.6	1	4E/5E	NSP5490	NSP5494	7	40	20	100	2	4	1	0.2	50	0.8	4E
NSP2491	NSP2491	3	60	20	100	1	1	0.6	1	4E/5E	NSP5494	NSP5494	7	40	20	100	2	4	1	0.2	50	0.8	4E
TIP31A	TIP32A	3	60	10	50	3	4	1.2	3	4E/5E	NSP6129	NSP6132	7	40	20	100	2.5	4	1.4	7	50	2.5	4E/5E
NSP579	NSP580	3	60	15	1	1	1	0.8	1	4E/5E	NSP6132	NSP6132	7	40	20	100	2.5	4	1.4	7	50	2.5	4E/5E
TIP31B	TIP32B	3	60	15	1	1	1	0.8	1	4E/5E	NSP6132	NSP6132	7	40	20	100	2.5	4	1.4	7	50	2.5	4E/5E
TIP31C	TIP32C	3	60	15	1	1	1	0.8	1	4E/5E	NSP6132	NSP6132	7	40	20	100	2.5	4	1.4	7	50	2.5	4E/5E
NSP581	NSP582	3	100	15	1	1	1	0.8	1	4E/5E	NSP6132	NSP6132	7	40	20	100	2.5	4	1.4	7	50	2.5	4E/5E
TIP31C	TIP32C	3	100	15	1	1	1	0.8	1	4E/5E	NSP6132	NSP6132	7	40	20	100	2.5	4	1.4	7	50	2.5	4E/5E
D44C1	D44C2	3	30	35	50	3	4	0.2	3	4E/5E	NSP692	NSP692	7	70	30	150	2	4	1	0.35	50	0.8	4E
D44C2	D44C3	4	30	40	120	0.2	1	0.5	1	4E/5E	NSP692	NSP692	7	70	30	150	2	4	1	0.35	50	0.8	4E
D44C3	D44C3	4	30	40	120	0.2	1	0.5	1	4E/5E	NSP692	NSP692	7	70	30	150	2	4	1	0.35	50	0.8	4E
NSP2480	NSP2482	4	40	20	100	1.5	4	0.7	1.5	4A	NSP583	NSP580	8	40	20	120	4	2	6.6	4	2	4A/5A	
NSP2486	NSP2487	4	40	30	120	1	4	1	1	4E	NSP586	NSP586	8	40	1000	20	3	2	3	2	3	4E/5E	
D44C4	D44C5	4	45	25	40	0.2	1	0.5	1	4E/5E	NSP595	NSP595	8	45	25	3	2	1	3	2	3	4E/5E	
D44C5	D44C5	4	45	25	40	0.2	1	0.5	1	4E/5E	NSP595	NSP595	8	45	25	3	2	1	3	2	3	4E/5E	
D44C6	D44C6	4	45	25	40	0.2	1	0.5	1	4E/5E	NSP695A	NSP695A	8	45	750	40	4	3	2.8	4	2	4E/5E	
NSP585	NSP586	4	45	25	40	0.2	1	0.5	1	4E/5E	NSP695A	NSP695A	8	45	750	40	4	3	2.8	4	2	4E/5E	
NSP2481	NSP2482	4	45	25	100	2	2	0.5	2	4E/5E	NSP697	NSP698	8	60	20	120	4	2	0.6	4	2	4E/5E	
D44C7	D44C7	4	60	25	100	1.5	2	0.5	1.5	4E/5E	NSP697	NSP698	8	60	20	120	4	2	0.6	4	2	4E/5E	
D44C8	D44C8	4	60	25	100	1.5	2	0.5	1.5	4E/5E	NSP697	NSP698	8	60	20	120	4	2	0.6	4	2	4E/5E	
NSP587	NSP588	4	60	25	100	1.5	2	0.5	1.5	4E/5E	NSP697	NSP698	8	60	20	120	4	2	0.6	4	2	4E/5E	
NSP587	NSP588	4	60	25	100	1.5	2	0.5	1.5	4E/5E	NSP697	NSP698	8	60	20	120	4	2	0.6	4	2	4E/5E	
NSP2483	NSP2483	4	60	20	100	2.5	4	0.7	1.5	4A	NSP699	NSP700	8	80	750	40	4	3	2.5	3	2	4E/5E	
NSP2483	NSP2483	4	60	20	100	2.5	4	0.7	1.5	4A	NSP699	NSP700	8	80	750	40	4	3	2.5	3	2	4E/5E	
NSP2483	NSP2483	4	60	20	100	2.5	4	0.7	1.5	4A	NSP699	NSP700	8	80	750	40	4	3	2.5	3	2	4E/5E	
NSP2483	NSP2483	4	60	20	100	2.5	4	0.7	1.5	4A	NSP699	NSP700	8	80	750	40	4	3	2.5	3	2	4E/5E	
NSP2483	NSP2483	4	60	20	100	2.5	4	0.7	1.5	4A	NSP699	NSP700	8	80	750	40	4	3	2.5	3	2	4E/5E	
NSP2483	NSP2483	4	60	20	100	2.5	4	0.7	1.5	4A	NSP699	NSP700	8	80	750	40	4	3	2.5	3	2	4E/5E	
NSP2483	NSP2483	4	60	20	100	2.5	4	0.7	1.5	4A	NSP699	NSP700	8	80	750	40	4	3	2.5	3	2	4E/5E	
NSP2483	NSP2483	4	60	20	100	2.5	4	0.7	1.5	4A	NSP699	NSP700	8	80	750	40	4	3	2.5	3	2	4E/5E	
NSP2483	NSP2483	4	60	20	100	2.5	4	0.7	1.5	4A	NSP699	NSP700	8	80	750	40	4	3	2.5	3	2	4E/5E	
NSP2483	NSP2483	4	60	20	100	2.5	4	0.7	1.5	4A	NSP699	NSP700	8	80	750	40	4	3	2.5	3	2	4E/5E	
NSP2483	NSP2483	4	60	20	100	2.5	4	0.7	1.5	4A	NSP699	NSP700	8	80	750	40	4	3	2.5	3	2	4E/5E	
NSP2483	NSP2483	4	60	20	100	2.5	4	0.7	1.5	4A	NSP699	NSP700	8	80	750	40	4	3	2.5	3	2	4E/5E	
NSP2483	NSP2483	4	60	20	100	2.5	4	0.7	1.5	4A	NSP699	NSP700	8	80	750	40	4	3	2.5	3	2	4E/5E	
NSP2483	NSP2483	4	60	20	100	2.5	4	0.7	1.5	4A	NSP699	NSP700	8	80	750	40	4	3	2.5	3	2	4E/5E	
NSP2483	NSP2483	4	60	20	100	2.5	4	0.7	1.5	4A	NSP699	NSP700	8	80	750	40	4	3	2.5	3	2	4E/5E	
NSP2483	NSP2483	4	60	20	100	2.5	4	0.7	1.5	4A	NSP699	NSP700	8	80	750	40	4	3	2.5	3	2	4E/5E	
NSP2483	NSP2483	4	60	20	100	2.5	4	0.7	1.5	4A	NSP699	NSP700	8	80	750	40	4	3	2.5	3	2	4E/5E	
NSP2483	NSP2483	4	60	20	100	2.5	4	0.7	1.5	4A	NSP699	NSP700	8	80	750	40	4	3	2.5	3	2	4E/5E	
NSP2483	NSP2483	4	60	20	100	2.5	4	0.7	1.5	4A	NSP699	NSP700	8	80	750	40	4	3	2.5	3	2	4E/5E	
NSP2483	NSP2483	4	60	20	100	2.5	4	0.7	1.5	4A	NSP699	NSP700	8	80	750	40	4	3	2.5	3	2	4E/5E	
NSP2483																							

# TO-3 Power Transistor Reference Guide

PART NUMBER		IC (A)	V <sub>CEO</sub> (V)	h <sub>FE</sub>		@		MAX V <sub>CE(SAT)</sub>		P <sub>D</sub> (W)	f <sub>T</sub> (MHz)	PROCESS (NPN/PNP)
NPN	PNP			MIN	MAX	I <sub>C</sub> (A)	V <sub>CE</sub> (V)	(V)	@ I <sub>C</sub> (A)			
2N5067	2N4901	5	40	20	80	1	2	0.4	1	87.5	4	4A/5A
2N4913	2N4904	5	40	25	100	2.5	2	1	2.5	87.5	4	4A/5A
2N5068	2N4902	5	60	20	80	1	2	0.4	1	87.5	4	4A/5A
2N4914	2N4905	5	60	25	100	2.5	2	1	2.5	87.5	4	4A/5A
2N5069	2N4903	5	80	20	80	1	2	0.4	1	87.5	4	4A/5A
2N4915	2N4906	5	80	25	100	2.5	2	1	2.5	87.5	4	4A/5A
2N5758	2N6226	6	100	25	100	3	2	1	3	150	1	4B/5B
2N5759	2N6227	6	120	20	80	3	2	1	3	150	1	4B/5B
2N5760	2N6228	6	140	15	60	3	2	1	3	150	1	4B/5B
2N5873	2N5871	7	60	20	100	2.5	4	1	4	115	4	4A/5A
2N5874	2N5872	7	80	20	100	2.5	4	1	4	115	4	4A/5A
2N6055	2N6053	8	60	750	18,000	4	3	2	4	100	4	4K/5K
MJ1000	MJ900	8	60	1000	18,000	3	3	2	3	90	4	4K/5K
2N6056	2N6054	8	80	750	18,000	4	3	2	4	100	4	4K/5K
MJ1001	MJ901	8	80	1000	18,000	3	3	2	3	90	4	4K/5K
2N4907	2N4907	10	40	20	80	4	4	0.75	4	150	4	5B
2N3713	2N3789	10	60	25	90	1	2	1	5	150	4	4B/5B
2N3715	2N3791	10	60	50	150	1	2	0.8	5	150	4	4B/5B
MJ2840	MJ2940	10	60	20	100	3	2	0.75	4	150	2	4B/5B
2N4908	2N4908	10	60	20	80	4	4	1	5	150	4	5B
2N5877	2N5875	10	60	20	100	4	4	1	5	150	4	4B/5B
2N3714	2N3790	10	80	25	90	1	2	1	5	150	4	4B/5B
2N3716	2N3792	10	80	50	150	1	2	0.8	5	150	4	4B/5B
2N5878	2N5876	10	80	20	80	4	4	0.75	4	150	4	5B
MJ2841	MJ2941	10	80	20	100	4	4	1	5	150	4	4B/5B
2N5632	2N6229	10	100	25	100	5	2	1	7.5	150	2	4B/5B
2N5633	2N6230	10	120	20	80	5	2	1	7.5	150	1	4C/5C
2N5634	2N6231	10	140	15	60	5	2	1	7.5	150	1	4C/5C
2N6569	2N6594	12	40	15	200	4	3	1.5	8	100	4	4A/5A
MJ2801	MJ2901	15	40	15	60	8	4	1.1	4	115	1	4A/5A
2N3055	MJ2955	15	60	20	70	4	4	1	7	160	2.5	4A/5A
2N5881	2N5879	15	60	20	100	6	4	2	6	160	4	4C/5C
BD351	BD350	15	80	20	100	6	2.5	1	6	160	4	4C/5C
2N5882	2N5880	15	80	20	100	6	4	2	7	160	4	4C/5C



Appendices  
**Glossary of Symbols**  
**Package Outlines**



**DC PARAMETERS**

**$BV_{CBO}$**       **Collector-Base Breakdown Voltage with Emitter Open-Circuited**  
 The breakdown voltage of the collector-base junction, measured at a specified current, with the emitter open-circuited.

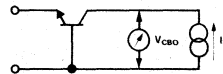

**$BV_{CEO}$**       **Collector-Emitter Breakdown Voltage with the Base Open-Circuited**  
 The collector-emitter breakdown voltage, measured at a specified collector current, with the base open-circuited.

**$BV_{CER}$**       **Collector-Emitter Breakdown Voltage with Resistance between Emitter and Base**  
 The collector-emitter breakdown voltage measured at a specified current with a specified resistance R connected between the base and the emitter.

**$BV_{CES}$**       **Collector-Emitter Breakdown Voltage with Base Shorted to Emitter**  
 The collector-emitter breakdown, measured at a specified current, with the base shorted to the emitter.

**$BV_{CEX}$**       **Collector-Emitter Breakdown Voltage at a Specified Condition**  
 The collector-emitter breakdown voltage measured at a specified current with the base-emitter junction forward or reverse biased by a specified voltage or current.

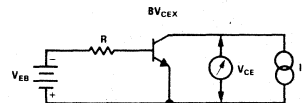
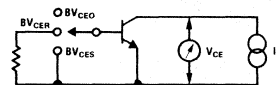
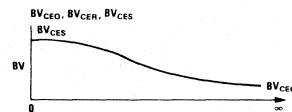

**$BV_{EBO}$**       **Emitter-Base Breakdown Voltage with Collector Open-Circuited**  
 The emitter-base breakdown voltage, measured at a specified current, with the collector open-circuited.

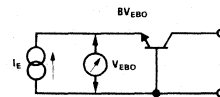

**$h_{FE}$**       **Common-Emitter DC Current Gain**  
 The ratio of DC collector current to DC base current measured at a specified collector-emitter voltage and a specified collector current.

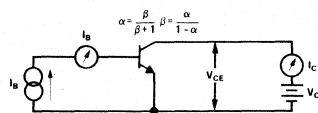
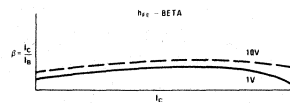



<p><b><math>I_{CBO}</math></b>      <b>Inverse Collector-Base Current</b></p> <p>The collector-base current with the junction reverse biased by a specified voltage, with the emitter open-circuited.</p>	
<p><b><math>I_{CEX}</math></b>      <b>Inverse Collector-Emitter Current at a Specified Condition</b></p> <p>The collector-emitter current measured at a specified collector-emitter voltage with the base forward or reverse biased by a specified voltage or current.</p>	
<p><b><math>I_{EBO}</math></b>      <b>Inverse Emitter-Base Current</b></p> <p>The emitter-base current with the junction reverse biased by a specified voltage with the collector open-circuited.</p>	
<p><b><math>LV_{CEO}</math></b>  <b><math>LV_{CER}</math></b>  <b><math>LV_{CES}</math></b>  <b><math>LV_{CEX}</math></b> or,  <b><math>V_{CEO}(sust)</math></b>  <b><math>V_{CER}(sust)</math></b>  <b><math>V_{CES}(sust)</math></b>  <b><math>V_{CEX}(sust)</math></b></p> <p><b>Pulsed Limiting Breakdown Voltages</b></p> <p>These are similar to the corresponding, above defined, BV parameters but are measured at a specified high current point where collector-emitter voltage is lowest. The duration of the pulse and its duty cycle must be specified. The letter L indicates LIMITING Value and is measured outside the negative resistance zone of the reverse characteristic.</p>	
<p><b><math>V_{BE(ON)}</math></b>      <b>Unsaturated Base-Emitter Voltage</b></p> <p>The base-emitter voltage measured in the common-emitter connection at a specified collector to emitter voltage and specified collector current.</p>	

<p><math>V_{BE(SAT)}</math></p> <p><math>V_{CE(SAT)}</math></p>	<p><b>Base-Emitter Saturation Voltage</b></p> <p>The base-emitter voltage measured in the common-emitter connection at a specified collector and base saturation currents.</p> <p><b>Collector-Emitter Saturation Voltage</b></p> <p>The collector-emitter voltage measured in the common-emitter connection at specified collector and base saturation currents.</p>	<p>The circuit diagram shows a common-emitter transistor with a base current source <math>I_B</math> and a collector current source <math>I_C</math>. The base-emitter voltage is <math>V_{BE(SAT)}</math> and the collector-emitter voltage is <math>V_{CE(SAT)}</math>. The relationship <math>\beta_{CKT} = \frac{I_C}{I_B}</math> is noted.</p> <p>The first graph plots <math>V_{SAT}</math> against FORCED BETA, showing <math>V_{BE}</math> increasing and <math>V_{CE}</math> decreasing as beta increases.</p> <p>The second graph plots <math>V_{CE}</math> against <math>\text{LOG } I_B</math> for three different collector currents <math>I_{C1} &lt; I_{C2} &lt; I_{C3}</math>. The curves show <math>V_{CE}</math> increasing with <math>\text{LOG } I_B</math> until they reach a SATURATION region.</p>
<p><math>V_{RT}</math></p> <p><math>V_{PT}</math></p>	<p><b>Reach Through Voltage</b></p> <p><b>Punch Through Voltage</b></p> <p>The collector-base voltage above which an increase of applied voltage can be measured in the emitter-base open circuit.</p>	
<p><b>SMALL SIGNAL PARAMETERS</b></p>		
<p><math>C_{ob}</math></p>	<p><b>Common-Base Output Capacitance</b></p> <p>The common-base output capacitance with input ac open.</p>	<p>The diagram shows a common-base transistor configuration. The base is connected to ground (B), the emitter is open (E), and the collector is connected to a terminal C. A note says 'MEASURE OUTPUT CAPACITANCE'. The label '1) <math>C_{ob}</math> CAPACITANCE' is present.</p>
<p><math>C_{re}</math></p>	<p><b>Common Emitter Reverse Transfer Capacitance</b></p> <p>This parameter is the imaginary part of <math>y_{re}</math>. When <math>I_C = 0</math>, <math>C_{re}</math> is identical to <math>C_{CB}</math>.</p>	
<p><math>C_{TE}</math></p> <p><math>C_{CB}</math></p>	<p><b>Base-Emitter Capacitance</b></p> <p>The capacity of the base-emitter junction at a specified inverse voltage with the collector open.</p> <p><b>Collector Base Capacitance</b></p> <p>Collector Base Capacitance measured at some Specified Collector Base Voltage.</p>	<p>The diagram shows a common-emitter transistor with a collector terminal C, base terminal B, and emitter terminal E. Capacitors <math>C_{CE}</math>, <math>C_{EB}</math>, and <math>C_{CB}</math> are shown between the terminals.</p> <p>Equations provided:</p> $C_{ob} = C_{CB} + \frac{C_{CE} \cdot C_{EB}}{C_{CE} + C_{EB}} = C_{CB} + C_{CE}$ <p>2) <math>C_{CB}</math></p> $C_{CB} = C_{ob} \text{ (WITH EMITTER GUARDED)}$ $C_{CB} = C_{ob}$

$CG_e, CG_b$

**Conversion Gain, Common-Emitter or Common-Base**

The ratio of the output power of a mixer, at one specified frequency, to its input power, at another specified frequency. This parameter is a function of oscillator injection voltage and the mixer operating point.

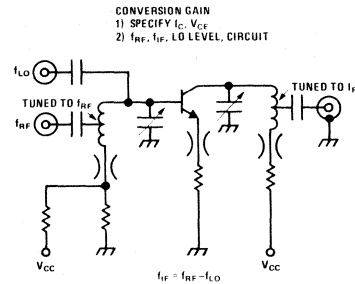

$f_{\alpha b}, f_{h_{fb}}$

**Common-Base Cut Off Frequency**

The frequency at which the  $h_{fb}$  ( $\alpha$ ) is reduced to 0.707 of its low frequency value.

$f_{\beta}, f_{h_{fe}}$

**Common-Emitter Cut Off Frequency**

The frequency at which the  $h_{fe}$  ( $\beta$ ) is reduced to 0.707 of its low frequency value.

**Gain Band-Width Product**

The common-emitter current gain band-width product in the frequency range where the current gain is falling at approximately 6 db/octave.

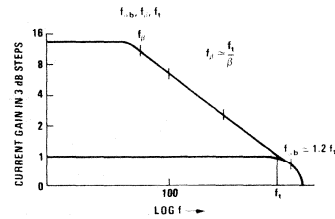

$f_t$

**Maximum Frequency of Oscillation**

This parameter is a device figure of merit that is calculated from  $f_t$  and  $r_b' C_c$ .

$f_{MAX} = \text{MAX FREQUENCY OF OSCILLATION FREQUENCY AT WHICH MAG} = 1$

$$f_{MAX} = \sqrt{\frac{f_T}{8\pi r_b C_c}} = f \sqrt{PG}$$

$G_e$

**Common-Emitter Power Gain**

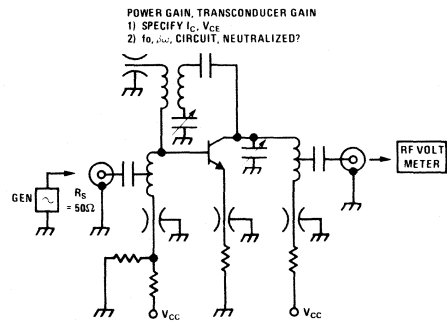

$C_{TE}$

**Common Emitter Transducer Gain**

A test fixture must be specified.

$$G_{TE} = \frac{\text{POWER DELIVERED TO THE LOAD}}{\text{POWER AVAILABLE FROM THE SOURCE}}$$

$G_{MA}$

**Stability Limited Gain or Gain Maximum Available**

This parameter is a device figure of merit and must be calculated from the two port "y" parameters.

$$G_{MA} = 10 \text{ LOG } \left[ \frac{|Y_{fe}|}{|Y_{re}|} \left( K - \sqrt{K^2 - 1} \right) \right]$$

NOT DEFINED FOR  $K < 1$

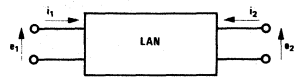
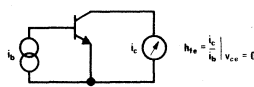
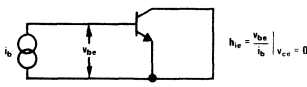
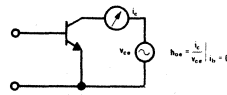
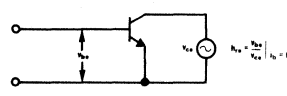
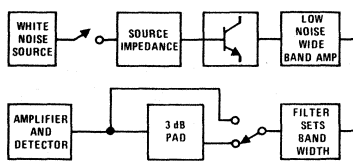
	<p style="text-align: center;"><b>h - PARAMETERS</b></p>  <p>WHERE <math>e_1, i_1, e_2, i_2</math> ARE SMALL SIGNAL VOLTAGES AND CURRENTS          THE h - (HYBRID) PARAMETERS ARE DEFINED BY  <math display="block">e_1 = h_{11} i_1 + h_{12} e_2</math> <math display="block">i_2 = h_{21} i_1 + h_{22} e_2</math>         AND FOR COMMON EMITTER OPERATION THESE E Q BECOME  <math display="block">e_1 = h_{ie} i_1 + h_{re} e_2</math> <math display="block">i_2 = h_{fe} i_1 + h_{oe} e_2</math></p>
<p><b><math>h_{fe}</math></b></p> <p><b>Common-Emitter Current Gain</b></p> <p>The common-emitter forward current transfer ratio with output ac shorted. This is a complex quantity.</p>	<p style="text-align: center;"><b>h - PARAMETERS - COMMON EMITTER</b></p>  <p style="text-align: right;"><math>h_{fe} = \frac{i_c}{i_b} \Big _{v_{ce} = 0}</math></p>
<p><b><math>h_{ie}</math></b></p> <p><b>Common-Emitter Input Impedance</b></p> <p>The common-emitter input impedance with the output ac shorted. This is a complex quantity.</p>	 <p style="text-align: right;"><math>h_{ie} = \frac{v_{be}}{i_b} \Big _{v_{ce} = 0}</math></p>
<p><b><math>h_{oe}</math></b></p> <p><b>Common-Emitter Output Admittance</b></p> <p>The common-emitter output admittance with the input ac open. This is a complex quantity.</p>	 <p style="text-align: right;"><math>h_{oe} = \frac{i_c}{v_{ce}} \Big _{i_b = 0}</math></p>
<p><b><math>h_{re}</math></b></p> <p><b>Common-Emitter Reverse Voltage Transfer Ratio</b></p> <p>The common-emitter reverse voltage transfer ratio with input ac open. This is a complex quantity.</p>	 <p style="text-align: right;"><math>h_{re} = \frac{v_{be}}{v_{ce}} \Big _{i_b = 0}</math></p>
<p><b>MAG</b></p> <p><b>Maximum Available Gain</b></p> <p>Device figure of merit that must be calculated from the two port "y" parameters.</p>	$MAG = 10 \text{ LOG } \frac{ Y_{21} ^2}{4 \text{ Re } (Y_{11}) \text{ RE } (Y_{22})}$
<p><b>MSG</b></p> <p><b>Maximum Stable Gain</b></p> <p>This parameter is a device figure of merit that is calculated from the two port "y" parameters.</p>	$MSG = 10 \text{ LOG } \frac{ Y_{fe} }{ Y_{re} }$
<p><b>NF</b></p> <p><b>Noise Figure</b></p> <p>Noise figure = <math>10 \log_{10} F</math>, where F is the ratio of total output noise power to the output power due solely to the thermal noise of the source impedance.</p>	<p style="text-align: center;">NOISE FIGURE MUST SPECIFY          1) <math>V_{ce}, I_c</math>          2) <math>R_s, f_o, \text{PBW}</math></p> 

$r_{bb}'$ ,  $r_b'$       **Base << Spreading >> Resistance**  
 Equivalent to the real part of  $h_{ie}$  at some specified very high frequency.

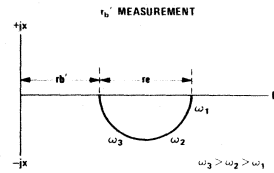

$r_b' C_c$       **Collector Base Time Constant**  
 This parameter is a device figure of merit and is measured in a specified test circuit.

$r_b' C_c =$  COLLECTOR BASE TIME CONSTANT SPECIFY -  $I_C$ ,  $V_{CE}$ , FREQUENCY

**Common-Emitter Switching Parameters**  
 In the following, drive circuit conditions and collector circuit conditions must be specified. The transition times of the input must be negligible compared to the measured times.

$t_d$       **Delay Time**  
 The time interval during turn-on from the point when the input pulse at the base reaches 10% of its full amplitude to the point when the collector pulse changes from 0 to 10% of its maximum amplitude.

$t_r$       **Rise Time**  
 The time interval during turn-on in which the collector pulse changes from 10% to 90% of its maximum amplitude.

$t_s$       **Storage Time**  
 The time interval during turn-off from the point when the turn-off pulse at the base changes from 100% to 90% of its full amplitude to the time when the collector current has changed from 100% to 90% of its maximum amplitude.

$t_f$       **Fall Time**  
 The time interval during turn-off in which the collector pulse decreases from 90% to 10% of its maximum amplitude.

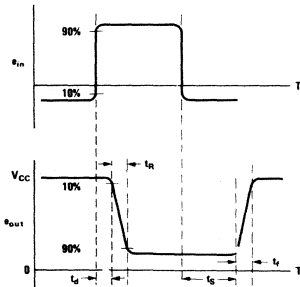
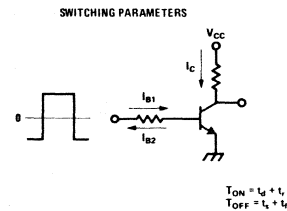

**y Parameters**

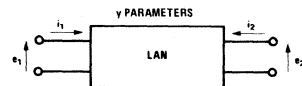

**y PARAMETERS ARE DEFINED BY**  
 $i_1 = Y_{11} e_1 + Y_{12} e_2$   
 $i_2 = Y_{21} e_1 + Y_{22} e_2$   
**OR IN COMMON EMITTER NOTATION**  
 $i_1 = Y_{ie} e_1 + Y_{oe} e_2$   
 $i_2 = Y_{fe} e_1 + Y_{fe} e_2$

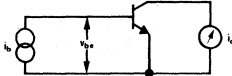
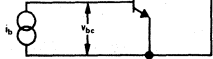
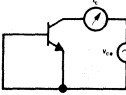
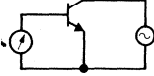

<p><math>Y_{fe}</math></p>	<p><b>Common-Emitter Forward Transfer Admittance</b></p> <p>The common-emitter forward transfer admittance with output ac shorted. This is a complex quantity (<math>g_{fe} + jb_{fe}</math>).</p>	 <p><math>Y_{fe} = \frac{i_c}{v_{fe}} \Big _{v_{ce} \approx 0}</math></p>
<p><math>Y_{ie}</math></p>	<p><b>Common-Emitter Input Admittance</b></p> <p>The common-emitter input admittance with output ac shorted. This is a complex quantity (<math>g_{ie} + b_{ie}</math>).</p>	<p><b>y PARAMETERS—COMMON EMITTER</b></p>  <p><math>Y_{ie} = \frac{i_b}{v_{ie}} \Big _{v_{ce} = 0}</math></p>
<p><math>Y_{oe}</math></p>	<p><b>Common-Emitter Output Admittance</b></p> <p>The common-emitter output admittance with input ac open. This is a complex quantity (<math>g_{oe} + jb_{oe}</math>).</p>	 <p><math>Y_{oe} = \frac{i_c}{v_{oe}} \Big _{v_{in} = 0}</math></p>
<p><math>Y_{re}</math></p>	<p><b>Common-Emitter Reverse Transfer Admittance</b></p> <p>The common-emitter reverse transfer admittance with input ac shorted. This is a complex quantity (<math>g_{re} + jb_{re}</math>).</p>	 <p><math>Y_{re} = \frac{i_b}{v_{re}} \Big _{v_{in} = 0}</math></p>

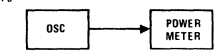
**LARGE SIGNAL PARAMETERS**

<p><math>\eta</math></p>	<p><b>Collector Efficiency</b></p> <p>This parameter applies to oscillators and class C amplifiers, predominantly. It is defined as the ratio of RF Power Out/DC Power In.</p>	<p><math>\eta</math> — COLLECTOR EFFICIENCY</p> $\eta = \frac{P_o \text{ (RF)}}{P_{in} \text{ (DC)}} = \frac{v_i}{I_C \times V_{CE}}$
<p><math>P_o</math></p>	<p><b>Power Out</b></p> <p>This parameter applies to oscillators. The units are watts and a test circuit must be specified.</p>	 <p><b>SPECIFY — <math>I_C, V_{CE}</math> UNDER QUIESCENT CONDITIONS</b> — <math>I_o, R_{LOAD}</math></p>

**THERMAL PARAMETERS**

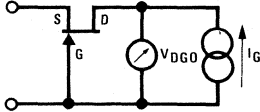
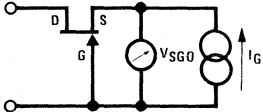
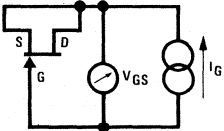
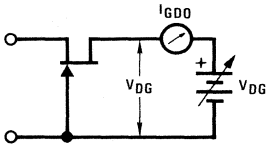
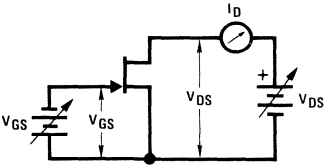
<p><math>R_{TH}</math></p>	<p><b>Internal Junction-to Case Thermal Resistance</b></p> <p>The rated increase of junction temperature with respect to the case temperature per unit of dissipated power. It is also called Thermal Resistance with infinite heat sink.</p>	
<p><math>\theta_{JC}</math></p>	<p><b>Junction-to Case Thermal Rating</b></p>	
<p><math>\theta_{JA}</math></p>	<p><b>Junction-to Ambient Thermal Rating</b></p>	

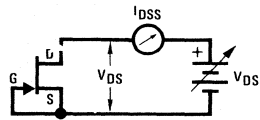
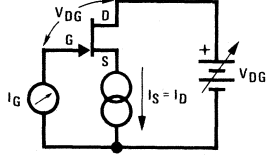
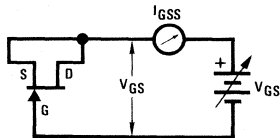
DC PARAMETERS		
$BV_{DGO}$ (V) or $BV_{GDO}$	<b>Drain-Gate Breakdown Voltage with Source Open-Circuited</b>	
$BV_{SGO}$ (V) or $BV_{GSO}$	<b>Source-Gate Breakdown Voltage with Drain Open-Circuited</b>	
$BV_{GSS}$ (V) or $BV, V_{(BR)GSS}$	<b>Source-Gate Breakdown Voltage with Drain-Source Shorted</b>	
$I_{DGO}$ (pA) or $I_{GDO}$	<b>Drain-Gate Leakage Current, Source Open-Circuited</b>	
$I_D$ (μA) or $I_{D(ON)}$	<b>Drain ON Current</b>	
$I_{D(OFF)}$ (pA)	<b>Drain Cutoff Current</b>	
$I_{DSS}$ (mA)	<b>Drain Saturation Current</b>	
$I_G$ (pA) or $I_{G(ON)}$	<b>Gate Leakage Current with Drain Current Flowing</b>	
$I_{GSS}$ (pA)	<b>Gate-Source Reverse Leakage Current with Drain-Source Shorted</b>	

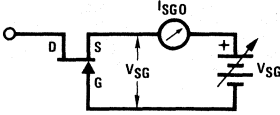
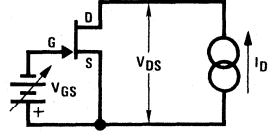
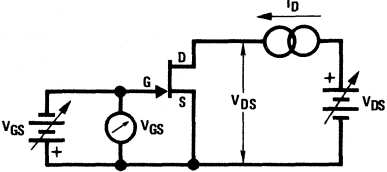
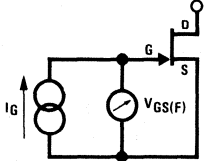
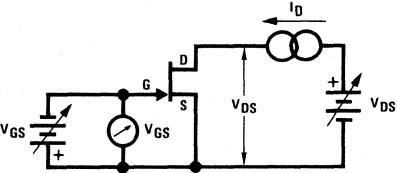
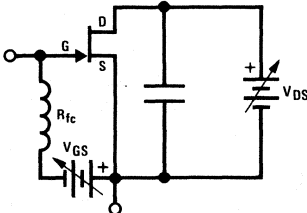
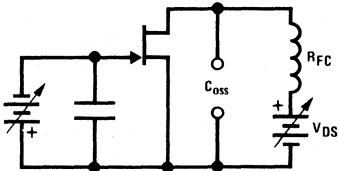
<p><math>I_{SGO}</math> (pA) or <math>I_{GSO}</math></p>	<p><b>Source-Gate Reverse Leakage Current with Drain Open-Circuited</b></p> <p>The leakage current of the source-gate junction, measured at a specified voltage, with the drain open-circuited.</p>	
<p><math>r_{DS}</math> (<math>\Omega</math>) or <math>r_{ds}</math>, <math>R_{DS}</math>, <math>r_{DS(ON)}</math></p>	<p><b>Drain-Source ON Resistance</b></p> <p>The drain-source ON resistance, measured at a specified gate-source voltage and drain current.</p>	
<p><math>V_{DS(ON)}</math> (mV)</p>	<p><b>Drain-Source ON Voltage</b></p> <p>The drain-source ON voltage, measured at a specified gate-source voltage and drain current.</p>	<p><math>r_{DS} = \frac{V_{DS}}{I_D}</math></p>
<p><math>V_{GS}</math> (V) or <math>V_{GS(ON)}</math>, <math>V_G</math></p>	<p><b>Operating Gate-Source Voltage</b></p> <p>The gate-source voltage, measured at a specified drain current and drain-source voltage.</p>	
<p><math>V_{GS(F)}</math> (V)</p>	<p><b>Forward Gate-Source Voltage</b></p> <p>The forward gate-source voltage, measured at specified current.</p>	
<p><math>V_{GS(OFF)}</math> (V) or <math>V_p</math></p>	<p><b>Gate-Source Cutoff (Pinch-Off) Voltage</b></p> <p>The gate-source cutoff voltage, measured at a specified drain current and drain-source voltage.</p>	
<b>SMALL SIGNAL PARAMETERS</b>		
<p><math>C_{iss}</math> (pF) or <math>C_{iss}</math>, <math>C_{gss}</math></p>	<p><b>Common-Source Input Capacitance</b></p> <p>The common-source input capacitance measured between the gate and source with the drain A-C shorted to the source at specified drain-source and gate-source voltages.</p>	
<p><math>C_{oss}</math> (pF) or <math>C_{os}</math>, <math>C_{dss}</math></p>	<p><b>Common-Source Output Capacitance</b></p> <p>The common-source output capacitance, measured between the drain and source with the source A-C shorted to the gate at specified drain-source and gate-source voltages.</p>	

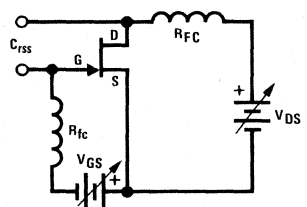
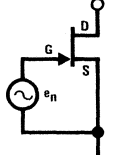
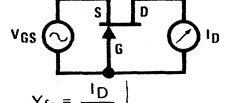
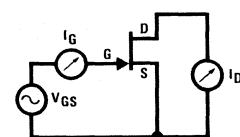
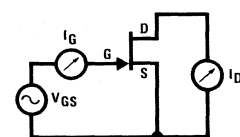
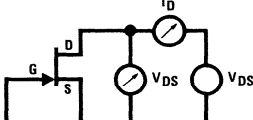
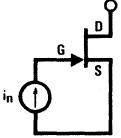

<p><math>C_{rss}</math> (pF) or <math>C_{rs}, C_{dg}</math></p>	<p><b>Common-Source Reverse Transfer Capacitance</b></p> <p>The common-source reverse transfer capacitance, measured between the drain and gate at specified drain-source and gate source voltages.</p>	
<p><math>e_n</math> (nV/√Hz) or <math>e_n, V_n, E_n</math></p>	<p><b>Equivalent Input Noise Voltage</b></p> <p>The equivalent input noise voltage per unit bandwidth, measured with the input A-C shorted to the source at a specified operating condition.</p>	
<p><math>g_{fg}</math> (mV) or <math>y_{fg}</math></p>	<p><b>Common-Gate Forward Transconductance</b></p> <p>The common-gate forward transconductance with the output A-C shorted. This is a complex quantity (<math>g_{fg} + j b_{fg}</math>).</p>	 $Y_{fg} = \frac{I_D}{V_{GS}} \Big _{V_{DS} = 0}$
<p><math>g_{fs}</math> (mV) or <math>g_m, Y_{fs}</math> <math>Re\{Y_{fs}\}</math></p>	<p><b>Common-Source Forward Transconductance</b></p> <p>The common source forward transconductance with the output A-C shorted. This is a complex quantity (<math>g_{fs} + j b_{fs}</math>).</p>	$Y_{fs} = \frac{I_D}{V_{GS}} \Big _{V_{DS} = 0}$ 
<p><math>g_{iss}</math> (μV) or <math>Y_{is}</math></p>	<p><b>Common-Source Input Conductance</b></p> <p>The common-source input conductance with the output A-C shorted. This is a complex quantity (<math>g_{is} + j b_{is}</math>).</p>	 $Y_{is} = \frac{I_G}{V_{GS}} \Big _{V_{DS} = 0}$
<p><math>g_{oss}</math> (μV) or <math>Y_{os}</math></p>	<p><b>Common-Source Output Conductance</b></p> <p>The common source output conductance with the input A-C shorted. This is a complex quantity (<math>g_{os} + j b_{os}</math>).</p>	 $Y_{os} = \frac{I_D}{V_{DS}} \Big _{V_{GS} = 0}$
<p><math>G_{pg}</math> (dB)</p>	<p><b>Common-Gate Power Gain</b></p> <p>The common-gate power gain is the ratio of output power to input power.</p>	$G_p = 10 \log_{10} \frac{P_o}{P_i}$
<p><math>G_{ps}</math> (dB)</p>	<p><b>Common-Source Power Gain</b></p> <p>The common-source power gain is the ratio of output power to input power.</p>	
<p><math>i_n</math> (pA/√Hz)</p>	<p><b>Equivalent Input Noise Current</b></p> <p>The equivalent input noise current measured with the input open-circuited under specified operating conditions.</p>	

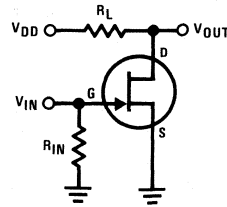
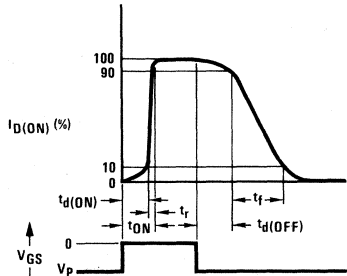
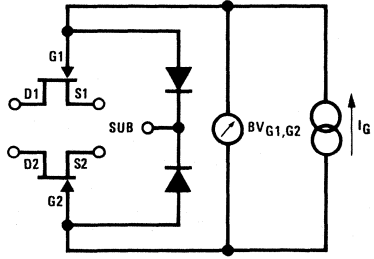
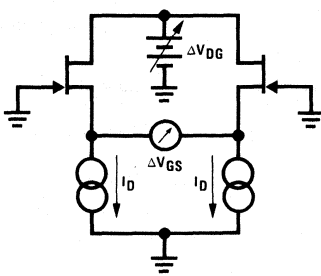
<p>NF (dB)</p>	<p><b>Spot Noise Figure</b></p> <p>Noise figure = <math>10 \log_{10} F</math> where F is noise factor which is the ratio of the total output noise power to the output noise power of the source. Measured at specified operating conditions and source resistance.</p>	$F = \frac{\text{Total Output Noise Power}}{\text{Source Output Noise Power}}$
<p><b>COMMON-SOURCE SWITCHING PARAMETERS</b></p>		
<p><math>t_d(\text{ON})</math></p>	<p><b>Turn-On Delay Time</b></p> <p>The time interval during turn-on from the point when the input pulse at the gate reaches 10% of its full amplitude to the point when the drain pulse changes from 0 to 10% of its maximum amplitude.</p>	
<p><math>t_r</math></p>	<p><b>Rise Time</b></p> <p>The time interval during turn-on in which the drain current pulse changes from 10% to 90% of its maximum amplitude.</p>	$I_{D(\text{ON})} = \frac{V_{DD} - V_{DS(\text{ON})}}{R_L}$
<p><math>t_d(\text{OFF})</math></p>	<p><b>Turn-Off Delay Time</b></p> <p>The time interval during turn-off from the point when the turn-off pulse at the gate changes from 100% to 90% of its full amplitude to the time when the drain current has changed from 100% to 90% of its maximum amplitude.</p>	
<p><math>t_f</math></p>	<p><b>Fall Time</b></p> <p>The time interval during turn-off in which the drain current pulse decreases from 90% to 10% of its maximum amplitude.</p>	
<p><b>DUAL FET PARAMETERS</b></p>		
<p><math>BV_{G1, G2}</math> (V) or <math>BV_{G1-2}</math></p>	<p><b>Gate to Gate Breakdown Voltage</b></p> <p>The breakdown voltage of the gate to gate junctions, measured at a specified current.</p>	
<p>CMRR (dB) or CMR</p>	<p><b>Common-Mode Rejection Ratio</b></p> <p>The common-mode rejection ratio is the ratio of the change in differential gate voltage with a change in the drain to gate voltage.</p> $\text{CMRR} = 20 \log_{10} \frac{\Delta V_{DG}}{\Delta V_{GS}}$	

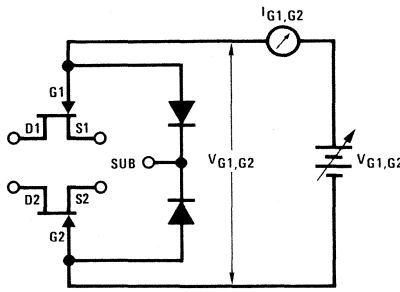
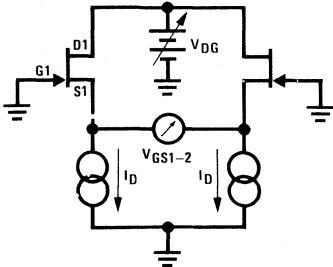
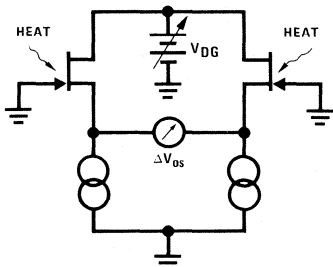
<p><math>g_{fs1-2}</math> (%) or <math>g_{fs1}/g_{fs2}</math></p>	<p><b>Common-Source Forward Transconductance Ratio (Match)</b></p> <p>The transconductance ratio = <math>g_{fs1}/g_{fs2} \times 100</math> (%) measured at specified drain-gate voltage and drain current.</p>	
<p><math>g_{os1-2}</math> (<math>\mu V</math>) or <math>g_{os1-2}</math></p>	<p><b>Common-Source Output Conductance (Match)</b></p> <p>Output conductance match = <math> g_{os1}-g_{os2} </math> measured at specified drain-gate voltage and drain current.</p>	
<p><math>I_{DSS1-2}</math> (%) or <math>I_{DS1-2}</math>. <math>I_{DSS1}/I_{DSS2}</math></p>	<p><b>Drain Saturation Current Ratio (Match)</b></p> <p>The drain saturation current ratio = <math>I_{DSS1}/I_{DSS2} \times 100\%</math> measured at specified drain-source voltages.</p>	
<p><math>I_{G1-2}</math> (pA)</p>	<p><b>Differential Gate Leakage Current</b></p> <p>Differential gate leakage current = <math> I_{G1}-I_{G2} </math> measured at specified drain-gate voltage and drain current.</p>	
<p><math>I_{G1, G2}</math> (pA)</p>	<p><b>Gate to Gate Reverse Leakage Current</b></p> <p>The gate to gate reverse leakage measured at a specified voltage monolithic dual with diode isolation shown.</p>	
<p><math>V_{GS1-2}</math> (mV) or <math>\Delta V_{GS}</math>, <math>V_{OS}</math>, <math> V_{GS1}-V_{GS2} </math></p>	<p><b>Differential Gate-Source Voltage</b></p> <p>The differential gate-source voltage, measured at a specified drain-gate voltage and drain current.</p>	
<p><math>\Delta V_{GS1-2}</math> (<math>\mu V/^{\circ}C</math>) or <math>\Delta V_{GS1}-V_{GS2} /\Delta T</math> <math>\Delta V_{OS}/\Delta T</math></p>	<p><b>Differential Gate-Source Voltage Drift</b></p> <p>The differential gate-source voltage drift is the change in the differential gate-source voltage with a change in device temperature at a specified operating condition.</p> $\frac{\Delta V_{OS}}{\Delta T} = \frac{ (V_{GS1}-V_{GS2}) _{T1} - (V_{GS1}-V_{GS2}) _{T2}}{T1-T2}$	

TO-3 (98)

SYMBOL	INCHES (MILLIMETERS)	
	MIN	MAX
A	0.250 (6.35)	0.450 (11.43)
$\phi E$	0.038 (0.965)	0.043 (1.092)
$\phi B$		0.875 (22.225)
K	0.420 (10.668)	0.440 (11.176)
M	0.205 (5.207)	0.225 (5.715)
C		0.135 (3.429)
D	0.312 (7.925)	
$\phi H$	0.151 (3.835)	0.161 (4.089)
F	1.177 (29.896)	1.197 (30.404)
r1		0.525 (13.335)
r2		0.188 (4.775)
G	0.655 (16.637)	0.675 (17.145)

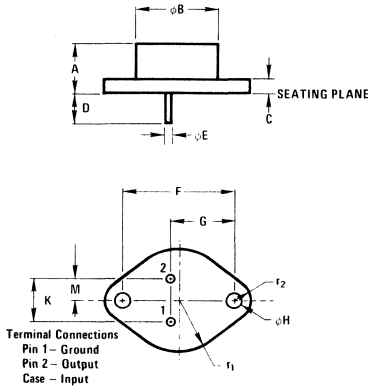

TO-5 (04)

PIN	T
1	E
2	B
3	C

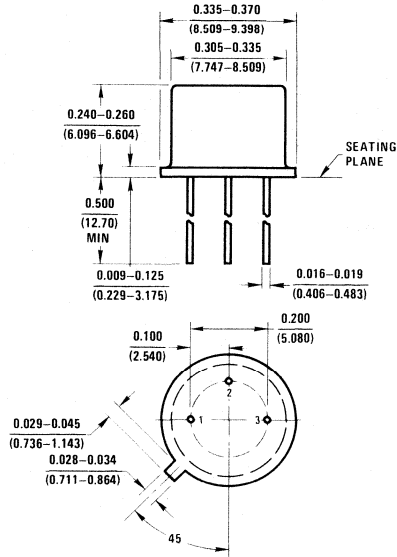

TO-18 (02, 11, 19)

PIN	T (02), (19)
1	E
2	B
3	C

PIN	FET N (02)
1	S
2	D
3	G

PIN	FET P (11)
1	S
2	G
3	D

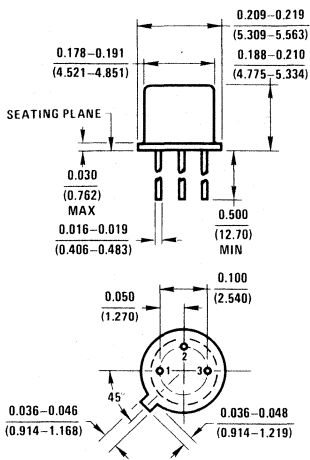

TO-39 (10, 16)\*

PIN	T
1	E
2	B
3	C

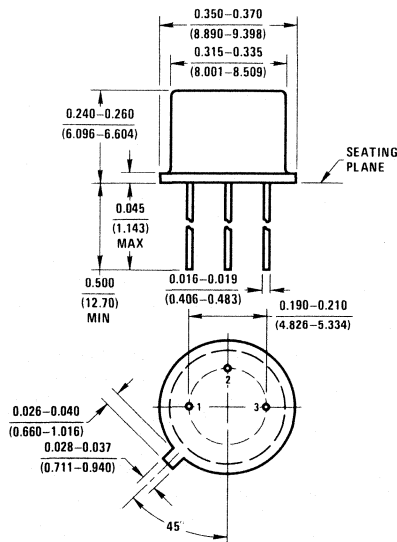

TO-39 (17) LO-PROFILE

PIN	T
1	E
2	B
3	C

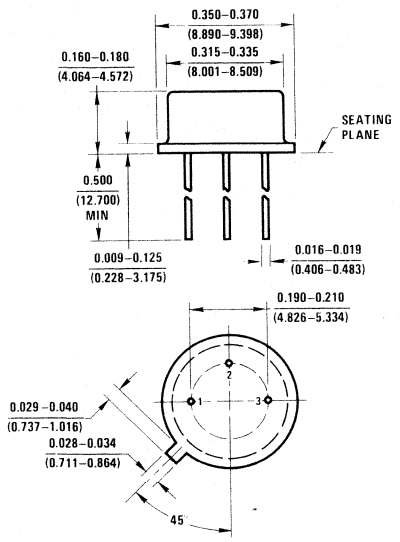

TO-46 (06)

PIN	T
1	E
2	B
3	C

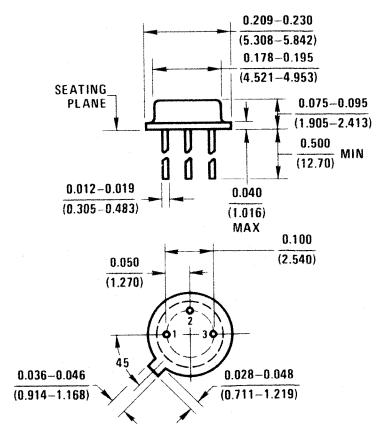

TO-52 (07, 18)

PIN	T (18)	FET (07)
1	E	S
2	B	D
3	C	G

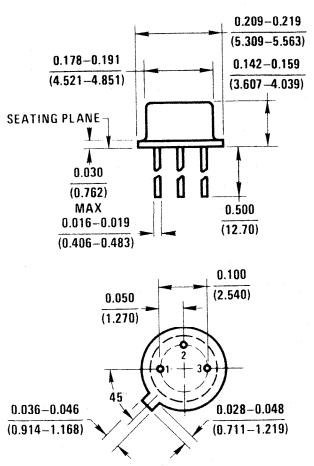

TO-71 (08, 12)

PIN	T (08)	FET (12)
1	E	S1
2	B	D1
3	C	G1
5	E	S2
6	B	D2
7	C	G2

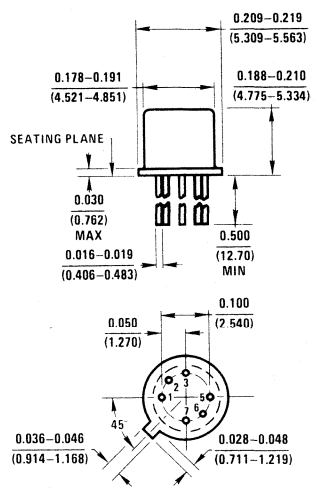

TO-72, (23, 25, 28, 29)

PIN	T (25)	FET N (25, 29)
1	E	S
2	B	D
3	C	G
4	GND	CASE

PIN	T (28)	FET P (23)
1	B	S
2	E	G
3	C	D
4	GND	CASE

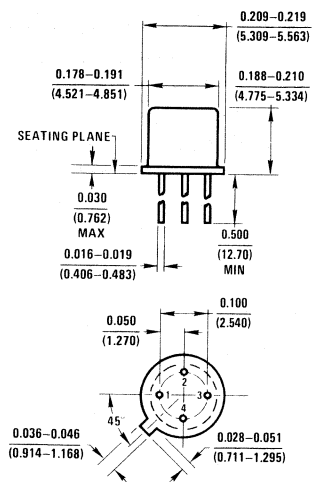

TO-78 (24, 27)

PIN	T (27)	FET (24)
1	C	S1
2	B	D1
3	E	G1
5	E	S2
6	B	D2
7	C	G2

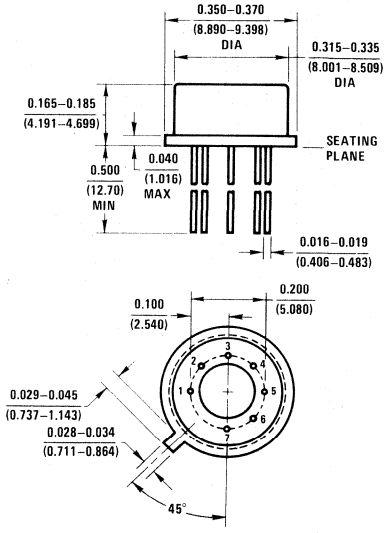

TO-92 (71, 72, 74, 76, 77, 78)

PIN	75/72 (Std)	
	T	FET
1	C	G
2	B	S
3	E	D

PIN	76/71	
	T	FET
1	C	G
2	E	D
3	B	S

PIN	74	
	T	FET
1	B	S
2	C	G
3	E	D

PIN	77	
	T	FET
1	E	D
2	B	S
3	C	G

PIN	78	
	T	FET
1	B	S
2	E	D
3	C	G

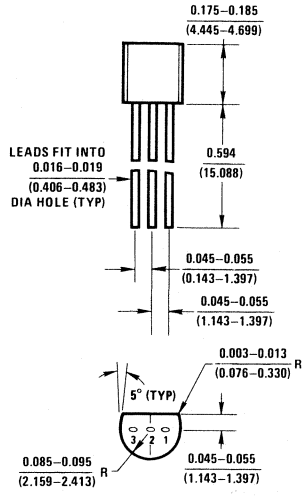

92-PLUS (90, 91)

PIN	PACKAGE 90	PACKAGE 91
1	Base	Collector
2	Collector	Base
3	Emitter	Emitter

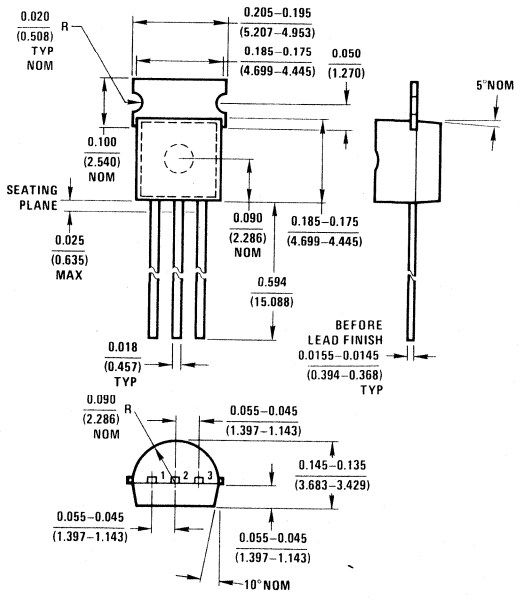

TO-99 (22)

PIN	FET
1	S
2	D
3	G
4	SUB
5	S
6	D
7	G
8	NC

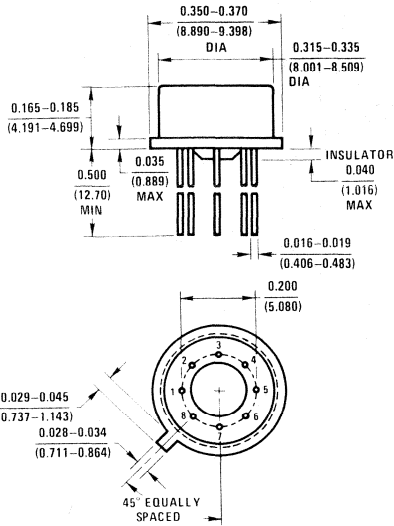

TO-126 (38)

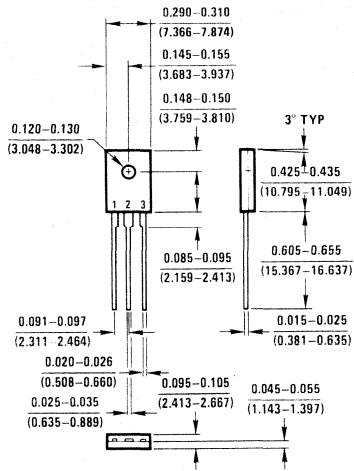

- Pin 1. Emitter
- 2. Collector
- 3. Base

When mounting the device, torque not to exceed 6.0 in lb.  
 If lead bending is required, use suitable clamp or other supports between transistor case and point of bend.

TO-220 (37)

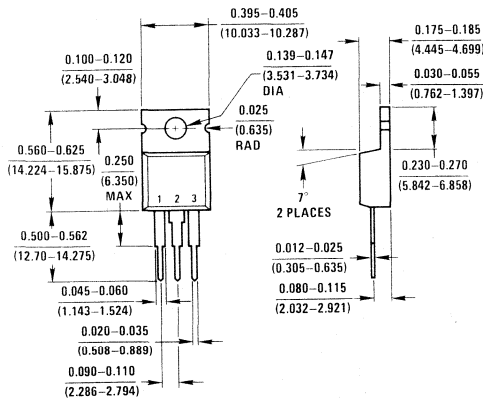

- Pin 1. Base
- 2. Collector
- 3. Emitter

TO-202 (35, 36)

PIN	PACKAGE 35	PACKAGE 36
	T	T
1	Emitter	Emitter
2	Base	Collector
3	Collector	Base

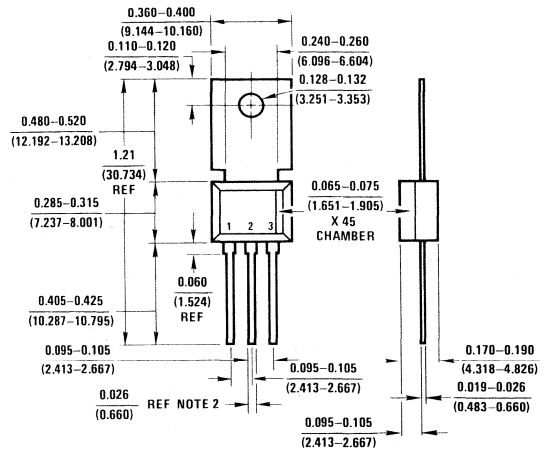

NOTES:  
 1. ALL DIM. ARE IN INCHES AND ARE REF. UNLESS TOLERANCED.  
 2. .943-.957 LEAD WIDTH WITHIN 0.100 OF BODY.

CAVITY DUAL-IN-LINE PACKAGE D (40)

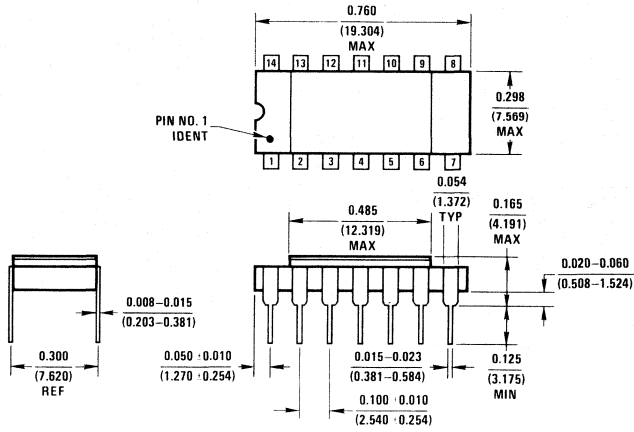

MOLDED MINI-DIP (60, 67)

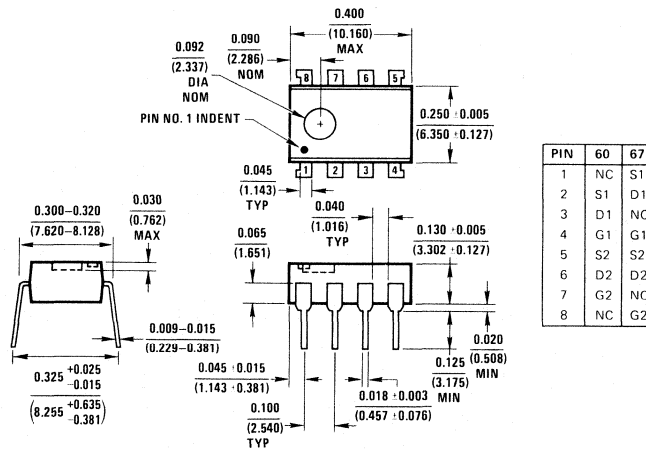

PIN	60	67
1	NC	S1
2	S1	D1
3	D1	NC
4	G1	G1
5	S2	S2
6	D2	D2
7	G2	NC
8	NC	G2



MOLDED DUAL-IN-LINE PACKAGE N (39)

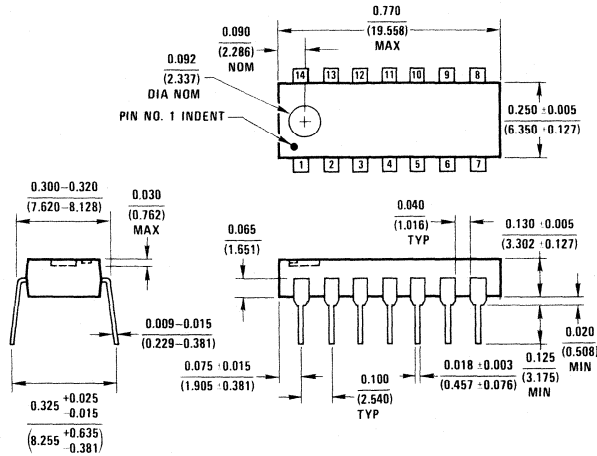

NS PACKAGE CODE	JEDEC CODE	NS PACKAGE CODE	JEDEC CODE
02	TO-18 Glass	37	TO-220 BCE
03	TO-5 Glass	38	TO-126 ECB
04	TO-5 Glass	39	TO-116 14-Lead M/DIP CN
05	TO-71 Diff. Amp. TO-18	40	TO-116 14-Lead Ceramic DIP CD
06	TO-46 Solid	41	TO-116 14-Lead Molded Array
07	TO-52 Solid	56	TO-100 10-Lead Header
08	TO-71 Diff. Amp. TO-18	57	TO-100 10-Lead Header
09	TO-39 Solid Kovar	58	16-Lead Side Braze DIP
10	TO-39 Solid Steel	59	16-Lead Size Braze DIP
11	TO-18 Glass SDG	60	8-Lead Molded DIP, Plastic (CN)
12	TO-71 Glass TO-18 Diff. Amp.	61	14-Lead Molded DIP, Plastic (CN)
13	TO-46 Header/TO-72 Can (4-Lead)	62	16-Lead Molded DIP, Plastic (CN)
16	TO-39 Solid Kovar	63	14-Lead Side Braze DIP
17	TO-39 Solid Steel Low Profile	64	14-Lead Side Braze DIP
18	TO-52 Glass	65	14-Lead Ceramic DIP (CJ)
19	TO-18 Solid	66	16-Lead Ceramic DIP (CJ)
22	TO-5 10-Lead	67	8-Lead Molded DIP (CN)
23	TO-72 Glass 4-Lead TO-18 SGD	69	TO-92 3-Lead Top Gate Plastic GSD
24	TO-78 Glass TO-5 Diff. Amp.	71	TO-92 BEC
25	TO-72 4-Lead TO-18 EBC	72	TO-92 EBC
27	TO-78 Diff. Amp. TO-5	74	TO-92 ECB
28	TO-72 4-Lead TO-18 BEC	75	TO-92 Faraday Shield EBC
29	TO-72 Glass TO-18 SDG 4-Lead Top Gate	76	TO-92 Faraday Shield BEC
30	TO-78 Diff. Amp. TO-5	77	TO-92 CBE
31	TO-202 ECB	78	TO-92 Faraday Shield CEB
32	TO-126 EC-	79	TO-92 C-E
35	TO-202 EBC	90	Mini-Watt ECB
36	TO-202 BCE	91	Mini-Watt EBC
		98	TO-3





Section 1

**NPN Transistors**

**1**

# NPN Transistors

## SATURATED SWITCHES

Type No.	Case Style	V <sub>CE</sub> * V <sub>CSO</sub> (V) Min	V <sub>CEO</sub> (V) Min	V <sub>EB0</sub> (V) Min	I <sub>CS</sub> * I <sub>CS0</sub> (mA) Max	V <sub>CB</sub> @ (V)	h <sub>FE</sub> @ (mA) Min Max	I <sub>C</sub> @ (mA) Min Max	V <sub>CE(sat)</sub> (V) Max	V <sub>BE(sat)</sub> (V) Min Max	I <sub>C</sub> @ (mA) Min Max	C <sub>ob</sub> (pF) Max	f <sub>T</sub> (MHz) Min Max	I <sub>C</sub> (mA) Max	t <sub>(off)</sub> (ns) Max	Test Condition	Process No.
2N1706	TO-18	25	15	5	500	15	20	10	0.6	0.7	0.9	6	200	10	75	2	21
2N1706J	TO-52	25	15	5	100	15	30	10	0.5	0.7	0.9	6	200	10	75	2	21
2N1708	TO-52	40	15	5	25	20	30	10	0.4	0.72	0.8	6	300	10			22
2N1743	TO-52		12		1 μA	20	10	100	0.65	0.85	1.0	5	300	10	24	1	21
2N1744	TO-52	20	12	5	1 μA	20	20	100	0.65	0.85	1.0	5	280	10	24	1	21
2N1753	TO-52	25	15	5	500	15	40	10	0.6	0.7	0.9	5	200	10	75	2	21
2N1834	TO-52	40	15	5	500	20	25	10	0.25	0.9	1.0	4	350	10	30	2	21
2N2369	TO-52	40	15	4.5	400	20	20	100	0.25	0.7	0.85	4	500	10	18	1	21
2N2369A	TO-52	40	15	4.5	30	20	20	100	0.20	0.7	0.85	4	500	10	18	1	21
2N2369A J, JTX, JTXV	TO-18	40	15	4.5	400*	20	20	100	0.2	0.7	0.85	4	500	10	18	1	21
2N3009	TO-52	40	15	4	500*	20	15	300	0.18	0.75	0.95	5	350	30	25	3	22
2N3011	TO-52	30	12	5	400*	20	12	100	0.2	0.72	0.85	4	400	20	20	4	21
2N3013	TO-52	40	15	5	300*	20	15	300	0.18	0.75	0.95	5	350	30	25	3	22
2N3015	TO-39	60	30	5	200	30	10	300	0.4	1.2	1.5	8	250	50	60	5 & 6	25
2N3252	TO-39	60	30	5	500	40	25	1A	0.3	1.0	1.5	12	200	50	70	7	25



**SATURATED SWITCHES (Continued)**

Type No.	Case Style	V <sub>CE</sub> * V <sub>CB0</sub> (V) Min	V <sub>CE0</sub> (V) Min	V <sub>EBO</sub> (V) Min	ICES* ICBO (mA) Max	V <sub>CB</sub> (V) @ Max	hFE Min Max	IC @ (mA) @ Max	V <sub>BE(sat)</sub> (V) Min Max	V <sub>CE(sat)</sub> (V) Max	ICES (mA) @ Max	C <sub>ob</sub> (pF) Max	f <sub>T</sub> (MHz) Min Max	IC (mA) Max	t <sub>(off)</sub> (ns) Max	Test Condition	Process No.
2N3253	TO-39	75	40	5	500	60	20 25 25	750 375 150	1.0 0.7 1.8	0.35 0.6 1.2	150 500 1A	12	175	50	70	7	25
2N3444	TO-39	80	50	5	500	60	15 20 20	1A 500 150	1.0 1.3 1.8	0.35 0.6 1.2	150 500 1A	12	150	50	70	7	25
2N3605	TO-92 (74)		14		500	18	30	10	0.85	0.25	10	6	300	10	45	2	21
2N3606	TO-92 (74)		14		500	18	30	10	0.85	0.25	10	6	300	10	60	2	21
2N3607	TO-92 (74)		14		500	18	30	10	0.85	0.25	10	6	300	10	70	2	21
2N3646	Same as PN3646, see page 1-6 for explanation																
2N3724	TO-39	50	30	6	1.7 μA	40	30 25 35 40 60 30	1A 800 500 300 100 10	1.1 0.9 1.2 1.5 1.7	0.32 0.42 0.65 0.75	300 500 800 1A	12	300	50	60	7	25
2N3724A	TO-39	50	30	6	500	40	25 30 35 40 60 30	1.5A 1A 800 500 300 100 10	1.1 1.2 1.3 1.4	0.32 0.42 0.65 0.75	300 500 800 1A	12	300	50	50	8	25
2N3725	TO-39	80	50	6	1.7 μA	60	25 20 35 40 60 30	1A 800 500 300 100 10	1.1 1.2 1.5 1.7	0.4 0.62 0.8 0.95	300 500 800 1A	10	300	50	60	7	25

**TEST CONDITIONS:**

- (1) V<sub>CC</sub> = 3V, I<sub>C</sub> = 10mA, I<sub>B</sub><sup>1</sup> = 3mA, I<sub>B</sub><sup>2</sup> = 1.5mA. (2) V<sub>CC</sub> = 3V, I<sub>C</sub> = 10mA, I<sub>B</sub><sup>1</sup> = 3mA, I<sub>B</sub><sup>2</sup> = 1mA. (3) V<sub>CC</sub> = 10V, I<sub>C</sub> = 300mA, I<sub>B</sub><sup>1</sup> = I<sub>B</sub><sup>2</sup> = 30mA. (4) V<sub>CC</sub> = 2V, I<sub>C</sub> = 30mA, I<sub>B</sub><sup>1</sup> = I<sub>B</sub><sup>2</sup> = 3mA.  
 (5) V<sub>CC</sub> = 25V, I<sub>C</sub> = 300mA, I<sub>B</sub><sup>1</sup> = I<sub>B</sub><sup>2</sup> = 30mA. (6) V<sub>CC</sub> = 25V, I<sub>C</sub> = 500mA, I<sub>B</sub><sup>1</sup> = I<sub>B</sub><sup>2</sup> = 50mA. (7) V<sub>CC</sub> = 30V, I<sub>C</sub> = 500mA, I<sub>B</sub><sup>1</sup> = I<sub>B</sub><sup>2</sup> = 50mA. (8) V<sub>CC</sub> = 30V, I<sub>C</sub> = 1A, I<sub>B</sub><sup>1</sup> = I<sub>B</sub><sup>2</sup> = 100mA.  
 (9) V<sub>CC</sub> = 3V, I<sub>C</sub> = 10mA, I<sub>B</sub><sup>1</sup> = I<sub>B</sub><sup>2</sup> = 1mA. (10) V<sub>CC</sub> = 10.7V, I<sub>C</sub> = 1A, I<sub>B</sub><sup>1</sup> = I<sub>B</sub><sup>2</sup> = 100mA. (11) V<sub>CC</sub> = 3V, I<sub>C</sub> = 10mA, I<sub>B</sub><sup>1</sup> = I<sub>B</sub><sup>2</sup> = 3mA. (12) V<sub>CC</sub> = 3V, I<sub>C</sub> = 10mA, I<sub>B</sub><sup>1</sup> = I<sub>B</sub><sup>2</sup> = 3.3mA.



## SATURATED SWITCHES (Continued)

Type No.	Case Style	V <sub>CE</sub> * V <sub>CSO</sub> (V) Min	V <sub>CEO</sub> (V) Min	V <sub>EBO</sub> (V) Min	I <sub>CS</sub> * I <sub>CBO</sub> (mA) Max	V <sub>CB</sub> (V) @ I <sub>C</sub> Max	h <sub>FE</sub> Min Max	I <sub>C</sub> (mA) & V <sub>CE</sub> (V)	V <sub>CE(sat)</sub> (V) Max	V <sub>BE(sat)</sub> (V) Min & Max	I <sub>C</sub> (mA) @ I <sub>B</sub> = I <sub>C</sub> /10	C <sub>ob</sub> (pF) Max	f <sub>T</sub> (MHz) Min Max	t <sub>(off)</sub> (ns) Max	Test Condition	Process No.
2N3725A	TO-39	80	50	6	500	60	20 25 25 35 40 60 30	1.5A 1A 800 500 300 100 10	0.4 0.52 0.8 0.9	1.1 1.2 1.3 1.4	300 500 800 1A	10		50	8	25
2N4013	TO-18	50	30	6	1.7 μA	40	30 25 35 40 60 30	1A 800 500 300 100 10	0.25 0.2 0.32 0.42 0.65 0.75	0.76 0.86 1.1 1.2 1.5 1.7	10 100 300 500 800 1A	12	300	60	7	25
2N4014	TO-18	80	50	6	1.7 μA	60	25 20 35 40 60 30	1A 800 500 300 100 10	0.25 0.26 0.4 0.25 0.8 0.9	0.76 0.86 1.1 1.2 1.5 1.7	10 100 300 500 800 1A	10	300	60	7	25
2N4047	TO-39	80	50	6	1.7 μA	60	15 15 20 30 40 20	1A 800 500 300 100 10	0.4 0.52 0.8	1.1 1.2 1.5	300 500 800 1A	10	250	60	7	25
2N4274	TO-92 (72)	Same as PNA4274, see page 1-6 for explanation														21
2N4275	TO-92 (72)	Same as PNA4275, see page 1-6 for explanation														21
2N4294	TO-92 (74)	30	12	4.5	400	20	20 30 20	100 120 10	0.25	0.6	10	5	400	20	1	21
2N4295	TO-92 (74)	40	15	5	100	20	20 40	100 120	0.25	0.6	10	4	500	15	1	21
2N5030	TO-92 (74)	30	12	4	250	20	30	10	0.25	0.72	10	4	400	30	9	21
2N5134	TO-92 (72)	Same as PNA5134, see page 1-6 for explanation														
2N5189	TO-39	60	35	5	500	30	15 35 30	1A 500 100	1.0	1.5	1A	12	250	70	10	25



### SATURATED SWITCHES (Continued)

Type No.	Case Style	V <sub>CE</sub> * V <sub>CB0</sub> (V) Min	V <sub>CE0</sub> (V) Min	V <sub>EB0</sub> (V) Min	I <sub>CB0</sub> * (mA) Max	V <sub>CB</sub> (V) Max	I <sub>FE</sub> Min (mA)	I <sub>C</sub> & V <sub>CE</sub> (V) (mA) (V)	V <sub>CE(sat)</sub> (V) Max	V <sub>BE(sat)</sub> (V) Min	I <sub>C</sub> (mA) @ I <sub>B</sub> = I <sub>C</sub> /10 Max	C <sub>ob</sub> (pF) Max	f <sub>T</sub> (MHz) Min	I <sub>C</sub> (mA) @ f <sub>T</sub> Max	t <sub>off</sub> (ns) Max	Test Condition	Process No.
2N5224	TO-92 (72)	25	12	5	500	15	15 40	100 10	0.35	0.9	10	4	250	10	60	11	21
2N5769	TO-92 (72)	40	15	4.5	400	20	20 30 40	100 30 10	0.2 0.25 0.5	0.7 1.5 1.6	10 30 100	4	500	10	18	1	21
2N5772	TO-92 (72)	40	15	5	500	20	15 25 30	300 100 30	0.2 0.28 0.5	0.75 1.2 1.7	30 100 300	5	350	30	28	3	21
DH3724CD	Ceramic DIP (40)	50*	36	60	1.7 μA	40	30 35 60	1A 500 100	0.75	1.7	500	12	300	50	60	7	25
DH3724CN	Molded DIP (39)	Electrical, same as DH3724CD															25
DH3725CD	Ceramic DIP (40)	80*	50	6	1.7 μA	60	25 35 60	1A 500 100	0.95	1.7	500	10	250	50	60	7	25
DH3725CN	Molded DIP (39)	Electrical, same as DH3725CD															25
EN2369A	TO-92 (72)	Same as PN2369A, see page 1-6 for explanation															21
MPS706	TO-92 (72)	15	15	3	500	15	20	10	0.6	0.9	10	6	200	10	75	11	21
MPS834	TO-92 (72)	40		5	500	20	25	10	0.25 0.4	0.9	10 50	4	350	10	30	2	21
MPS2369	TO-92 (72)	40*	15	4.5	400	20	20 40	100 10	0.25	0.7 0.85	10	4	500	10	18	7	21
MPS2713	TO-92 (72)	18	15	5	500	18	30	90	0.3	1.3	50						21
MPS2714	TO-92 (72)	18	15	5	500	18	75	225	0.3	0.6 1.3	50						21
MPS3646	TO-92 (72)	Same as PN3646, see page 1-6 for explanation															
PN2369	TO-92 (72)	40*	15	4.5	400	20	20 40	100 10	0.25	0.7 0.85	10	4	500	10	18	1	21

#### TEST CONDITIONS:

- (1) V<sub>CC</sub> = 3V, I<sub>C</sub> = 10mA, I<sub>B</sub><sup>1</sup> = 3mA, I<sub>B</sub><sup>2</sup> = 1.5mA, (2) V<sub>CC</sub> = 3V, I<sub>C</sub> = 10mA, I<sub>B</sub><sup>1</sup> = 3mA, I<sub>B</sub><sup>2</sup> = 1mA, (3) V<sub>CC</sub> = 10V, I<sub>C</sub> = 300mA, I<sub>B</sub><sup>1</sup> = I<sub>B</sub><sup>2</sup> = 30mA, (4) V<sub>CC</sub> = 2V, I<sub>C</sub> = 30mA, I<sub>B</sub><sup>1</sup> = I<sub>B</sub><sup>2</sup> = 3mA, (5) V<sub>CC</sub> = 25V, I<sub>C</sub> = 300mA, I<sub>B</sub><sup>1</sup> = I<sub>B</sub><sup>2</sup> = 30mA, (6) V<sub>CC</sub> = 25V, I<sub>C</sub> = 500mA, I<sub>B</sub><sup>1</sup> = I<sub>B</sub><sup>2</sup> = 50mA, (7) V<sub>CC</sub> = 30V, I<sub>C</sub> = 500mA, I<sub>B</sub><sup>1</sup> = I<sub>B</sub><sup>2</sup> = 50mA, (8) V<sub>CC</sub> = 30V, I<sub>C</sub> = 1A, I<sub>B</sub><sup>1</sup> = I<sub>B</sub><sup>2</sup> = 100mA, (9) V<sub>CC</sub> = 3V, I<sub>C</sub> = 10mA, I<sub>B</sub><sup>1</sup> = I<sub>B</sub><sup>2</sup> = 1mA, (10) V<sub>CC</sub> = 10.7V, I<sub>C</sub> = 1A, I<sub>B</sub><sup>1</sup> = I<sub>B</sub><sup>2</sup> = 100mA, (11) V<sub>CC</sub> = 3V, I<sub>C</sub> = 10mA, I<sub>B</sub><sup>1</sup> = I<sub>B</sub><sup>2</sup> = 3mA, (12) V<sub>CC</sub> = 3V, I<sub>C</sub> = 10mA, I<sub>B</sub><sup>1</sup> = I<sub>B</sub><sup>2</sup> = 3.3mA.





## SATURATED SWITCHES (Continued)

Type No.	Case Style	V <sub>CE</sub> * V <sub>CB0</sub> (V) Min	V <sub>CE0</sub> (V) Min	VEBO (V) Min	ICES* ICBO (mA) Max	hFE Min Max	IC & VCE (mA) & (V)	VCE(sat) (V) Max & VBE(sat) (V) Min	IC (mA) @ IC/IC <sub>10</sub> Max	C <sub>ob</sub> (pF) Max	f <sub>T</sub> (MHz) Min Max	t <sub>(off)</sub> (ns) Max	Test Condition	Process No.
PN2369A	TO-92 (72)	40*	15	4.5	30	20 30 40	100 30 10	0.2 0.2 0.5	0.85 1.15 1.6	4	500	18	1	21
PN3646	TO-92 (72)	40*	15	5	500*	15 20 30	300 100 30	0.2 0.28 0.5	0.95 1.2 1.7	5	350	28	3	22
PN4274	TO-92 (72)	30*	12	4.5	500	18 30 35	100 30 10	0.2 0.25 0.5	0.85 1.15 1.6	4	400	12	12	21
PN4275	TO-92 (72)	40*	15	4.5	500	18 30 35	100 30 10	0.2 0.25 0.5	0.85 1.15 1.6	4	400	12	12	21
PN5134	TO-92 (72)	20*	10	3.5	100	15 20	30 150	0.25 0.4	0.9 1	4	250	18	12	21

### TEST CONDITIONS:

- (1) V<sub>CC</sub> = 3V, I<sub>C</sub> = 10mA, I<sub>B</sub><sup>1</sup> = 3mA, I<sub>B</sub><sup>2</sup> = 1mA, I<sub>C</sub> = 10mA, I<sub>B</sub><sup>1</sup> = 3mA, I<sub>B</sub><sup>2</sup> = 1mA, (2) V<sub>CC</sub> = 3V, I<sub>C</sub> = 10mA, I<sub>B</sub><sup>1</sup> = 3mA, I<sub>B</sub><sup>2</sup> = 1mA, (3) V<sub>CC</sub> = 10V, I<sub>C</sub> = 300mA, I<sub>B</sub><sup>1</sup> = I<sub>B</sub><sup>2</sup> = 30mA, (4) V<sub>CC</sub> = 2V, I<sub>C</sub> = 30mA, I<sub>B</sub><sup>1</sup> = I<sub>B</sub><sup>2</sup> = 3mA, (5) V<sub>CC</sub> = 25V, I<sub>C</sub> = 300mA, I<sub>B</sub><sup>1</sup> = I<sub>B</sub><sup>2</sup> = 30mA, (6) V<sub>CC</sub> = 25V, I<sub>C</sub> = 500mA, I<sub>B</sub><sup>1</sup> = I<sub>B</sub><sup>2</sup> = 50mA, (7) V<sub>CC</sub> = 30V, I<sub>C</sub> = 500mA, I<sub>B</sub><sup>1</sup> = I<sub>B</sub><sup>2</sup> = 50mA, (8) V<sub>CC</sub> = 30V, I<sub>C</sub> = 1A, I<sub>B</sub><sup>1</sup> = I<sub>B</sub><sup>2</sup> = 100mA, (9) V<sub>CC</sub> = 3V, I<sub>C</sub> = 10mA, I<sub>B</sub><sup>1</sup> = I<sub>B</sub><sup>2</sup> = 1mA, (10) V<sub>CC</sub> = 10.7V, I<sub>C</sub> = 1A, I<sub>B</sub><sup>1</sup> = I<sub>B</sub><sup>2</sup> = 100mA, (11) V<sub>CC</sub> = 3V, I<sub>C</sub> = 10mA, I<sub>B</sub><sup>1</sup> = I<sub>B</sub><sup>2</sup> = 3mA, (12) V<sub>CC</sub> = 3V, I<sub>C</sub> = 10mA, I<sub>B</sub><sup>1</sup> = I<sub>B</sub><sup>2</sup> = 3.3mA.



## RF AMPS AND OSCILLATORS

Type No.	Case Style	V <sub>CE</sub> * V <sub>CB0</sub> (V) Min	V <sub>CE0</sub> (V) Min	VEBO (V) Min	ICBO (mA) Max	hFE Min Max	IC & VCE (mA) & (V)	VCE(SAT) (V) Max & VBE(SAT) (V) Min	IC (mA) @ IC/IC <sub>10</sub> Max	C <sub>ob</sub> /C <sub>re</sub> (pF) Min Max	f <sub>T</sub> (MHz) Min Max	IC (mA) @ IC/IC <sub>10</sub> Max	NF (dB) @ Max	Freq (MHz) Max	Process No.
2N917	TO-72	30	15	3	1	20	3	0.5	0.87	3	500	4	6	60	43
2N918	TO-72	30	15	3	10	20	3	0.4	1.0	10	600	4	6	60	43
2N918 J, JTX, JTXV	TO-72	30	15	3	10	20	10 200 10	0.4	1.0	10	600	4	6	60	43
2N2857	TO-72	30	15	2.5	10	30	150	0.4	1.0	10	1000	5	4.5	450	42
2N2857 J, JTX, JTXV	TO-72	30	15	3	10	30	150	0.4	1.0	10	1000	5	4.5	450	42
2N9478	TO-72	30	15	2	20	25	150	0.4	1.0	10	750	5	4.5	200	42





### RF AMPS AND OSCILLATORS (Continued)

Type No.	Case Style	V <sub>CE</sub> <sup>*</sup>		V <sub>CE0</sub> (V) Min	V <sub>EBO</sub> (V) Min	I <sub>CBO</sub> (mA) Max	V <sub>CB</sub> (V)	h <sub>FE</sub> Min	I <sub>C</sub> & V <sub>CE</sub> (mA) & (V)	V <sub>CE(SAT)</sub> (V) Max	V <sub>BE(SAT)</sub> (V) Min	I <sub>C</sub> @ (mA) Max	C <sub>ob/Cre</sub> (pF) Min	f <sub>T</sub> (MHz) Min	I <sub>C</sub> @ (mA) Max	NF (dB) @ (MHz) Max	Freq (MHz)	Process No.				
		V <sub>CE0</sub> (V) Min	V <sub>CB0</sub> (V) Min																			
2N3563	TO-92 (72)	Same as PN3563, see page 1-10 for explanation																				
2N3564	TO-92 (72)	Same as PN3564, see page 1-10 for explanation																				
2N3600	TO-72	30	15	3	10	15	1	20	150	3	1	850	1500	5	4.5	200	42	43				
2N3662	TO-92 (74)	18	12	3	500	15	10	20	8	10	0.8	1.7	700	2100	5	6.5	60	43				
2N3663	TO-92 (74)	30	12	3	500	15	10	20	8	10	0.8	1.7	700	2100	5	6.5	60	43				
2N3825	TO-92 (74)	30	15	4	100	15	10	20	2	10	0.25	2	200	800	2	5.5	1	43				
2N3932	TO-72	30	20	2.5	10	15	8	40	150	2	8	0.55	750	1600	2	4.5	200	42				
2N3933	TO-72	40	30	2.5	10	15	8	60	200	2	8	0.55	750	1600	2	4	200	42				
2N4134	TO-72	30	30	3	50	10	5	25	200	4	5	0.5	350	800	4	2.5	60	44				
2N4135	TO-72	30	30	3	50	10	5	25	200	4	5	0.5	425	800	4	5	450	44				
2N4252	TO-72	30	18	4	50	15	10	50	2	10	0.45	600	1400	2	5	450	42	42				
2N4259	TO-72	40	30	2.5	10	15	8	60	250	2	8	0.55	750	1600	2	5	450	42				
2N4292	TO-92 (74)	30	15	3	500	15	10	20	3	1	0.6	10	3.5	600	4	6	60	43				
2N4293	TO-92 (74)	30	15	3	500	15	10	20	3	1	0.6	10	3.5	600	4	6	60	43				
2N5130	TO-92 (72)	Same as PN5130, see page 1-10 for explanation																				
2N5179	TO-72	20	12	2.5	20	15	1	25	250	3	1	0.4	1.0	10	1	900	2000	5	4.5	200	42	
2N5180	TO-72	30	15	2	500	8	8	20	200	2	8	1	650	1700	2	4.5	200	42				
2N5222	TO-92 (71)	20	15	2	100	10	10	20	1500	4	10	1.0	1.2	10	4	450	4	49				
2N5770	TO-92 (72)	30	15	4.5	10	15	10	50	200	8	10	0.4	1.0	10	0.7	1.1	90	1800	8	6	60	43
40235	TO-72	35		3	1 μA	35	6	40	170	1	6	0.65						42				
40236	TO-72	35		3	1 μA	35	6	40	275	1	6	0.65						42				
40237	TO-72	35		3	1 μA	35	6	27	275	1	6	0.8						42				





## RF AMPS AND OSCILLATORS (Continued)

Type No.	Case Style	V <sub>CE</sub> <sup>*</sup> V <sub>CB0</sub> (V) Min	V <sub>CE0</sub> (V) Min	V <sub>EB0</sub> (V) Min	I <sub>CB0</sub> V <sub>CB</sub> (mA) @ (V) Max	h <sub>FE</sub> Min	h <sub>FE</sub> Max	I <sub>C</sub> & V <sub>CE</sub> (mA) (V) Max	V <sub>CE(SAT)</sub> V <sub>BE(SAT)</sub> (V) (V) Max Min	I <sub>C</sub> (mA) Max	C <sub>ob</sub> /C <sub>re</sub> (pF) Min Max	f <sub>T</sub> (MHz) Min Max	I <sub>C</sub> (mA) Max	NF (dB) @ (MHz) Max	Freq (MHz)	Process No.	
40238	TO-72	35		3	1 μA 35 20 1	40	170	1 6			0.65					42	
40239	TO-72	35		3	1 μA 35 20 1	27	100	1 6			0.65					42	
40240	TO-72	35		3	1 μA 35 20 1	27	275	1 6			0.65					42	
40242	TO-72	35		3	20 1	40	170	1 6			0.65					42	
40243	TO-72	35		3	20 1	40	170	1 6			0.65					42	
40244	TO-72	35		3	20 1	27	170	1 6			0.65					42	
40245	TO-72	35		3	20 1	70	170	1 6			0.8					42	
40246	TO-72	35		3	20 1	27	170	1 6			0.65					42	
EN918	TO-92 (72)	Same as PN918, see page 1-10 for explanation															43
MPSH07	TO-92 (75)	30	30	3	50 15	20	3	3 10			0.3	400	3	3.2	100	41	
MPSH08	TO-92 (75)	30	30	3	50 15	20	3	3 10			0.3	500	3	3.5	200	41	
MPSH10	TO-92 (71)	30	25	3	100 25	60	4	4 10	0.5	4	0.35	650	4			42	
MPSH11	TO-92 (76)	30	25	3	100 25	60	4	4 10	0.5	4	0.6	650	4			47	
MPSH19	TO-92 (76)	30	25	3	100 15	45	4	4 10			0.65	300	4			47	
MPSH20	TO-92 (71)	40	30	4	50 15	25	4	4 10	0.95	10	0.65	400	4			49	
MPSH24	TO-92 (47)	40	30	4	50 15	30	8	8 10			0.36	400	8			47	
MPSH30	TO-92 (71)	20	20	3	50 10	20	200	4 5	0.3	10	0.65	300	4	6	45	44	
MPSH31	TO-92 (71)	20	20	3	50 10	20	200	4 5	0.3	10	0.65	300	4	6	45	44	
MPSH32	TO-92 (76)	30	30	4	50 10	27	200	4 5	0.3	1.2	0.22	300	4			45	
MPSH34	TO-92 (76)	45	45	4	50 30	15	20	2 15	0.5	20	0.32	500	15			47	
MPSH37	TO-92 (71)		40	5	500 35	25	5	5 10	0.5	10	0.7	300	5			49	



RF AMPS AND OSCILLATORS (Continued)

Type No.	Case Style	V <sub>CE</sub> * V <sub>CB0</sub> (V) Min	V <sub>CE0</sub> (V) Min	V <sub>EB0</sub> (V) Min	I <sub>CB0</sub> (mA) Max	V <sub>CB</sub> (V) Max	h <sub>FE</sub> Min	I <sub>C</sub> @ (mA) Max	V <sub>CE</sub> & V <sub>CE</sub> (V) (V)	V <sub>CE(SAT)</sub> (V) Max	V <sub>BE(SAT)</sub> (V) Min	I <sub>C</sub> (mA) Max	C <sub>0p/C<sub>re</sub></sub> (pF) Min	f <sub>T</sub> (MHz) Min	I <sub>C</sub> (mA) Max	NF (dB) @ Max	Freq (MHz) Max	Process No.	
MPS3563	TO-92 (72)		20		5	15	25	2	10				2.5	700	10			43	
MPS6507	TO-92 (72)	30*	20		5	15	25	2	10				2.5	700	10			43	
MPS6511	TO-92 (72)	30*	20		50	15	25	10	10				2.5	700	10			43	
MPS6539	TO-92 (71)	20	20		50	15	20	4	10				0.7	500	4	4.5	100	42	
MPS6540	TO-92 (71)	30	30	4	100	25	25	2	10	0.5		10	0.65	350	2			49	
MPS6541	TO-92 (72)	30*	20	4	50	15	25	4	10				1.7	600	1500	4		43	
MPS6542	TO-92 (76)	30*	20		50	15	25	2	10				1.5	700	10			47	
MPS6543	TO-92 (76)	35	20	3	100	25	25	4	10	0.35	0.95	10	1	750	4			47	
MPS6544	TO-92 (71)	60	45	4	500	35	20	30	10	0.5		30	0.65					49	
MPS6546	TO-92 (76)	35	25	3	100	25	20	2	10	0.35		10	0.45	600	2			47	
MPS6547	TO-92 (76)	35	25	3	100	25	20	2	5	0.35		10	0.35	600	2			47	
MPS6548	TO-92 (71)	30	25	3	100	25	25	4	10	0.5	0.95	4	0.7	650	4			42	
MPS6567	TO-92 (71)		40	5	500	35	25	10	5	0.5		10	0.7					49	
MPS6568A	TO-92 (71)	20	20	3	50	10	20	200	4	0.3	0.96	10	0.65	375	800	4	3.3	200	44
MPS6569	TO-92 (71)	20	20	3	50	10	20	200	4	3	0.96	10	0.25	300	800	4	6	45	44
MPS6570	TO-92 (71)	20	20	3	50	10	20	200	4	3	0.96	10	0.25	300	800	4	6	45	44
MRF501	TO-72	25	15	3.5	50	1	30	250	1	6				600	5			42	
MRF502	TO-72	35	15	3.5	20	1	40	170	1	6				800	5			42	
NSC460	TO-92 (74)	30	30	5	500	18	35	200	2	1.1		10	3.5			6.5	1	46	
NSC461	TO-92 (74)	30	30	5	500	18	35	200	2	1.1		10	3.5					46	

Same as PN3563, see page 1-10 for explanation

# NPN Transistors

## RF AMPS AND OSCILLATORS (Continued)

Type No.	Case Style	V <sub>CE</sub> * V <sub>CB0</sub> (V) Min	V <sub>CE0</sub> (V) Min	V <sub>EB0</sub> (V) Min	I <sub>CB0</sub> (mA) Max	V <sub>CB</sub> (V) Max	h <sub>FE</sub> Min	h <sub>FE</sub> Max	I <sub>C</sub> (mA) Max	V <sub>CE(SAT)</sub> (V) Max	V <sub>BE(SAT)</sub> (V) Min	I <sub>C</sub> (mA) Max	C <sub>ob</sub> /C <sub>re</sub> (pF) Min	C <sub>ob</sub> /C <sub>re</sub> (pF) Max	f <sub>T</sub> (MHz) Min	f <sub>T</sub> (MHz) Max	I <sub>C</sub> (mA) Max	NF (dB) @ (MHz) Max	Process No.
PE3100	TO-92 (76)	30*	30	3	200	30	30	225	5				0.8		500		5		47
PE5025	TO-92 (72)	30	30	3	50	30	20	100	10	0.6		20	0.6	1	300	700	10		46
PE5029	TO-92 (76)	30	30	3	200	30	30	225	5				0.4		500		5	6 45	47
PE5030B	TO-92 (76)	45	40	4.5	100	30	45	150	7	3		20	0.25	0.4	600		7		47
PE5031	TO-92 (76)	40	30	4	100	30	30	180	5	1		10	0.4		500		5	4.5 200	47
PN918	TO-92 (72)	30	15	3	10	15	20	3	1	0.4		10	1.7		600		4	6 60	43
PN3563	TO-92 (72)	30	15	2	50	15	20	200	8				1.7		600	1500	8		43
PN3564	TO-92 (72)	30	15	4	50	15	20	500	15	0.3		20	3.5		400	1200	15		43
PN5130	TO-92 (72)	30	12	1	50	10	15	250	8	0.6		10	1.7		450		8		43
PN5179	TO-92 (71)	20	15	2.5	2	15	25	250	3	0.4		10	1.0		900	2000	5	4.5 200	42
SE5020	TO-72	20	20	3	50	10	20	200	4	3.0		10	0.25	0.5	375	800	4	3.3 200	44
SE5021	TO-72	20	20	3	50	10	20	200	4	3.0		10	0.25	0.5	375	800	4	4 200	44
SE5022	TO-72	20	20	3	50	10	20	200	4	3.0		10	0.25	0.5	300	800	4		44
SE5023	TO-72	20	20	3	50	10	20	200	4	3.0		10	0.25	0.5	300	800	4	6 45	44
SE5024	TO-72	20	20	3	50	10	20	200	4	3.0		10	0.25	0.5	300	800	4	6 45	44
SE5050	TO-72	20	20	3	50	10	20	200	4	3.0		10	0.25	0.5	300		4	4 100	44
SE5051	TO-72	20	20	3	50	10	20	200	4	3.0		10	0.25	0.5	300		4	4 100	44
SE5052	TO-72	20	20	3	50	10				3.0		10			375		4	4 200	44
SE5055	TO-72	20	20	3	50	20	20	220	2	2.75		10	0.22		300		2	5 45	44
TI586	TO-92 (78)	30	30		100	15	40	200	4	0.5		15	0.45		500		4	5 200	47
TI587	TO-92 (78)	45	45		100	15	30	150	12	0.5		15	0.45		500		12		47



LOW LEVEL AMPS

Type No.	Case Style	V <sub>CB0</sub> (V)		V <sub>CEO</sub> (V)	V <sub>EB0</sub> (V)	I <sub>CB0</sub> (mA)	V <sub>CB</sub> (V)	h <sub>FE</sub> @ I <sub>C</sub> & V <sub>CE</sub>		V <sub>CE(SAT)</sub> & V <sub>BE(SAT)</sub>		I <sub>C</sub> (mA)	f <sub>T</sub> (MHz)	NF (dB) @ Max	Freq (kHz)	Process No.					
		Min	Max					Min	Max	Min	Max						Min	Max	Min	Max	
2N760	TO-18	45	45	8	30	200	30	76	300	1	5	1.0	1.1	10	8	50	1.0	07			
2N760A	TO-18	60	60	8	30	100	30	76	333	1	5	1.0	1.1	10	8	50	1.0	07			
2N929	TO-18	45	45	5	45	10	45	40	350	10	5	1.0	0.6	1.0	8	30	0.5	4	15.7	07	
2N929 J, JTX	TO-18	60	45	6	45	10	45	60	350	10	5	1.0	0.6	1.0	8	45	180	0.5	5	100 Hz	07
2N929A	TO-18	60	45	6	45	2	45	40	120	10	5	0.5	0.7	0.9	6	45	0.5	4	10	07	
2N930	TO-18	45	45	5	45	10	45	60	350	10	5	1.0	0.6	1.0	8	30	0.5	3	15.7	07	
2N930 J, JTX	TO-18	60	45	6	45	10	45	150	600	10	5	1.0	0.6	1.0	8	45	180	0.5	5	100 Hz	07
2N930A	TO-18	60	45	6	45	2	45	100	300	10	5	0.5	0.7	0.9	6	45	0.5	3	10	07	
2N981	TO-18	80	80	8	30	1	30	36	100	1	5	3.0	0.6	1.0	5	50	1.0	3	10	07	
2N2484	TO-18	60	60	6	45	10	45	250	600	10	5	0.35	0.6	1.0	10	15	0.05	10	20 Hz	07	
2N2484 J, JTX, JTXV	TO-18	60	60	6	45	10	45	200	500	5	5	1	0.6	1.0	10	15	0.05	3	200 Hz	07	
2N2509	TO-18	125	80	7	100	5	100	175	100	5	5	1	0.6	1.0	5	60	210	0.5	7.5	100 Hz	07
2N2510	TO-18	100	65	7	80	5	80	100	500	10	5	1.0	0.9	5	6	45	5	7	1	07	
	TO-18							60	500	10	5	1.0	0.9	5	6	45	5	4	1	07	



# NPN Transistors



## LOW LEVEL AMPS (Continued)

Type No.	Case Style	V <sub>CB0</sub> (V)		V <sub>CE0</sub> (V)		V <sub>EB0</sub> (V)		I <sub>CB0</sub> (mA)		V <sub>CB</sub> (V)		h <sub>FE</sub>		I <sub>C</sub> & V <sub>CE</sub> (V)		V <sub>CE(SAT)</sub> & V <sub>BE(SAT)</sub> (V)		I <sub>C</sub> (mA)		C <sub>ob</sub> (pF)		f <sub>T</sub> (MHz)		I <sub>C</sub> (mA)		NF (dB) @		Process No.		
		Min	Max	Min	Max	Min	Max	Min	Max	Min	Max	Min	Max	Min	Max	Min	Max	Min	Max	Min	Max	Min	Max	Min	Max	Min	Max		Min	Max
2N2511	TO-18	80		50		7		5		60		240	750	10	5	1.0	0.9	5		6		45		5		4	1		07	
2N2504	TO-46	60		45		6		2		45		150	600	1	5	0.5	0.7	10		6		45		0.5		3	10		07	
2N2586	TO-18	60		45		6		2		45		150	360	5	5	0.5	0.7	10		7		45		0.5		3	1		07	
2N3117	TO-18	60		60		6		10		45		400	300	1	5	0.35		1		4.5		60		0.5		4	20 Hz		07	
2N3246	TO-18	60		40		10		1		40		400	800	1	5	0.5	0.7	5		5		60		180	1	2	15		07	
2N3565	TO-92 (72)	Same as PN3565, see page 1-14 for explanation																									07			
2N3707	TO-92 (74)	30		30		6		100		20		100	400	100	5	1.0		10								5	15.7		07	
2N3708	TO-92 (74)	30		30		6		100		20		45	660	1	5	1.0		10												
2N3709	TO-92 (74)			30				100		20		45	165	1	5	1.0		10												07
2N3710	TO-92 (74)	30		30		6		100		20		90	330	1	5	1.0		10												07
2N3711	TO-92 (74)	30		30		6		100		20		180	660	1	5	1.0		10												07
2N3858A	TO-92 (74)	60		60		6		500		18		60	120	10	1					4		90		250	2					07
2N3859A	TO-92 (74)	60		60		6		500		18		100	200	10	1					4		90		250	2					07
2N3877	TO-92 (74)	70		70		4		500		70		20	250	2	4.5	0.5	0.9	10												07



LOW LEVEL AMPS (Continued)

Type No.	Case Style	VCBO (V) Min	VCEO (V) Min	VEBO (V) Min	ICBO (nA) Max	VCB (V)	hFE Min	IC (mA) Max	VCE (V) Max	VBE(SAT) (V) Min	IC (mA) Max	Cob (pF) Max	fT (MHz) Max	IC (mA) Min	NF (dB) @ Max	Freq (kHz)	Process No.	
2N3877A	TO-92 (74)	85	85	4	500	70	20	2	4.5	0.5	10						07	
2N3900	TO-92 (74)	18	18	5	100	18	250	500	4.5			12					07	
2N3900A	TO-92 (74)	18	18	5	100	18	250	500	4.5			12			5	15.7	07	
2N3901	TO-92 (74)	18	18	5	100	15	350	700	4.5						5	15.7	07	
2N4286	TO-92 (74)	30	25	6	50	25	150	600	5	0.35	1	6	40	1			07	
2N4287	TO-92 (74)	45	45	7	10	30	150	600	5	0.35	1	6	40	1	5	15.7	07	
2N4384	TO-18	40	30	5	10	30	150	10	5	0.2	10	8	30	120	0.5	2	15.7	07
2N4386	TO-18	40	30	5	10	30	120	10	5	0.2	10	8	30	120	0.5	3	15.7	07
2N4409	TO-92 (72)	80	50	5	10	60	40	500	5		10	12	60	300	10		07	
2N4410	TO-92 (72)	120	80	5	10	100	60	400	1	0.2	1	12	60	300	10		07	
2N4966	TO-92 (72)	Same as 2N5209, see page 1-14 for explanation																07
2N4967	TO-92 (72)	Same as 2N5210, see page 1-14 for explanation																07
2N4968	TO-92 (72)	Same as 2N5209, see page 1-14 for explanation																07
2N5088	TO-92 (72)	35	30		50	20	300	10	5	0.5	10	4			3	15.7	07	
2N5089	TO-92 (72)	30	25		50	15	350	1	5								07	
2N5133	TO-92 (72)						300	900	100								07	
							400	1200	100	0.5	10	4			2	15.7	07	
							400	450	1								07	
							400	1200	100								07	



## LOW LEVEL AMPS (Continued)

Type No.	Case Style	V <sub>CEO</sub> (V)		V <sub>BE0</sub> (V)		I <sub>CEO</sub> (mA) @ V <sub>CB</sub>	h <sub>FE</sub>		I <sub>C</sub> & V <sub>CE</sub>		V <sub>CE(SAT)</sub> & V <sub>BE(SAT)</sub>		I <sub>C</sub>		C <sub>ob</sub> (pF) Max	f <sub>T</sub> (MHz)		I <sub>C</sub> (mA) @ NF (dB) Max	Freq (kHz)	Process No.
		Min	Max	Min	Max		Min	Max	Min	Max	Min	Max	Min	Max		Min	Max			
2N5209	TO-92 (72)	50	50	35	50	50	150	150	10	5	0.7	10	4	30	0.5	4	1	07		
2N5210	TO-92 (72)	50	50	35	50	50	250	250	10	5	0.7	10	4	30	0.5	3	1	07		
2N5232	TO-92 (74)	50	50	50	50	30	250	500	2	5	0.125	10	4					07		
2N5232A	TO-92 (74)	50	50	50	50	30	250	500	2	5	0.125	10	4					07		
EN930	TO-92 (72)	Same as PN930, see below for explanation																		
EN2484	TO-92 (72)	Same as PN2484, see below for explanation																		
MPSA09	TO-92 (72)	50	50	25	100	100	100	600	100	5	0.9	10	5	600	0.5			07		
MPS3707	TO-92 (72)	30	30	20	100	100	400	100	5	1.0	1.0	10				5	15.7	07		
MPS3708	TO-92 (72)	30	30	20	100	100	45	660	1	5	1.0	10						07		
MPS3709	TO-92 (72)	30	30	20	100	100	45	165	1	5	1.0	10						07		
MPS3710	TO-92 (72)	30	30	20	100	100	90	330	1	5	1.0	10						07		
MPS3711	TO-92 (72)	30	30	20	100	100	180	660	1	5	1.0	10						07		
MPS6571	TO-92 (72)	25	20	3	50	20	250	1000	100	5	0.5	10	4.5	50	0.5			07		
PE4010	TO-92 (72)	30	25	6	200	5	200	1000	1	10	0.35	1	4	20	0.05	3	1	07		
PN930	TO-92 (72)	45	45	5	10	45	600	10	5	1.0	0.6	1.0	10	8	0.5	3	15.7	07		
PN2484	TO-92 (72)	60	60	6	10	45	800	10	5	0.35	10	6						07		
PN3565	TO-92 (72)	30	25	6	50	25	150	600	1	10	0.35	1	4	40	240	1		07		
PN5133	TO-92 (72)	20	18	3	50	15	60	1000	1	5	0.4	1	5	40	240	1		07		





### GENERAL PURPOSE AMPS AND SWITCHES

Type No.	Case Style	VCBO (V) Min	VCEO (V) Min	VEBO (V) Min	ICBO (nA) @ VCB Max	hFE Min	hFE Max @ IC & VCE (1 kHz)	VCE(SAT) (V) Max	VBE(SAT) (V) Min & Max	IC (mA) @ VCE Max	Cob (pF) Max	fT (MHz) Min	fT (MHz) Max	t <sub>off</sub> (ns) Max	NF (dB) Max	Test Condition	Process No.
2N697	TO-5	60	45	5	1 μA	40	120	1.5	1.3	150	35	50	50				20
2N718	TO-18	60	30	5	1 μA	40	120	1.5	1.3	150	35	50	15				20
2N718A	TO-18	75		7	10	20	40	1.5	1.3	150	25	60	50		12	1	20
						40	120										
						35	10										
						20	100 μA										
2N915	TO-18	70	50	5	10	50	200	1.0	0.9	10	3.5	250	10				23
2N916	TO-18	45	25	5	10	50	200	0.5	0.9	10	6	300	10				23
2N956	TO-18	75	35	7	10	40	300	1.5	1.3	150	25	70	50		8	1	20
						100	300										
						75	10										
						35	100 μA										
						20	10 μA										
2N1420	TO-5	60	30	5	1 μA	100	300	1.5	1.3	150	35	50	50				20
2N1566	TO-5	80	60	5	1 μA	80	200	1.0		10	10	60	5				20
2N1613	TO-5	75	35	7	10	20	500	1.5	1.3	150	25	60	50		12	1	20
						40	120										
						35	10										
						20	100 μA										
2N1711	TO-5	75	35	7	10	40	300	1.5	1.3	150	25	70	50		8	1	20
						100	300										
						75	10										
						35	100 μA										
						20	10 μA										
2N2218	TO-5	60	30	5	10	20	500	0.4	1.3	150	8	250	20				20
						20	150										
						40	120		2.6	500							
						35	10										
						25	1										
						20	100 μA										
2N2218 J, JTX, JTXV	TO-5	60	30	5	10	20	500	0.4	0.6	1.3	8	250	20	250		2	20
						40	120										
						35	10		2.6	500							
						25	1										
						20	100 μA										

#### TEST CONDITIONS:

(1) IC = 300 μA, VCE = 10V, f = 1kHz. (2) IC = 150mA, VCC = 30V, IB<sup>1</sup> = IB<sup>2</sup> = 15mA. (3) IC = 100 μA, VCE = 10V, f = 1kHz. (4) IC = 300mA, VCC = 25V, IB<sup>1</sup> = IB<sup>2</sup> = 30mA. (5) IC = 100 μA, VCE = 4.5V, f = 15.7kHz. (6) IC = 10mA, VCC = 3V, IB<sup>1</sup> = IB<sup>2</sup> = 1mA. (7) IC = 100 μA, VCE = 5V, f = 15.7kHz. (8) IC = 250 μA, VCE = 5V, f = 10Hz-15.7kHz. (9) IC = 3mA, VCE = 10V, f = 1MHz. (10) IC = 10 μA, VCE = 5V, f = 15.7kHz.





## GENERAL PURPOSE AMPS AND SWITCHES (Continued)

Type No.	Case Style	V <sub>CE0</sub> (V) Min	V <sub>CE0</sub> (V) Max	V <sub>BE0</sub> (V) Min	I <sub>CBO</sub> (nA) @ V <sub>CB</sub> (V) Max	h <sub>FE</sub> Min Max @ I <sub>C</sub> & V <sub>CE</sub> (V)	V <sub>CE(SAT)</sub> (V) & V <sub>BE(SAT)</sub> (V) @ I <sub>C</sub> (mA) Max Min Max	I <sub>C</sub> (mA) @ I <sub>C</sub> (mA) Max	C <sub>ob</sub> (pF) Max	f <sub>T</sub> (MHz) Min Max	I <sub>C</sub> (mA) Max	t <sub>off</sub> (ns) Max	NF (dB) Max	Test Condition	Process No.
2N2218A	TO-5	75	40	6	10	25 20 40 35 25 20 500 150 10 10 10 100 μA	0.3 0.6 1.2	150 20	8	250	20	285		2	20
2N2218A J, JTX, JTXV	TO-5	75	50	6	10	20 40 40 35 30 500 150 10 10 10 100 μA	0.3 0.6 1.2	150 20	8	250	20	300		2	20
2N2219	TO-5	60	30	5	10	30 50 100 75 50 35 500 150 10 10 10 100 μA	0.4 1.3 2.6	150 20	8	250	20				20
2N2219 J, JTX, JTXV	TO-5	60	30	5	10	30 100 75 50 35 500 150 10 10 10 100 μA	0.4 0.6 1.2	150 20	8	250	20	250		2	20
2N2219A	TO-5	75	40	6	10	40 50 100 75 50 35 500 150 10 10 10 100 μA	0.6 1.2 2	150 20	8	300	20	285		2	20
2N2219A J, JTX, JTXV	TO-5	75	50	6	10	30 100 100 1 100 μA	0.3 0.6 1.2	150 20	8	250	20	300		2	20
2N2221	TO-18	60	30	5	10	20 20 40 35 25 20 500 150 10 10 10 100 μA	0.4 1.3 2.6	150 20	8	250	20				20



GENERAL PURPOSE AMPS AND SWITCHES (Continued)

Type No.	Case Style	V <sub>CB0</sub> (V) Min	V <sub>CE0</sub> (V) Min	V <sub>EB0</sub> (V) Min	I <sub>CB0</sub> (mA) Max	V <sub>CB</sub> (V) @ I <sub>C</sub> & V <sub>CE</sub>	h <sub>FE</sub> Min Max	I <sub>C</sub> (mA) @ 100 μA	V <sub>CE(SAT)</sub> (V) Max	V <sub>BE(SAT)</sub> (V) Min Max	I <sub>C</sub> (mA) @ I <sub>C</sub> & V <sub>CE</sub>	C <sub>ob</sub> (pF) Max	f <sub>T</sub> (MHz) Min Max	I <sub>C</sub> (mA) @ I <sub>C</sub> & V <sub>CE</sub>	t <sub>off</sub> (ns) Max	NF (dB) Max	Test Condition	Process No.
2N2221 J, JTX, JTXV	TO-18	60	30	5	10	50	20 40 35 25 20	500 150 10 1 100 μA	0.4 1.6	0.6 2.6	1.3 500	8	250	20	250		2	20
2N2221A	TO-18	75	40	6	10	60	25 40 35 25 20	500 150 10 1 100 μA	0.3 1.0	0.6 2.0	1.2 500	8	250	20	285		2	20
2N2221A J, JTX, JTXV	TO-18	75	50	6	10	60	20 40 35 30	500 150 10 100 μA	0.3 1.0	0.6 2.0	1.2 500	8	250	20	300		2	20
2N2222	TO-18	60	30	5	10	50	30 50 100 75 50 35	500 150 10 1 100 μA	0.4 1.6	1.3 2.6	150 500	8	250	20				20
2N2222 J, JTX, JTXV	TO-18	60	30	5	10	50	30 100 75 50 35	500 150 10 1 100 μA	0.4 1.6	1.3 2.6	150 500	8	250	20			2	20
2N222A	TO-18	75	40	6	10	60	40 50 100 75 50 35	500 150 10 1 100 μA	0.3 1	0.6 2	1.2 500	8	250	20	285	4	2/3	20
2N222A J, JTX, JTXV	TO-18	75	50	6	10	60	30 100 100 75 50	500 150 10 1 100 μA	0.3 1	0.6 2	1.2 500	8	250	20	300		2	20
2N2712	TO-92 (74)	18	18	5	500	18	75 225	2 4.5				12	80 300	2				27

TEST CONDITIONS:

(1) I<sub>C</sub> = 300 μA, V<sub>CE</sub> = 10V, f = 1kHz. (2) I<sub>C</sub> = 150mA, V<sub>CC</sub> = 30V, I<sub>B</sub><sup>1</sup> = I<sub>B</sub><sup>2</sup> = 15mA. (3) I<sub>C</sub> = 100 μA, V<sub>CE</sub> = 10V, f = 1kHz. (4) I<sub>C</sub> = 300mA, V<sub>CC</sub> = 25V, I<sub>B</sub><sup>1</sup> = I<sub>B</sub><sup>2</sup> = 30mA. (5) I<sub>C</sub> = 100 μA, V<sub>CE</sub> = 4.5V, f = 15.7kHz. (6) I<sub>C</sub> = 10mA, V<sub>CC</sub> = 3V, I<sub>B</sub><sup>1</sup> = I<sub>B</sub><sup>2</sup> = 1mA. (7) I<sub>C</sub> = 100 μA, V<sub>CE</sub> = 5V, f = 15.7kHz. (8) I<sub>C</sub> = 250 μA, V<sub>CE</sub> = 5V, f = 10Hz-15.7kHz. (9) I<sub>C</sub> = 3mA, V<sub>CE</sub> = 10V, f = 1MHz. (10) I<sub>C</sub> = 10 μA, V<sub>CE</sub> = 5V, f = 15.7kHz.



# NPN Transistors



## GENERAL PURPOSE AMPS AND SWITCHES (Continued)

Type No.	Case Style	V <sub>CE0</sub> (V) Min	V <sub>CE0</sub> (V) Min	V <sub>EB0</sub> (V) Min	I <sub>CB0</sub> (nA) Max	V <sub>CB</sub> (V)	h <sub>FE</sub> Min	h <sub>FE</sub> Max	I <sub>C</sub> @ (mA)	V <sub>CE(SAT)</sub> (V) Max	V <sub>BE(SAT)</sub> (V) Min	I <sub>C</sub> @ (mA) Max	C <sub>ob</sub> (pF) Max	f <sub>T</sub> (MHz) Min	I <sub>C</sub> @ (mA) Max	t <sub>off</sub> (ns) Max	NF (dB) Max	Test Condition	Process No.
2N2714	TO-92 (74)	18	5	18	500	18	75	225	2	0.3	0.6	1.2	50						27
2N2923	TO-92 (74)	25	5	25	100	25	90	180	2				10						04
2N2924	TO-92 (74)	25	5	25	100	25	150	300	2				10						04
2N2925	TO-92 (74)	25	5	25	100	25	235	470	2				10						04
2N2926	TO-92 (74)	18	5	18	500	18	35	470	2				10						04
2N3115	TO-18	60	5	25	25	50	40	120	150	0.5	1.3	150	8	250	20	500		2	20
2N3116	TO-18	60	5	25	25	50	100	300	150	0.5	1.3	150	8	250	20	500		2	20
2N3299	TO-5	60	5	30	10*	50	20	500	10	0.22	1.1	150	8	250	50	150		4	20
							20	150	1										
							40	120	150	0.6	1.5	500							
							35	10	10										
							25	1	10										
							20	100	μA	10									
2N3300	TO-5	60	5	30	10*	50	50	500	10	0.22	1.1	150	8	250	50	150		4	20
							50	150	1										
							100	300	150	0.6	1.5	500							
							75	10	10										
							50	1	10										
							35	100	μA	10									
2N3301	TO-18	60	5	30	10*	50	20	500	10	0.22	1.1	150	8	250	50	150		4	20
							20	150	1										
							40	120	150	0.6	1.5	500							
							35	10	10										
							25	1	10										
							20	100	μA	10									
2N3302	TO-18	60	5	30	10*	50	50	500	10	0.22	1.1	150	8	250	50	150		4	20
							50	150	1										
							100	300	150	0.6	1.5	500							
							75	10	10										
							50	1	10										
							35	100	μA	10									
2N3390	TO-92 (74)	25	5	25	100	18	400	800	2				10						04
2N3391	TO-92 (74)	25	5	25	100	18	250	500	2				10						04



GENERAL PURPOSE AMPS AND SWITCHES (Continued)

Type No.	Case Style	V <sub>CS0</sub> (V)		V <sub>CE0</sub> (V)		V <sub>EB0</sub> (V)		I <sub>CS0</sub> (mA)		V <sub>CB</sub> (V)		h <sub>FE</sub>		I <sub>C</sub> & V <sub>CE</sub>		V <sub>CE(SAT)</sub> & V <sub>BE(SAT)</sub>		I <sub>C</sub>		f <sub>T</sub> (MHz)		C <sub>ob</sub> (pF)		NF (dB) Max	Test Condition	Process No.	
		Min	Max	Min	Max	Min	Max	Min	Max	Min	Max	Min	Max	Min	Max	Min	Max	Min	Max	Min	Max	Min	Max				Min
2N3381	TO-92 (74)	25	25	5	18	5	100	18	250	500	2	4.5												10	5	04	
2N3382	TO-92 (74)	25	25	5	18	5	100	18	150	300	2	4.5												10		04	
2N3383	TO-92 (74)	25	25	5	18	5	100	18	90	180	2	4.5												10		04	
2N3384	TO-92 (74)	25	25	5	18	5	100	18	55	110	2	4.5												10		0.4	
2N3385	TO-92 (74)	25	25	5	18	5	100	18	150	500	2	4.5												10		04	
2N3386	TO-92 (74)	25	25	5	18	5	100	18	90	500	2	4.5												10		04	
2N3387	TO-92 (74)	25	25	5	18	5	100	18	55	500	2	4.5												10		04	
2N3388	TO-92 (74)	25	25	5	18	5	100	18	55	800	2	4.5												10		04	
2N3414	TO-92 (74)	25	25	5	25	5	100	25	75	225	2	4.5															19
2N3415	TO-92 (74)	25	25	5	25	5	100	25	180	540	2	4.5															04
2N3416	TO-92 (74)	50	50	5	25	5	100	25	75	225	2	4.5															04
2N3417	TO-92 (74)	50	50	5	25	5	100	25	180	540	2	4.5															04
2N3641	TO-92 (72)	Same as PN3641, see page 1-22 for explanation																								19	
2N3642	TO-92 (72)	Same as PN3642, see page 1-22 for explanation																								19	
2N3643	TO-92 (72)	Same as PN3643, see page 1-22 for explanation																								19	
2N3678	TO-5	75	55	6	60	25	500	10	20	150	1	10	0.4	0.6	1.2	150											20

TEST CONDITIONS:

(1) I<sub>C</sub> = 300 μA, V<sub>CE</sub> = 10V, f = 1kHz. (2) I<sub>C</sub> = 150mA, V<sub>CC</sub> = 30V, I<sub>B</sub><sup>1</sup> = I<sub>B</sub><sup>2</sup> = 15mA. (3) I<sub>C</sub> = 100 μA, V<sub>CE</sub> = 10V, f = 1kHz. (4) I<sub>C</sub> = 300mA, V<sub>CC</sub> = 25V, I<sub>B</sub><sup>1</sup> = I<sub>B</sub><sup>2</sup> = 30mA. (5) I<sub>C</sub> = 100 μA, V<sub>CE</sub> = 4.5V, f = 15.7kHz. (6) I<sub>C</sub> = 10mA, V<sub>CC</sub> = 3V, I<sub>B</sub><sup>1</sup> = I<sub>B</sub><sup>2</sup> = 1mA. (7) I<sub>C</sub> = 100 μA, V<sub>CE</sub> = 5V, f = 15.7kHz. (8) I<sub>C</sub> = 250 μA, V<sub>CE</sub> = 5V, f = 10Hz-15.7kHz. (9) I<sub>C</sub> = 3mA, V<sub>CE</sub> = 10V, f = 1MHz. (10) I<sub>C</sub> = 10 μA, V<sub>CE</sub> = 5V, f = 15.7kHz.



# NPN Transistors



## GENERAL PURPOSE AMPS AND SWITCHES (Continued)

Type No.	Case Style	V <sub>CEO</sub> (V)		V <sub>EB0</sub> (V)		I <sub>CB0</sub> (mA)		V <sub>CB</sub> (V)		h <sub>FE</sub>		I <sub>C</sub> & V <sub>CE</sub>		V <sub>CE(SAT)</sub> & V <sub>BE(SAT)</sub>		I <sub>C</sub> @ (mA)		C <sub>ob</sub> (pF)		f <sub>T</sub> (MHz)		t <sub>off</sub> (ns)		NF (dB)		Test Condition	Process No.		
		Min	Max	Min	Max	Min	Max	Min	Max	Min	Max	Min	Max	Min	Max	Min	Max	Min	Max	Min	Max	Min	Max	Min	Max				
2N3691	TO-92 (72)	Same as PN3691, see page 1-22 for explanation																											
2N3692	TO-92 (72)	Same as PN3692, see page 1-22 for explanation																											
2N3693	TO-92 (72)	Same as MPS3693, see page 1-24 for explanation																											
2N3694	TO-92 (72)	Same as PN3694, see page 1-22 for explanation																											
2N3704	TO-92 (74)	50	30	5	100	20	100	300	50	2	0.6	100	100	50	12	100	100	50	13										
2N3705	TO-92 (74)	50	30	5	100	20	50	150	50	2	0.8	100	100	50	12	100	100	50	13										
2N3706	TO-92 (74)	40	20	5	100	20	30	600	50	2	1.0	100	100	50	12	100	100	50	13										
2N3721	TO-92 (74)	18	18	5	500	18	60	660	2	10	12								27										
2N3793	TO-92 (74)	40	20	5	500	15	20	100	10	10	0.4	10	100	10	10	100	600	10	13										
2N3794	TO-92 (74)	40	20	5	500	15	100	100	10	10	0.4	10	100	10	10	100	600	10	13										
2N3827	TO-92 (74)	60	45	4	100	30	100	400	10	10	3.5								27										
2N3858	TO-92 (74)	30	30	4	500	18	60	120	2	4.5	4	90	250	2					27										
2N3859	TO-92 (74)	30	30	4	500	18	100	200	2	4.5	4	90	250	2					27										
2N3860	TO-92 (74)	30	30	4	500	18	150	300	2	4.5	4	90	250	2					27										
2N3903	TO-92 (72)	60	40	6			15	100	1	1	0.2	0.6	0.85	10	4	250	10	225	6	6/7	23								
2N3904	TO-92 (72)	60	40	6	30		30	60	50	1	0.3	0.95	50														6/7	23	



GENERAL PURPOSE AMPS AND SWITCHES (Continued)

Type No.	Case Style	V <sub>CEO</sub> (V) Min	V <sub>CEO</sub> (V) Max	V <sub>BE(SAT)</sub> (V) Min	V <sub>BE(SAT)</sub> (V) Max	V <sub>CE(SAT)</sub> (V) Min	V <sub>CE(SAT)</sub> (V) Max	I <sub>C</sub> (mA) Min	I <sub>C</sub> (mA) Max	I <sub>CB</sub> (mA) Max	V <sub>CB</sub> (V) Min	V <sub>CB</sub> (V) Max	h <sub>FE</sub>	I <sub>C</sub> (mA) Min	I <sub>C</sub> (mA) Max	V <sub>BE(SAT)</sub> (V) Min	V <sub>BE(SAT)</sub> (V) Max	I <sub>C</sub> (mA) Min	I <sub>C</sub> (mA) Max	C <sub>ob</sub> (pF) Max	f <sub>T</sub> (MHz)		t <sub>off</sub> (ns) Max	NF (dB) Max	Test Condition	Process No.
																					Min	Max				
2N3946	TO-18	60	40	6		0.2	0.6	50	10				20	50	10	0.2	0.6	10	10	4	250	375	5	6/7	23	
2N3947	TO-18	60	40	6		0.2	0.6	50	10				40	50	10	0.2	0.6	10	10	4	300	450	5	6/7	23	
2N4123	TO-92 (72)	40	30	5	20	0.3	0.3	50	50	50	20	20	25	50	50	0.3	0.95	10	10	4	250	6	7	23		
2N4124	TO-92 (72)	30	25	5	20	0.3	0.3	50	50	50	20	20	60	50	50	0.3	0.95	10	10	4	300	5	7	23		
2N4140	TO-92 (72)	Same as PN4140, see page 1-22 for explanation						120	360	2	1													19		
2N4141	TO-92 (72)	Same as PN4141, see page 1-22 for explanation																						19		
2N4400	TO-92 (72)	60	40	6		0.4	0.75	500	150				20	500	2	0.4	0.75	150	150	6.5	200	255	2	13		
2N4401	TO-92 (72)	60	40	6		0.4	0.75	500	150				40	500	2	0.4	0.75	150	150	6.5	250	255	2	13		
PN2221	TO-92 (72)	60	30	5	10	0.4	1.3	500	10				20	500	10	0.4	1.3	150	20	8	250			19		
PN2221A	TO-92 (72)	75	40	6	10	0.3	0.6	500	10				20	500	10	0.3	0.6	150	20	8	250	285	2	19		

TEST CONDITIONS:

(1) I<sub>C</sub> = 300 μA, V<sub>CE</sub> = 10V, f = 1kHz. (2) I<sub>C</sub> = 150mA, V<sub>CC</sub> = 30V, I<sub>B</sub><sup>1</sup> = I<sub>B</sub><sup>2</sup> = 15mA. (3) I<sub>C</sub> = 100 μA, V<sub>CE</sub> = 10V, f = 1kHz. (4) I<sub>C</sub> = 300mA, V<sub>CC</sub> = 25V, I<sub>B</sub><sup>1</sup> = I<sub>B</sub><sup>2</sup> = 30mA. (5) I<sub>C</sub> = 100 μA, V<sub>CE</sub> = 4.5V, f = 15.7kHz. (6) I<sub>C</sub> = 10mA, V<sub>CC</sub> = 3V, I<sub>B</sub><sup>1</sup> = I<sub>B</sub><sup>2</sup> = 1mA. (7) I<sub>C</sub> = 100 μA, V<sub>CE</sub> = 5V, f = 15.7kHz. (8) I<sub>C</sub> = 250 μA, V<sub>CE</sub> = 5V, f = 10Hz-15.7kHz. (9) I<sub>C</sub> = 3mA, V<sub>CE</sub> = 10V, f = 1MHz. (10) I<sub>C</sub> = 10 μA, V<sub>CE</sub> = 5V, f = 15.7kHz.

## GENERAL PURPOSE AMPS AND SWITCHES (Continued)

Type No.	Case Style	V <sub>CEO</sub> (V) Min	V <sub>CEO</sub> (V) Min	V <sub>BE0</sub> (V) Min	I <sub>CEO</sub> (mA) Max	V <sub>CB</sub> (V)	h <sub>FE</sub> Min	h <sub>FE</sub> Max	I <sub>C</sub> (mA) Max	V <sub>CE</sub> (V)	V <sub>CE(SAT)</sub> (V) Max	V <sub>BE(SAT)</sub> (V) Min	V <sub>BE(SAT)</sub> (V) Max	I <sub>C</sub> (mA) Max	C <sub>ob</sub> (pF) Max	f <sub>T</sub> (MHz) Min	f <sub>T</sub> (MHz) Max	t <sub>off</sub> (ns) Max	NF (dB) Max	Test Condition	Process No.
PN2222	TO-92 (72)	60	30	5	10	50	30	500	10	10	0.4	1.3	150	8	250	20					19
PN2222A	TO-92 (72)	75	40	6	10	60	40	500	10	10	0.3	0.6	1.2	8	300	20	285			2	19
PN3641	TO-92 (72)	60*	30	5	50*	50	15	500	10	10	0.22		150	8	250	50					19
PN3642	TO-92 (72)	60	45	5	50*	50	15	500	10	10	0.22		150	8	250	50					19
PN3643	TO-92 (72)	60	30	5	50*	50	20	500	10	10	0.22		150	8	250	50					19
PN3691	TO-92 (72)	35	20	4	50	15	40	160	1	1	0.7	0.9	10	3.5	200	500	10				23
PN3692	TO-92 (72)	35	20	4	50	15	100	400	1	1	0.7	0.9	10	3.5	200	500	10				23
PN3694	TO-92 (72)	45	45	4	50	30	100	400	1	1				6	200	10					27
PN4140	TO-92 (72)	60	30	5			20	500	10	10	0.4	1.3	150	8	250	20	310			2	19
PN4141	TO-92 (72)	60	30	5	50	150	30	500	10	10	0.4	1.3	150	8	250	20	310			2	19
PN5127	TO-92 (72)	20	12	3	50	10	15	300	2	10	0.3	1.0	10	3.5	150	2					27
PN5128	TO-92 (72)	15	12	3	50	10	35	350	50	10	0.25	1.1	150	10	200	800	50				19





GENERAL PURPOSE AMPS AND SWITCHES (Continued)

Type No.	Case Style	V <sub>CEO</sub> (V) Min	V <sub>CE0</sub> (V) Min	V <sub>BE0</sub> (V) Min	I <sub>CBO</sub> (nA) @ V <sub>CE</sub> Max	V <sub>CB</sub> (V)	h <sub>FE</sub> Min	h <sub>FE</sub> Max	I <sub>C</sub> (mA) @ V <sub>CE</sub> & V <sub>BE</sub>	V <sub>CE</sub> (SAT) (V) Max	V <sub>BE</sub> (SAT) (V) Min	I <sub>C</sub> (mA) @ V <sub>CE</sub> (SAT) & V <sub>BE</sub> (SAT)	C <sub>ob</sub> (pF) Max	f <sub>T</sub> (MHz) Min	f <sub>T</sub> (MHz) Max	I <sub>C</sub> (mA) @ f <sub>T</sub> Max	t <sub>off</sub> (ns) Max	NF (dB) Max	Test Condition	Process No.
PN5129	TO-92 (72)	15	12	3	50	10	35	350	50	10	10	150	10	200	800	50				19
PN5131	TO-92 (72)	20	15	3	50	10	35	500	10	1	1.0	10	6	100		10				27
PN5132	TO-92 (72)	20	20	3	50	10	30	400	10	10	2.0	10	3.5	200		10				27
PN5135	TO-92 (72)	30	25	4	300	15	50	60*	10	10	1.0	100	25	40	500	30				19
PN5136	TO-92 (72)	30	20	3	100	20	20	400	150	1	0.25	150	35	40	400	50				19
PN5137	TO-92 (72)	30	20	3	100	20	20	400	150	1	0.25	150	35	40	400	50				19
EN2222	TO-92 (72)	Same as PN2222, see page 1-22 for explanation																		
MPSA10	TO-92 (72)		40	4	100	30	40	400	5	10			4	50		5				27
MPSA20	TO-92 (72)		40	4	100	30	40	400	5	10			4	125		5				02
MPSL01	TO-92 (72)	140	120	5	1 μA	40	50	300	10	5	0.2	10	8	60		10				16
MPS2711	TO-92 (72)	18	18	5	500	18	30	90	2	4.5			4							23
MPS2712	TO-92 (72)	18	18	5	500	18	75	225	2	4.5			4							23
MPS2716	TO-92 (72)	18	18	5	500	18	75	225	2	4.5			3.5							23
MPS2923	TO-92 (72)	25	25	5	500	25	90	180	2	10			12							04
MPS2924	TO-92 (72)	25	25	5	500	25	150	300	2	10			12							04
MPS2925	TO-92 (72)	25	25	5	500	25	235	470	2	10			12							04
MPS2926	TO-92 (72)	25	25	5	500	18	35	470	2	10			3.5							04
MPS3392	TO-92 (72)	25	25	5	100	18	150	300	2	4.5			10							04

TEST CONDITIONS:

(1) I<sub>C</sub> = 300 μA, V<sub>CE</sub> = 10V, f = 1kHz. (2) I<sub>C</sub> = 150mA, V<sub>CC</sub> = 30V, I<sub>B</sub><sup>1</sup> = I<sub>B</sub><sup>2</sup> = 15mA. (3) I<sub>C</sub> = 100 μA, V<sub>CE</sub> = 10V, f = 1kHz. (4) I<sub>C</sub> = 300mA, V<sub>CC</sub> = 25V, I<sub>B</sub><sup>1</sup> = I<sub>B</sub><sup>2</sup> = 30mA. (5) I<sub>C</sub> = 100 μA, V<sub>CE</sub> = 4.5V, f = 15.7kHz. (6) I<sub>C</sub> = 10mA, V<sub>CC</sub> = 3V, I<sub>B</sub><sup>1</sup> = I<sub>B</sub><sup>2</sup> = 1mA. (7) I<sub>C</sub> = 100 μA, V<sub>CE</sub> = 5V, f = 15.7kHz. (8) I<sub>C</sub> = 250 μA, V<sub>CE</sub> = 5V, f = 10Hz-15.7kHz. (9) I<sub>C</sub> = 3mA, V<sub>CE</sub> = 10V, f = 1MHz. (10) I<sub>C</sub> = 10 μA, V<sub>CE</sub> = 5V, f = 15.7kHz.



# NPN Transistors



## GENERAL PURPOSE AMPS AND SWITCHES (Continued)

Type No.	Case Style	V <sub>CEO</sub> (V) Min	V <sub>CEO</sub> (V) Max	V <sub>EB0</sub> (V) Min	V <sub>EB0</sub> (V) Max	I <sub>CBO</sub> (mA) Max	V <sub>CB</sub> (V) Max	h <sub>FE</sub> Min	h <sub>FE</sub> Max	I <sub>C</sub> & (mA)	V <sub>CE</sub> (V) Max	V <sub>CE(SAT)</sub> (V) Max	V <sub>BE(SAT)</sub> (V) Min	I <sub>C</sub> (mA) Max	I <sub>C</sub> (mA) @ f <sub>T</sub> Max	f <sub>T</sub> (MHz) Min	f <sub>T</sub> (MHz) Max	t <sub>off</sub> (ns) Max	NF (dB) Max	Test Condition	Process No.
MPS3393	TO-92 (72)	25	18	90	180	2	4.5														04
MPS3394	TO-92 (72)	25	18	55	110	2	4.5														04
MPS3395	TO-92 (72)	25	18	150	500	2	4.5														04
MPS3396	TO-92 (72)	25	18	90	500	2	4.5														04
MPS3397	TO-92 (72)	25	18	55	500	2	4.5														04
MPS3398	TO-92 (72)	25	18	55	800	2	4.5														04
MPS3642	TO-92 (72)	Same as PN3642, see page 1-22 for explanation																			23
MPS3693	TO-92 (72)	45	35	40	160	10	10								200	10			4		27
MPS3694	TO-92 (72)	45	35	100	400	10	10								200	10			4		27
MPS3704	TO-92 (72)	50	20	100	300	50	2	0.6		100	100				100	50					13
MPS3705	TO-92 (72)	50	20	50	150	50	2	0.8		100	100				100	50					13
MPS3706	TO-92 (72)	40	20	30	600	50	2	1.0		100	100				100	50					13
MPS3721	TO-92 (72)			500	18	60	2	10													23
MPS3826	TO-92 (72)	60	45	4	160	10	10								200	800	10				23
MPS3827	TO-92 (72)	60	45	4	400	10	10								200	800	10				23
MPS5172	TO-92 (72)	25	25	100	500	10	10	0.25		10											04
MPS6512	TO-92 (72)	40	30	30	100	10	10	0.5		50											23
MPS6513	TO-92 (72)	40	30	60	100	10	10	0.5		50											23
MPS6514	TO-92 (72)	40	25	4	150	300	2	10		50											23



GENERAL PURPOSE AMPS AND SWITCHES (Continued)

Type No.	Case Style	VCBO (V) Min	VCEO (V) Min	VEBO (V) Min	ICBO (mA) Max	VCB @ (V)	hFE @		VCE & VCE(SAT) (V) Max	VBE(SAT) (V) Min		IC @ (mA) Max	Cob (pF) Max	fT (MHz) Min		toff (ns) Max	NF (dB) Max	Test Condition	Process No.
							Min	Max		Min	Max			Min	Max				
MPS6515	TO-92 (72)	40	25	4	50	30	100	100	0.5	50	50	3.5							23
MPS6520	TO-92 (72)		25	4	50	30	200	400	0.5	50	50	3.5				3		10	04
MPS6521	TO-92 (72)		25	4	50	30	200	600	0.5	50	50	3.5				3		10	04
MPS6530	TO-92 (72)	60	40	5	50	40	25	500	0.5	1.0	100	5							13
MPS6531	TO-92 (72)	60	40	5	50	40	50	500	0.3	1.0	100	5							13
MPS6532	TO-92 (72)	50	30	5	100	30	30	100	0.5	1.2	100	5							13
MPS6564	TO-92 (72)		45	5	500	40	25	10	0.5	10	4								27
MPS6565	TO-92 (72)	60	45	4	100	30	40	160	0.4	10	3.5								27
MPS6566	TO-92 (72)	60	45	4	100	30	100	400	0.4	10	3.5				200				27
MPS6573	TO-92 (72)		35		100	35	100	100	0.5	10	12				100	300			02
MPS6574	TO-92 (72)		35		100	35	100	300	0.5	10	12				100	300			02
MPS6575	TO-92 (72)		45		100	45	100	100	0.5	10	12				100	300			02
MPS6576	TO-92 (72)		45		100	45	100	300	0.5	10	12				100	300			02
NCBT13	TO-92 (72)	60	40	4	100	30	40	20	0.15	100	6				150				13
NS3903	TO-18	60	40	6			15	100	0.2	0.85	10	4			250			6	23

TEST CONDITIONS:

(1) IC = 300  $\mu$ A, VCE = 10V, f = 1kHz. (2) IC = 150mA, VCC = 30V, IB1 = IB2 = 15mA. (3) IC = 100  $\mu$ A, VCE = 10V, f = 1kHz. (4) IC = 300mA, VCC = 25V, IB1 = IB2 = 30mA. (5) IC = 100  $\mu$ A, VCE = 4.5V, f = 15.7kHz. (6) IC = 10mA, VCC = 3V, IB1 = IB2 = 1mA. (7) IC = 100  $\mu$ A, VCE = 5V, f = 15.7kHz. (8) IC = 250  $\mu$ A, VCE = 5V, f = 10Hz-15.7kHz. (9) IC = 3mA, VCE = 10V, f = 1MHz. (10) IC = 10  $\mu$ A, VCE = 5V, f = 15.7kHz.



## GENERAL PURPOSE AMPS AND SWITCHES (Continued)

Type No.	Case Style	V <sub>CB0</sub> (V)		V <sub>CE0</sub> (V)		V <sub>EB0</sub> (V)		I <sub>CB0</sub> (nA) @ V <sub>CB</sub> (V)		h <sub>FE</sub> @ I <sub>C</sub> & V <sub>CE</sub> (V)		V <sub>CE(SAT)</sub> (V) & V <sub>BE(SAT)</sub> (V) @ I <sub>C</sub> (mA)		C <sub>ob</sub> (pF) @ I <sub>C</sub> (mA)		f <sub>T</sub> (MHz) @ I <sub>C</sub> (mA)		t <sub>off</sub> (ns) Max		NF (dB) Max	Test Condition	Process No.	
		Min	Max	Min	Max	Min	Max	Min	Max	Min	Max	Min	Max	Min	Max	Min	Max						
NS3904	TO-18	60		40		6				30 60	100 50	1 1	0.2 0.3	0.85 0.95	10 50	4		300 250	10	250		6	23
2N4424	TO-92 (74)	40		40		5		100	25	180	540	2	0.3	0.6	1.3	50							04
2N4944	TO-92 (72)	Same as PN2222A, see page 1-22 for explanation																					
2N4945	TO-92 (74)	60		30		5		50	40	60	200	150	10	10	10	8		250	20	400		2	13
2N4951	TO-92 (74)	60		30		5		50	40	40	300	150	10	10	10	8		250	20	400		2	13
2N4952	TO-92 (74)	60		30		5		50	40	75	10	10	0.3	1.3	150	8		250	20	400		2	13
2N4953	TO-92 (74)	60		30		5		50	40	200	600	150	10	10	8			250	20	400		2	13
2N4954	TO-92 (74)	40		30		5		50	30	60	600	150	10	10	8			250	20	400		2	13
2N4969	TO-92 (72)	Same as PN2221, see page 1-21 for explanation																					
2N4970	TO-92 (72)	Same as PN2222, see page 1-22 for explanation																					
2N5127	TO-92 (72)	Same as PN5127, see page 1-22 for explanation																					
2N5128	TO-92 (72)	Same as PN5128, see page 1-22 for explanation																					
2N5129	TO-92 (72)	Same as PN5129, see page 1-23 for explanation																					
2N5131	TO-92 (72)	Same as PN5131, see page 1-23 for explanation																					
2N5132	TO-92 (72)	Same as PN5132, see page 1-23 for explanation																					
2N5135	TO-92 (72)	Same as PN5135, see page 1-23 for explanation																					
2N5136	TO-92 (72)	Same as PN5136, see page 1-23 for explanation																					



### GENERAL PURPOSE AMPS AND SWITCHES (Continued)

Type No.	Case Style	V <sub>CB0</sub> (V) Min	V <sub>CE0</sub> (V) Min	V <sub>EBO</sub> (V) Min	I <sub>CB0</sub> (mA) @ V <sub>CB0</sub> Max	h <sub>FE</sub> Min	I <sub>C</sub> & V <sub>CE</sub> (mA) & (V)	V <sub>CE(SAT)</sub> (V) & V <sub>BE(SAT)</sub> (V) @ I <sub>C</sub> (mA)		C <sub>ob</sub> (pF) Max	f <sub>T</sub> (MHz)		t <sub>off</sub> (ns) Max	NF (dB) Max	Test Condition	Process No.
								Max	Min		Min	Max				
2N5137	TO-92 (72)	25	25	5	100	100	500	10	10	10						19
2N5172	TO-92 (74)	20	15	3	100	35	500	2	10	4	150	10				04
2N5219	TO-92 (72)	15	15	3	100	30	600	50	10	10	100	20				27
2N5220	TO-92 (72)	25	20	3	100	50	800	2	10	4	150	10				13
2N5223	TO-92 (72)	25	25	4	300	30	600	50	10	20	50	20				27
2N5225	TO-92 (72)	160	140	6	100	20	50	5	10	6	100	300	10	10		13
2N5550	TO-92 (72)	180	160	6	50	80	250	10	5	5	100	300	10	8		16
2N5551	TO-92 (72)	50	40	5	100	25	500	2	2	15	100	50				16
2N5816	TO-92 (77)	60	30	5	10	30	500	10	10	8	50	20				13
TN2219	TO-92+ (91)	75	40	6	10	60	500	10	10	8	60	20	4	3		19

Same as PN5137, see page 1-23 for explanation

#### TEST CONDITIONS:

(1) I<sub>C</sub> = 300 μA, V<sub>CE</sub> = 10V, f = 1kHz. (2) I<sub>C</sub> = 150mA, V<sub>CC</sub> = 30V, I<sub>B</sub><sup>1</sup> = I<sub>B</sub><sup>2</sup> = 15mA. (3) I<sub>C</sub> = 100 μA, V<sub>CE</sub> = 10V, f = 1kHz. (4) I<sub>C</sub> = 300mA, V<sub>CC</sub> = 25V, I<sub>B</sub><sup>1</sup> = I<sub>B</sub><sup>2</sup> = 30mA. (5) I<sub>C</sub> = 100 μA, V<sub>CE</sub> = 4.5V, f = 15.7kHz. (6) I<sub>C</sub> = 10mA, V<sub>CC</sub> = 3V, I<sub>B</sub><sup>1</sup> = I<sub>B</sub><sup>2</sup> = 1mA. (7) I<sub>C</sub> = 100 μA, V<sub>CE</sub> = 5V, f = 15.7kHz. (8) I<sub>C</sub> = 250 μA, V<sub>CE</sub> = 5V, f = 10Hz-15.7kHz. (9) I<sub>C</sub> = 3mA, V<sub>CE</sub> = 10V, f = 1MHz. (10) I<sub>C</sub> = 10 μA, V<sub>CE</sub> = 5V, f = 15.7kHz.

# NPN Transistors



## MEDIUM POWER

Type No.	Case Style	V <sub>CB0</sub> (V) Min	V <sub>CE0</sub> (V) Min	V <sub>EB0</sub> (V) Min	I <sub>CB0</sub> (mA) Max	I <sub>CEB*</sub> (V) Min	I <sub>CEB</sub> (V) Max	h <sub>FE</sub> Min	h <sub>FE</sub> Max	I <sub>C</sub> (mA) Max	V <sub>CE</sub> (V) & V <sub>CE</sub> (V)	V <sub>CE(sat)</sub> (V) Max	V <sub>BE(sat)</sub> (V) Min	I <sub>C</sub> (mA) Max	C <sub>ob</sub> (pF) Max	f <sub>T</sub> (MHz) Min	f <sub>T</sub> (MHz) Max	t <sub>off</sub> (ns) Max	NF (dB) Max	Test Condition	Process No.
2N699	TO-39	120	60	5	2	60	60	40	120	150	10	5	1.3	150	20	50	50				12
2N2017	TO-39	60	60	8	10 μA	30	30	20	200	200 mA	15	2		200							12
2N2102	TO-39	120	65	7	2	60	60	25	10	1A	10	0.5	1.1	150	15	60	50		6	1	12
2N2192	TO-39	60	40	5	10	30	30	35	15	1A	10	0.35	1.3	150	10	50	50				12
2N2192A	TO-39	60	40	5	10	30	30	70	150	500	10	0.25	1.3	150	20	50	50				12
2N2193	TO-39	80	50	8	10	60	60	100	300	150	10	0.35	1.3	150	20	50	50				12
2N2193A	TO-39	80	50	8	10	60	60	15	15	1A	10	0.25	1.3	150	20	50	50				12
2N2195	TO-39	45	25	5	100	30	30	20	150	10	1	0.35	1.3	150	20	50	50				12
2N2195A	TO-39	45	25	5	100	30	30	40	120	150	10	0.25	1.3	150	20	50	50				12



### MEDIUM POWER (Continued)

Type No.	Case Style	V <sub>CB0</sub> (V) Min	V <sub>CE0</sub> (V) Min	V <sub>EBO</sub> (V) Min	ICES* ICB0 (mA) Max	V <sub>CB</sub> (V)	hFE Min	hFE Max	IC @ VCE & V (mA) (V)	V <sub>CE(sat)</sub> (V) Max	V <sub>BE(sat)</sub> (V) Min	IC @ VBE(sat) & VCE (mA) (V) Max	C <sub>ob</sub> (pF) Max	f <sub>T</sub> (MHz) Min	f <sub>T</sub> (MHz) Max	t <sub>off</sub> (ns) Max	NF (dB) Max	Test Condition	Process No.
2N2243	TO-39	120	80	7	10	60	15	300	10	0.35	1.3	150	15	50	50				12
2N2243A	TO-39	120	80	7	10	60	15	300	10	0.25	1.3	150	15	50	50				12
2N2270	TO-39	60	45	7	50	60	30	200	10	0.9	1.2	150	15	100	50		6	1	12
2N2657	TO-39	80	50	8	100	60	15	5A	6	0.5	1.5	1A	150	20	200	1.5		2	34
2N2658	TO-39	100	80	8	100	60	15	5A	6	0.5	1.5	1A		20	200	1.5		2	34
2N2890	TO-39	100	80	5	50 μA	60	25	2A	5	0.5	1.2	1A	70	30	200	1.5		3	34
2N2891	TO-39	100	80	5	50 μA	60	30	90	2	0.75	1.3	2A		30	200	1.5		3	34
2N3019	TO-39	140	80	7	10	90	15	1A	10	0.2	1.1	150	12	100	50		4	4	12
2N3019 J, JTX, JTXV	TO-39	140	80	7	10*	90	15	1A	10	0.2	1.1	150	12	100	400	50		4	12

#### TEST CONDITIONS:

(1) I<sub>C</sub> = 300 μA, V<sub>CE</sub> = 10V, f = 15.7kHz. (2) I<sub>C</sub> = 1A, V<sub>CC</sub> = 20V, I<sub>B</sub><sup>1</sup> = I<sub>B</sub><sup>2</sup> = 100mA. (3) I<sub>C</sub> = 1A, V<sub>CC</sub> = 20V, I<sub>B</sub><sup>1</sup> = I<sub>B</sub><sup>2</sup> = 50mA. (4) I<sub>C</sub> = 100 μA, V<sub>CE</sub> = 10V, f = 1kHz. (5) I<sub>C</sub> = 150mA, V<sub>CC</sub> = 20V, I<sub>B</sub><sup>1</sup> = I<sub>B</sub><sup>2</sup> = 7.5mA. (6) I<sub>C</sub> = 30 μA, V<sub>CE</sub> = 10V, f = 1kHz. (7) I<sub>C</sub> = 150mA, V<sub>EB</sub> = 2V, I<sub>B</sub><sup>1</sup> = I<sub>B</sub><sup>2</sup> = 15mA. (8) I<sub>C</sub> = 500 μA, V<sub>CE</sub> = 10V, f = 1kHz. (9) I<sub>C</sub> = 2A, V<sub>CC</sub> = 40V, I<sub>B</sub><sup>1</sup> = I<sub>B</sub><sup>2</sup> = 200mA.



## MEDIUM POWER (Continued)

Type No.	Case Style	V <sub>CB0</sub> (V) Min	V <sub>CE0</sub> (V) Min	V <sub>EB0</sub> (V) Min	I <sub>CB0</sub> (mA) Max	V <sub>CB</sub> (V)	h <sub>FE</sub> Min	I <sub>C</sub> (mA) Max	V <sub>CE</sub> (V)	V <sub>CE(EST)</sub> (V) Max	V <sub>BE(EST)</sub> (V) Min	I <sub>C</sub> (mA) Max	C <sub>ob</sub> (pF) Max	f <sub>T</sub> (MHz) Min	I <sub>C</sub> (mA) Max	t <sub>off</sub> (ns) Max	NF (dB) Max	Test Condition	Process No.	
2N3020	TO-39	140	80	7	10	90	15	1A	10	0.2	1.1	150	12	80	50				12	
							30	100	10	0.5		500								
							40	120	10											
							30	100	10											
2N3053	TO-39	60	40	5	250	30	50	250	10	1.4	1.7	150	15	100	50				12	
							25	150	2.5											
2N3107	TO-39	100	60	7	10	60	40	500	10	0.25	1.1	150	20	70	50	1000	7	5/6	12	
							100	300	1											
							35	0.1	10	1.0	2.0	1A								
2N3108	TO-39	100	60	7	10	60	35	500	10	0.25	1.1	150	20	60	50	600	7	5/6	12	
							40	120	10											
							20	0.1	10	1.0	2.0	1A								
2N3109	TO-39	80	40	7	10*	60	40	500	10	0.25	1.1	150	25	70	50	1000	7	5/6	12	
							100	300	1											
							35	0.1	10	1.0	2.0	1A								
2N3110	TO-39	80	40	7	10*	60	25	500	10	0.25	1.1	150	25	60	50	600	7	5/6	12	
							40	150	1											
							20	0.1	10	1.0	2.0	1A								
2N3114	TO-39	150	150	5	10	100	30	120	10	1.0	0.9	50	9	40	30				08	
							15	0.1	10											
2N3488	TO-39	100	100	6	50	50	15	500	10	0.2	0.8	10	10	150	20				08	
							40	120	10	0.25	0.9	50								
							35	10	10	0.6	1.4	300								
							25	1	10											
							20	0.1	10											
2N3488	TO-39	100	100	6	50	50	15	500	10	0.2	0.8	10	10	150	800	20	1150	16	7/8	08
							40	120	10	0.6	1.4	300								
							35	10	10											
							25	1	10											
							20	0.1	10											
2N3488	TO-39	100	100	6	50	50	15	500	10	0.2	0.8	10	10	150	800	20	1150	16	7/8	08
							40	120	10	0.6	1.4	300								
							35	10	10											
							25	1	10											
							20	0.1	10											
2N3488	TO-39	100	100	6	50	50	15	500	10	0.2	0.8	10	10	150	800	20	1150	16	7/8	08
							40	120	10	0.6	1.4	300								
							35	10	10											
							25	1	10											
							20	0.1	10											
2N3489	TO-39	100	100	6	50	50	20	500	10	0.2	0.8	10	10	150	20				08	
							100	300	10	0.25	0.9	50								
							75	10	10	0.6	1.4	300								
							50	1	10											
							35	0.1	10											





MEDIUM POWER (Continued)

Type No.	Case Style	V <sub>CEO</sub> (V) Min	V <sub>CEO</sub> (V) Min	V <sub>BE0</sub> (V) Min	I <sub>CEO</sub> * (mA) Max	V <sub>CB</sub> (V) Min	I <sub>CB0</sub> (mA) Max	I <sub>FE</sub> Min	I <sub>FE</sub> Max	I <sub>C</sub> @ (mA)	V <sub>CE</sub> (V)	V <sub>CE(sat)</sub> (V) Max	V <sub>BE(sat)</sub> (V) Min	V <sub>BE(sat)</sub> (V) Max	I <sub>C</sub> @ (mA) Min	I <sub>C</sub> @ (mA) Max	C <sub>ob</sub> (pF) Max	f <sub>T</sub> (MHz) Min	f <sub>T</sub> (MHz) Max	t <sub>off</sub> (ns) Max	NF (dB) Max	Test Condition	Process No.
2N3499 J, JTX, JTXV	TO-39	100	100	6	50	50	50	20	300	150	10	0.2	0.8	1.4	10	800	10	150	800	1150	16	7/8	08
2N3500	TO-39	150	150	6	75	75	50	15	120	300	10	0.2	0.8	1.2	10	20	8	150	20				0.8
2N3500 J, JTX, JTXV	TO-39	150	150	6	75	75	50	15	120	300	10	0.2	0.8	1.2	10	20	8	150	800	1150	16	7/8	08
2N3501	TO-39	150	150	6	75	75	50	20	300	300	10	0.2	0.8	1.2	10	20	8	150	20				08
2N3501 J, JTX, JTXV	TO-39	150	150	6	75	75	50	20	300	300	10	0.2	0.8	1.2	10	20	8	150	800	1150	16	7/8	08
2N3566	TO-92 (72)	Same as PN3566, see page 1-39 for explanation																				14	
2N3567	TO-92 (72)	Same as PN3567, see page 1-39 for explanation																				14	
2N3568	TO-92 (72)	Same as PN3568, see page 1-39 for explanation																				12	
2N3569	TO-92 (72)	Same as PN3569, see page 1-39 for explanation																				14	
2N3665	TO-39	120	80	10	50	60	25	40	30	500	10	0.5	1.2	1.8	150	60	12	60	50				12

TEST CONDITIONS:

(1) I<sub>C</sub> = 300 μA, V<sub>CE</sub> = 10V, f = 15.7kHz. (2) I<sub>C</sub> = 1A, V<sub>CC</sub> = 20V, I<sub>B</sub><sup>1</sup> = I<sub>B</sub><sup>2</sup> = 100mA. (3) I<sub>C</sub> = 1A, V<sub>CC</sub> = 20V, I<sub>B</sub><sup>1</sup> = I<sub>B</sub><sup>2</sup> = 50mA. (4) I<sub>C</sub> = 100 μA, V<sub>CE</sub> = 10V, f = 1kHz. (5) I<sub>C</sub> = 150mA, V<sub>CC</sub> = 20V, I<sub>B</sub><sup>1</sup> = I<sub>B</sub><sup>2</sup> = 7.5mA. (6) I<sub>C</sub> = 30 μA, V<sub>CE</sub> = 10V, f = 1kHz. (7) I<sub>C</sub> = 150mA, V<sub>EB</sub> = 2V, I<sub>B</sub><sup>1</sup> = I<sub>B</sub><sup>2</sup> = 15mA. (8) I<sub>C</sub> = 500 μA, V<sub>CE</sub> = 10V, f = 1kHz. (9) I<sub>C</sub> = 2A, V<sub>CC</sub> = 40V, I<sub>B</sub><sup>1</sup> = I<sub>B</sub><sup>2</sup> = 200mA.

# NPN Transistors



## MEDIUM POWER (Continued)

Type No.	Case Style	V <sub>CB0</sub> (V) Min	V <sub>CE0</sub> (V) Min	V <sub>EB0</sub> (V) Min	ICES* ICB0 (mA) @ V <sub>CB</sub> (V) Max	hFE Min	hFE Max @ IC (mA)	V <sub>CE(sat)</sub> (V) Max & V <sub>CE</sub> (V)	V <sub>BE(sat)</sub> (V) Min	IC (mA) @ V <sub>BE(sat)</sub> (V) Max	C <sub>ob</sub> (pF) Max	f <sub>T</sub> (MHz) @ IC (mA) Min Max	t <sub>off</sub> (ns) Max	NF (dB) Max	Test Condition	Process No.
2N3666	TO-39	120	80	10	50 60	50 100 70	500 150 10	10 10	1.2 1.8	150 500	12	60				12
2N3700 J, JTX, JTXV	TO-18	140	80	7	10 90	15 50 100 90 50	1A 500 300 150 10 1	10 10 10 10 10	1.1 1.5	150 500	12	100 200		4	4	12
2N3700	TO-18	140	80	7	10 90	15 50 100 90 50	1A 500 300 150 10 1	10 10 10 10 10	1.1 1.5	150 500	12	100 400		4	4	12
2N3742	TO-39	300	300	7	200 200	20 20 15 10	50 200 30 10 3	20 10 10 10	1.0 1.2	10 30	6	60				48
2N3945	TO-39	70	50	8	40 60	20 40 25	500 150 10	10 10 10	1.8 1.2	500 150	12	60				12
2N4237	TO-39		40		100 μA 50	15 30 30	1A 500 250 1	1 4	1.5 1.5	1A 500	100	1				14
2N4924	TO-39	100	100	5	100 50	40 35 25	150 10 1	10 10 10	0.25 0.4	10 50	10	10 500				12
2N4926	TO-39	200	200	7	100 100	20 15 10	50 30 10 3	20 10 10			6	30 300				48
2N4927	TO-39	250	250	7	100 150	20 20 15 10	50 30 10 3	20 10 10 10			6	30 300				48
2N5148	TO-39		80		1 μA* 60	5 15 30 20	3A 2A 1A 50	5 5 5 5	0.85 1.2	200 100	70	50				34



MEDIUM POWER (Continued)

Type No.	Case Style	V <sub>CEO</sub> (V) Min	V <sub>CBO</sub> (V) Min	V <sub>CEO</sub> (V) Min	V <sub>EB0</sub> (V) Min	I <sub>CB0</sub> (mA) Max	I <sub>CB0</sub> @ V <sub>CB</sub> (V) Max	h <sub>FE</sub> @ I <sub>C</sub> (mA) & V <sub>CE</sub> (V) Min Max	V <sub>CE(sat)</sub> (V) & V <sub>BE(sat)</sub> (V) Max Min	I <sub>C</sub> (mA) Max	C <sub>ob</sub> (pF) Max	f <sub>T</sub> (MHz) Min Max	I <sub>C</sub> (mA) Max	t <sub>off</sub> (ns) Max	NF (dB) Max	Test Condition	Process No.
2N5150	TO-39	80		80	60	1 μA*	60	15 30 70 50	3A 2A 200 1A 50	5 5 3A 5	0.46	1.2	100	200	70		34
2N5336	TO-39	80		80	80	10 μA	80	20 30 30	5A 120 2A 500	2 2 2	0.7	1.2	2A	500	2200	9	34
2N5338	TO-39	100		100	100	10 μA	100	20 30 30	5A 120 2A 500	2 2 2	0.7	1.2	2A	500	2200	9	34
40314	TO-39	40		40	15	70	350	50	4	1.4	1.4	150					12
40321	TO-39	300		300	150	200	20	25	10								48
92PE37A	TO-92+ (90)	45		45	60	100	60	40 40 25	500 250 50	2 2 2	0.5	1.0	500	200	30		38
92PE37B	TO-92+ (90)	60		60	80	100	80	40 40 25	500 250 50	2 2 2	0.5	1.0	500	200	30		38
92PE37C	TO-92+ (90)	80		80	100	100	100	40 40 25	500 250 50	2 2 2	0.5	1.0	500	200	30		38
92PE487	TO-92+ (90)	160		160	7	50	100	30 15 15	30 10 1	10 10 10	1.0	30	30		3		48
92PE488	TO-92+ (90)	250		250	7	50	200	30 15 15	30 10 1	10 10 10	1.0	30	30		3		48
92PE489	TO-92+ (90)	300		300	7	50	200	30 15 15	30 10 1	10 10 10	1.0	30	30		3		48
92PU01	TO-92+ (91)			30		100	40	50 60 55	1A 100 10	1 1 1	0.5	1A	50		30		37
92PU01A	TO-92+ (91)	40		40	50	100	50	50 60 55	1A 100 10	1 1 1	0.5	1A	50		30		37

TEST CONDITIONS:

(1) I<sub>C</sub> = 300 μA, V<sub>CE</sub> = 10V, f = 15.7kHz. (2) I<sub>C</sub> = 1A, V<sub>CC</sub> = 20V, I<sub>B</sub><sup>1</sup> = I<sub>B</sub><sup>2</sup> = 100mA. (3) I<sub>C</sub> = 1A, V<sub>CC</sub> = 20V, I<sub>B</sub><sup>1</sup> = I<sub>B</sub><sup>2</sup> = 50mA. (4) I<sub>C</sub> = 100 μA, V<sub>CE</sub> = 10V, f = 1kHz. (5) I<sub>C</sub> = 150mA, V<sub>CC</sub> = 20V, I<sub>B</sub><sup>1</sup> = I<sub>B</sub><sup>2</sup> = 7.5mA. (6) I<sub>C</sub> = 30 μA, V<sub>CE</sub> = 10V, f = 1kHz. (7) I<sub>C</sub> = 150mA, V<sub>EB</sub> = 2V, I<sub>B</sub><sup>1</sup> = I<sub>B</sub><sup>2</sup> = 15mA. (8) I<sub>C</sub> = 500 μA, V<sub>CE</sub> = 10V, f = 1kHz. (9) I<sub>C</sub> = 2A, V<sub>CC</sub> = 40V, I<sub>B</sub><sup>1</sup> = I<sub>B</sub><sup>2</sup> = 200mA.

# NPN Transistors



## MEDIUM POWER (Continued)

Type No.	Case Style	V <sub>CB0</sub> (V) Min	V <sub>CE0</sub> (V) Min	V <sub>EBO</sub> (V) Min	I <sub>CE0</sub> * I <sub>CB0</sub> (mA) Max	V <sub>CB</sub> (V)	h <sub>FE</sub> Min	I <sub>C</sub> (mA) Max	V <sub>CE</sub> (V) & V <sub>CE</sub> (V)	V <sub>CE</sub> (sat) (V) Max	V <sub>BE</sub> (sat) (V) Min	I <sub>C</sub> (mA) Max	C <sub>ob</sub> (pF) Max	f <sub>T</sub> (MHz) Min	f <sub>T</sub> (MHz) Max	t <sub>off</sub> (ns) Max	NF (dB) Max	Test Condition	Process No.
92PU05	TO-92+ (91)		60		100	40	20	500	1	0.35		250	30	50	200				39
92PU06	TO-92+ (91)		100		100	80	20	500	1	0.35		250	30	50	200				39
92PU10	TO-92+ (91)		300		100	200	40	30	10	0.75		30	3.5						48
92PU100	TO-92+ (91)	100	80		100	80	100	300	2	0.35		350	20	50	100				39
92PU391	TO-92+ (91)	200	200	6	100	160	40	10	10	2.0	2.0	20	2.5	50	10				48
92PU392	TO-92+ (91)	250	250	6	100	200	40	10	10	2.0	2.0	20	2.5	50	10				48
92PU393	TO-92+ (91)	300	300	6	100	260	40	10	10	2.0	2.0	20	2.5	50	10				48
D40D1	TO-202 (35)		30		100*	45	10	1A	2	0.5	1.5	500							38
D40D2	TO-202 (35)		30		100*	45	20	1A	2	0.5	1.5	500							38
D40D3	TO-202 (35)		30		100*	45	10	1A	2			500							38
D40D4	TO-202 (35)		45		100*	60	10	1A	2	0.5	1.5	500							38
D40D5	TO-202 (35)		45		100*	60	120	360	2	0.5	1.5	500							38
D40D6	TO-202 (35)		60		100*	75	10	1A	2	1.0	1.5	500							38
D40D8	TO-202 (35)		60		100*	75	50	150	2	1.0	1.5	500							38
D40D10	TO-202 (35)		75		100*	90	120	360	2	1.0	1.5	500							38
D40D11	TO-202 (35)		75		100*	90	10	1A	2	1.0	1.5	500							38
D40D13	TO-202 (35)		75		100*	90	50	150	2	1.0	1.5	500							38

**MEDIUM POWER (Continued)**

Type No.	Case Style	V <sub>CE0</sub> (V) Min	V <sub>BE0</sub> (V) Min	V <sub>CE0</sub> (V) Min	V <sub>BE0</sub> (V) Min	ICES* I <sub>CB0</sub> (mA) @ V <sub>CB</sub> (V) Max	h <sub>FE</sub> Min	I <sub>C</sub> @ V <sub>CE</sub> & V <sub>BE(sat)</sub> (mA)	V <sub>CE(sat)</sub> (V) Max	V <sub>BE(sat)</sub> (V) Min	I <sub>C</sub> @ V <sub>CE</sub> & V <sub>BE(sat)</sub> (mA) Max	C <sub>ob</sub> (pF) Max	f <sub>T</sub> (MHz) Min	f <sub>T</sub> (MHz) @ I <sub>C</sub> (mA) Max	t <sub>off</sub> (ns) Max	NF (dB) Max	Test Condition	Process No.
D40D14	TO-202 (35)	75	100*	90	100*	100	120	360	100	2	1.0	1.5	500					38
D40E1	TO-202 (35)	30	100*	40	100*	1A	10	1A	2	1.0	1.3	1A						38
D40E5	TO-202 (35)	60	100*	70	100*	1A	10	1A	2	1.0	1.3	1A						38
D40E7	TO-202 (35)	80	100*	90	100*	1A	10	1A	2	1.0	1.3	1A						38
D40N1	TO-202 (35)	250	10 μA	250	10 μA	40	20	40	10	10			3	75	20			48
D40N2	TO-202 (35)	250	10 μA	250	10 μA	180	30	40	10	10			3	75	20			48
D40N3	TO-202 (35)	300	10 μA	300	10 μA	40	20	40	10	10			3	75	20			48
D40N4	TO-202 (35)	300	10 μA	300	10 μA	180	30	40	10	10			3	75	20			48
D40N5	TO-202 (35)	375	10 μA	300	10 μA	40	15	40	10	10			3	75	20			48
D42C1	TO-202 (36)	30	1 μA*	30	1 μA*	1A	10	1A	1	0.5	1.3	1A	30					37
D42C2	TO-202 (36)	30	1 μA*	30	1 μA*	1A	20	1A	1	0.5	1.3	1A	30					37
D42C3	TO-202 (36)	30	1 μA*	30	1 μA*	2A	20	2A	1	0.5	1.3	1A	30					37
D42C4	TO-202 (36)	45	1 μA*	45	1 μA*	1A	10	1A	1	0.5	1.3	1A	30					37
D42C5	TO-202 (36)	45	1 μA*	45	1 μA*	1A	20	1A	1	0.5	1.3	1A	30					37
D42C6	TO-202 (36)	45	1 μA*	45	1 μA*	2A	20	2A	1	0.5	1.3	1A	30					37

**TEST CONDITIONS:**

(1) I<sub>C</sub> = 300 μA, V<sub>CE</sub> = 10V, f = 15.7kHz. (2) I<sub>C</sub> = 1A, V<sub>CE</sub> = 20V, I<sub>B</sub><sup>1</sup> = I<sub>B</sub><sup>2</sup> = 100mA. (3) I<sub>C</sub> = 1A, V<sub>CE</sub> = 20V, I<sub>B</sub><sup>1</sup> = I<sub>B</sub><sup>2</sup> = 50mA. (4) I<sub>C</sub> = 100 μA, V<sub>CE</sub> = 10V, f = 1kHz. (5) I<sub>C</sub> = 150mA, V<sub>CE</sub> = 20V, I<sub>B</sub><sup>1</sup> = I<sub>B</sub><sup>2</sup> = 7.5mA. (6) I<sub>C</sub> = 30 μA, V<sub>CE</sub> = 10V, f = 1kHz. (7) I<sub>C</sub> = 150mA, V<sub>EB</sub> = 2V, I<sub>B</sub><sup>1</sup> = I<sub>B</sub><sup>2</sup> = 15mA. (8) I<sub>C</sub> = 500 μA, V<sub>CE</sub> = 10V, f = 1kHz. (9) I<sub>C</sub> = 2A, V<sub>CE</sub> = 40V, I<sub>B</sub><sup>1</sup> = I<sub>B</sub><sup>2</sup> = 200mA.

# NPN Transistors

## MEDIUM POWER (Continued)

Type No.	Case Style	V <sub>CE0</sub> (V) Min	V <sub>CE0</sub> (V) Min	V <sub>BE0</sub> (V) Min	I <sub>CB0</sub> * (mA) Max	V <sub>CE</sub> (V) & I <sub>C</sub> (mA) Min	h <sub>FE</sub> Min	I <sub>C</sub> (mA) Max	V <sub>CE(sat)</sub> (V) Max	V <sub>BE(sat)</sub> (V) Min	I <sub>C</sub> (mA) Max	C <sub>ob</sub> (pF) Max	f <sub>T</sub> (MHz) Min	I <sub>C</sub> (mA) Max	t <sub>off</sub> (ns) Max	NF (dB) Max	Test Condition	Process No.
D42C7	TO-202 (36)	60	60	1 μA*	60	1 A 1	10	1 A	0.5	1.3	1 A	30						38
D42C8	TO-202 (36)	60	60	1 μA*	60	1 A 1	20	1 A	0.5	1.3	1 A	30						38
D42C9	TO-202 (36)	60	60	1 μA*	60	2 A 1	20	2 A	0.5	1.3	1 A	30						38
D42C10	TO-202 (36)	80	80	10 μA*	90	1 A 1	10	1 A	0.5	1.3	1 A	100						38
D42C11	TO-202 (36)	80	80	10 μA*	90	1 A 1	20	1 A	0.5	1.3	1 A	100						38
D42C12	TO-202 (36)	80	80	10 μA*	90	2 A 1	20	2 A	0.5	1.3	1 A	100						38
MPSA05	TO-92 (72)	60	4	100	60	100 1	50	100	0.25		100		100	100				12
MPSA06	TO-92 (72)	80	4	100	80	100 1	50	100	0.25		100		100	100				12
MPSA42	TO-92 (72)	300	8	100	200	30 10	40	30	0.5	0.9	20	3	50	10				48
MPSA43	TO-92 (72)	200	6	100	160	30 10	50	200	0.4	0.9	20	4	50	10				48
MPS6560	TO-92 (72)	25	5	100	20	500 1	50	200	0.5		500	30	60	10				14
MPS6561	TO-92 (72)	20	5	100	20	500 1	50	200	0.5		350	30	60	10				14
MRF8004	TO-39	60	3	10 μA	50	400 2	10	400				70						35
NCBS14	TO-39	60	4	100	30	20 1	60	20	0.15		100	10	125	20				14
NCBS35	TO-39	65	3	10 μA	40	100 1	30	150	0.5		1 A	35	120	100				35
NCBV14	TO-202 (35)	60	4	100	30	50 1	75	50	0.4		500	100	125	50				14
NCBX14	TO-92+ (91)	60	4	100	30	20 1	60	20	0.15		100	10	125	20				14
NSD102	TO-202 (35)	60	45	5	100	60 5	25	1 A	0.2	0.9	100	30	60	50				37
						50 5	40	500		1.2	500							
						50 5	50	150	0.4									
						10 5	40	10										



**MEDIUM POWER (Continued)**

Type No.	Case Style	V <sub>CEO</sub> (V) Min	V <sub>CE0</sub> (V) Min	V <sub>BE0</sub> (V) Min	I <sub>CE0</sub> <sup>*</sup> (mA) Max	h <sub>FE</sub> Min	I <sub>C</sub> @ V <sub>CE</sub> & V <sub>BE</sub> (mA) & (V)	V <sub>CE(sat)</sub> (V) & V <sub>BE(sat)</sub> (V)	I <sub>C</sub> @ V <sub>CE</sub> & V <sub>BE</sub> (mA)	C <sub>ob</sub> (pF) Max	f <sub>T</sub> (MHz) Min	I <sub>C</sub> @ f <sub>T</sub> (mA) Max	t <sub>off</sub> (ns) Max	NF (dB) Max	Test Condition	Process No.
NSD103	TO-202 (35)	60	45	5	100	30	1A, 5	0.2	0.9, 100	30	60	50				37
NSD104	TO-202 (35)	100	80	7	100	10	1A, 5	0.2	0.9, 100	30	60	50				39
NSD105	TO-202 (35)	100	80	7	100	10	1A, 5	0.2	0.9, 100	30	60	50				39
NSD106	TO-202 (35)	140	100	7	100	25	500, 5	0.2	0.9, 100	30	60	50				39
NSD123	TO-202 (35)	120	120	6	50	15	300, 10	0.4	1.2, 150	10						08
NSD131	TO-202 (35)	250	250	7	100	30	90, 30	1.0	0.85, 20	3						48
NSD132	TO-202 (35)	250	250	7	100	60	180, 30	1.0	0.85, 20	3						48
NSD133	TO-202 (35)	300	300	7	100	15	30, 10									48
NSD134	TO-202 (35)	300	300	7	100	15	30, 10									48
NSD135	TO-202 (35)	375	375	7	100	30	30, 10									48
NSD457	TO-202 (35)	160	160	5	50	25	30, 10									48
NSD468	TO-202 (35)	250	250	5	50	25	30, 10									48

**TEST CONDITIONS:**

(1) I<sub>C</sub> = 300 μA, V<sub>CE</sub> = 10V, f = 15.7kHz. (2) I<sub>C</sub> = 1A, V<sub>CC</sub> = 20V, I<sub>B</sub><sup>1</sup> = I<sub>B</sub><sup>2</sup> = 100mA. (3) I<sub>C</sub> = 1A, V<sub>CC</sub> = 20V, I<sub>B</sub><sup>1</sup> = I<sub>B</sub><sup>2</sup> = 50mA. (4) I<sub>C</sub> = 100 μA, V<sub>CE</sub> = 10V, f = 1kHz. (5) I<sub>C</sub> = 150mA, V<sub>CC</sub> = 20V, I<sub>B</sub><sup>1</sup> = I<sub>B</sub><sup>2</sup> = 15mA. (6) I<sub>C</sub> = 30 μA, V<sub>CE</sub> = 10V, f = 1kHz. (7) I<sub>C</sub> = 150mA, V<sub>EB</sub> = 2V, I<sub>B</sub><sup>1</sup> = I<sub>B</sub><sup>2</sup> = 15mA. (8) I<sub>C</sub> = 500 μA, V<sub>CE</sub> = 10V, f = 1kHz. (9) I<sub>C</sub> = 2A, V<sub>CC</sub> = 40V, I<sub>B</sub><sup>1</sup> = I<sub>B</sub><sup>2</sup> = 200mA.



## MEDIUM POWER (Continued)

Type No.	Case Style	V <sub>CE0</sub> (V) Min	V <sub>CE0</sub> (V) Max	V <sub>BE0</sub> (V) Min	V <sub>BE0</sub> (V) Max	I <sub>CE0</sub> <sup>*</sup> (mA) Max	I <sub>CB0</sub> (mA) Max	V <sub>CB</sub> (V)	h <sub>FE</sub> Min	h <sub>FE</sub> Max	I <sub>C</sub> (mA) & V <sub>CE</sub> (V)	V <sub>CE(sat)</sub> (V) Max	V <sub>BE(sat)</sub> (V) Min	I <sub>C</sub> (mA) Max	C <sub>ob</sub> (pF) Max	f <sub>T</sub> (MHz) Min	f <sub>T</sub> (MHz) Max	t <sub>off</sub> (ns) Max	NF (dB) Max	Test Condition	Process No.
NSD459	TO-202 (35)	300	300	5	5	50	250	250	25	30	10	1.0		30							48
NSD3439	TO-202 (35)		350			20 μA	300	300	40	160	10	0.5	1.3	50	20	15	10				36
NSD3440	TO-202 (35)		250			500 μA	200	200	40	160	10	0.5	1.3	50	20	15	10				36
NSD6178	TO-202 (35)		75			500 μA	80	80	10	1A	2	0.5	1.2	500	30	50	50				38
NSD6179	TO-202 (35)		50			500 μA	60	60	10	1A	2	0.5	1.2	500	30	50	50				38
NSDU01	TO-202 (35)		30			100	30	30	50	1A	1	0.5	1.2	1A	30	50	50				37
NSDU01A	TO-202 (35)		40			100	40	40	50	1A	1	0.5	1.2	1A	30	50	50				37
NSDU02	TO-202 (35)		40			100	40	40	30	500	10	0.4	1.3	150	20	50	20				37
NSDU05	TO-202 (35)		60			100	60	60	20	500	1	0.35		250	50	200					38
NSDU06	TO-202 (35)		80			100	80	80	20	500	1	0.35		250	50	200					39
NSDU07	TO-202 (35)		100			100	100	100	20	500	1	0.35		250	50	200					39
NSDU10	TO-202 (35)		300			200	200	200	40	30	10	1.5	0.8	20	3	60	10				48
NSE180	TO-202 (36)		40			100	60	60	12	1A	1.5	0.9	1.5	1.5A		50	100				37
NSE181	TO-202 (36)		60			100	80	80	12	1A	1.5	0.9	1.5	1.5A		50	100				38





MEDIUM POWER (Continued)

Type No.	Case Style	V <sub>CEO</sub> (V) Min	V <sub>CE0</sub> (V) Min	V <sub>BE0</sub> (V) Min	ICES* ICBO (mA) @ V <sub>CB</sub> Max	h <sub>FE</sub> Min	IC @ V <sub>CE</sub> & V <sub>BE</sub> (mA)	V <sub>CE(sat)</sub> (V) Max	V <sub>BE(sat)</sub> (V) Min	IC @ V <sub>CE(sat)</sub> & V <sub>BE(sat)</sub> (mA) Max	C <sub>ob</sub> (pF) Max	f <sub>T</sub> (MHz) Min	f <sub>T</sub> (MHz) @ IC Max	t <sub>off</sub> (ns) Max	NF (dB) Max	Test Condition	Process No.
NSE457	TO-202 (36)	160	160	5	50	25	30	1.0		30							48
NSE458	TO-202 (36)	250	250	5	50	25	30	1.0		30							48
NSE459	TO-202 (36)	300	300	5	50	25	30	1.0		30							48
PN3566	TO-92 (72)	40	30	5	50	150	600	1.0		100	25	4	100	30			14
PN3567	TO-92 (72)	80	40	5	50	40	120	0.25		150	20	60	600	50			14
PN3568	TO-92 (72)	80	60	5	50	40	120	0.25		150	20	60	600	50			12
PN3569	TO-92 (72)	80	40	5	50	100	300	0.25		150	20	60	600	50			14
PN7055	TO-92 (72)	220	220	7	100	40	30	1.0	0.85	20	3.5	50	15				48
SE7055	TO-39	220	220	7	100	40	30	1.0	0.85	20	3.5	50	15				48
SE7056	TO-39	300	300	7	100	40	30	1.0	0.85	20	3	50	15				48
SV7056	TO-202 (35)	300	300	7	100	40	30	1.0	0.85	20	3	50	15				48
TN2102	TO-92+ (91)	120	65	7	10	10	1A	0.5	1.1	150	15	60	50				12

TEST CONDITIONS:

(1) I<sub>C</sub> = 300 μA, V<sub>CE</sub> = 10V, f = 15.7kHz. (2) I<sub>C</sub> = 1A, V<sub>CC</sub> = 20V, I<sub>B</sub><sup>1</sup> = I<sub>B</sub><sup>2</sup> = 100mA. (3) I<sub>C</sub> = 1A, V<sub>CC</sub> = 20V, I<sub>B</sub><sup>1</sup> = I<sub>B</sub><sup>2</sup> = 50mA. (4) I<sub>C</sub> = 100 μA, V<sub>CE</sub> = 10V, f = 1kHz. (5) I<sub>C</sub> = 150mA, V<sub>CC</sub> = 20V, I<sub>B</sub><sup>1</sup> = I<sub>B</sub><sup>2</sup> = 7.5mA. (6) I<sub>C</sub> = 30 μA, V<sub>CE</sub> = 10V, f = 1kHz. (7) I<sub>C</sub> = 150mA, V<sub>EB</sub> = 2V, I<sub>B</sub><sup>1</sup> = I<sub>B</sub><sup>2</sup> = 15mA. (8) I<sub>C</sub> = 500 μA, V<sub>CE</sub> = 10V, f = 1kHz. (9) I<sub>C</sub> = 2A, V<sub>CC</sub> = 40V, I<sub>B</sub><sup>1</sup> = I<sub>B</sub><sup>2</sup> = 200mA.



## MEDIUM POWER (Continued)

Type No.	Case Style	V <sub>CE0</sub> (V) Min	V <sub>CE0</sub> (V) Min	V <sub>BE0</sub> (V) Min	I <sub>CE0</sub> * (mA) Max	I <sub>CB0</sub> (mA) Max	V <sub>CB</sub> (V) Max	h <sub>FE</sub> @ I <sub>C</sub> (mA) & V <sub>CE</sub> (V)		V <sub>CE(sat)</sub> (V) Max	V <sub>BE(sat)</sub> (V) @ I <sub>C</sub> (mA)		C <sub>ob</sub> (pF) Max	f <sub>T</sub> (MHz) @ I <sub>C</sub> (mA)		t <sub>off</sub> (ns) Max	NF (dB) Max	Test Condition	Process No.
								Min	Max		Min	Max		Min	Max				
TN3019	TO-92+ (91)	140	80	7	10	90	15	1A 50 100 300 150 10	10	0.2	1.1	150	12	100	50	4	1	12	
TN3020	TO-92+ (91)	140	80	7	10	90	15	1A 30 100 40 120 150 10	10	0.2	1.1	150	12	80	50			12	
TN3053	TO-92+ (91)	60	40	5	250	30	25	50 250 150 150	10 2.5	1.4	1.7	150	15	100	50			12	

### TEST CONDITIONS:

(1) I<sub>C</sub> = 300 μA, V<sub>CE</sub> = 10V, f = 15.7kHz. (2) I<sub>C</sub> = 1A, V<sub>CC</sub> = 20V, I<sub>B</sub><sup>1</sup> = I<sub>B</sub><sup>2</sup> = 100mA. (3) I<sub>C</sub> = 1A, V<sub>CC</sub> = 20V, I<sub>B</sub><sup>1</sup> = I<sub>B</sub><sup>2</sup> = 50mA. (4) I<sub>C</sub> = 100 μA, V<sub>CE</sub> = 10V, f = 1kHz. (5) I<sub>C</sub> = 150mA, V<sub>CE</sub> = 20V, I<sub>B</sub><sup>1</sup> = I<sub>B</sub><sup>2</sup> = 7.5mA. (6) I<sub>C</sub> = 30 μA, V<sub>CE</sub> = 10V, f = 1kHz. (7) I<sub>C</sub> = 150mA, V<sub>EB</sub> = 2V, I<sub>B</sub><sup>1</sup> = I<sub>B</sub><sup>2</sup> = 15mA. (8) I<sub>C</sub> = 500 μA, V<sub>CE</sub> = 10V, f = 1kHz. (9) I<sub>C</sub> = 2A, V<sub>CC</sub> = 40V, I<sub>B</sub><sup>1</sup> = I<sub>B</sub><sup>2</sup> = 200mA.



## POWER

Type No.	Case Style	V <sub>CE0</sub> (V) Min	V <sub>CE0</sub> (V) Min	V <sub>BE0</sub> (V) Min	I <sub>CE0</sub> * (μA) Max	V <sub>CB</sub> (V) Max	h <sub>FE</sub> @ I <sub>C</sub> (A) & V <sub>CE</sub> (V)		V <sub>CE(sat)</sub> (V) Max	V <sub>BE(sat)</sub> (V) @ I <sub>C</sub> (A)		C <sub>ob</sub> (pF) Max	f <sub>T</sub> (MHz) @ I <sub>C</sub> (A)		Process
							Min	Max		Min	Max		Min	Max	
2N4921	TO-126	40	40		100	40	10 20 40	1 0.5 0.05	0.6	1.3	1	100	300	0.25	2C
2N4922	TO-126	60	60		100	60	10 20 40	1 0.5 0.05	0.6	1.3	1	100	300	0.25	2C
2N4923	TO-126	80	80		100	80	10 20 40	1 0.5 0.05	0.6	1.3	1	100	300	0.25	2C
2N5190	TO-126	40	40		100	40	10 25	4 1.5	0.6 1.4	1.5 4			2	1	2E
2N5191	TO-126	60	60		100	60	10 25	4 1.5	0.6 1.4	1.5 4			2	1	2E



## POWER (Continued)

Type No.	Case Style	V <sub>CEO</sub> (V) Min	V <sub>CE0</sub> (V) Min	V <sub>BE0</sub> (V) Min	I <sub>CEX</sub> * I <sub>CEB1</sub> I <sub>CEO</sub> (μA) Max	V <sub>CB</sub> (V) (100Ω)	hFE Min	hFE Max	I <sub>C</sub> (A) & V <sub>CE</sub> (V)	V <sub>CE(sat)</sub> & V <sub>BE(sat)</sub> (V) Min/Max	I <sub>C</sub> (A) Max	C <sub>ob</sub> (pF) Max	f <sub>T</sub> (MHz) Min/Max	I <sub>C</sub> (A) Max	Process
2N5192	TO-126	80			100	80	7	4	2	0.6	1.5		2	1	2E
2N5293	Lead Bend + Clip TO-220	10			500†	50 (100Ω)	30	120	0.5	1.0	0.5		2	0.2	4E
2N5294	TO-220	70			500†	50 (100Ω)	30	120	0.5	1.0	0.5		2	0.2	4E
2N5295	Lead Bend + Clip TO-220	40			100	35	30	120	1	1.0	1		2	0.2	4E
2N5296	TO-220	40			100	35	30	120	1	1.0	1		2	0.2	4E
2N5297	Lead Bend + Clip TO-220	60			500†	50 (100Ω)	20	80	1.5	1.0	1.5		2	0.2	4E
2N5298	TO-220	60			500†	50 (100Ω)	20	80	1.5	1.0	1.5		2	0.2	4E
2N5490	TO-220	40			5 mA*	55	5	100	6.5	2	6.5				4E
2N5491	Lead Form + Clip TO-220	40			5 mA*	55	5	100	6.5	2	6.5				4E
2N5492	TO-220	55			1 mA*	70	5	100	6.5	2	6.2				4E
2N5493	Lead Form + Clip TO-220	55			1 mA*	70	5	100	6.5	2	6.5				4E
2N5494	TO-220	40			1 mA*	55	5	100	6.5	2	6.5				4E
2N5495	Lead Form + Clip TO-220	40			1 mA*	55	5	100	6.5	2	6.5				4E
2N5496	TO-220	70			1 mA*	85	5	100	7	2	7				4E
2N5497	Lead Form + Clip TO-220	70			1 mA*	85	5	100	7	2	7				4E

# NPN Transistors



## POWER (Continued)

Type No.	Case Style	V <sub>CB0</sub> (V) Min	V <sub>CE0</sub> (V) Min	V <sub>EB0</sub> (V) Min	IC <sub>EB1</sub> * IC <sub>BO</sub> (μA) Max	V <sub>CB</sub> (V)	h <sub>FE</sub> Min Max @ (A)	IC & V <sub>CE</sub> (V) Max	V <sub>CE(sat)</sub> (V) Max	V <sub>BE(sat)</sub> (V) Min	IC (A) Max	C <sub>ob</sub> (pF) Max	f <sub>T</sub> (MHz) Min Max	IC (A) Max	Process
2N5655	TO-126		250		10	275	5 15 30 250 25	0.5 0.25 0.1 0.05 10	1.0 2.5 10		0.1 0.25 0.5	25	10	0.05	36
2N5656	TO-126		300		10	350	5 15 30 250 25	0.5 0.25 0.1 0.05 10	1.0 2.5 10		0.1 0.25 0.5	25	10	0.05	36
2N5657	TO-126		350		10	375	5 15 30 250 25	0.5 0.25 0.1 0.05 10	1.0 2.5 10		0.1 0.25 0.5	25	10	0.05	36
2N6037	TO-126		40		500	40	100 750 500	4A 2A 0.5 3	2.0 3.0	4.0 2	2 4	200	25	0.75	2J
2N6038	TO-126		60		500	60	100 750 500	4A 2A 0.5 3	2.0 3.0	4.0 2	2 4	200	25	0.75	2J
2N6039	TO-126		80		500	80	100 750 500	4A 2A 0.5 3	2.0 3.0	4.0 2	2 4	200	25	0.75	2J
2N6098	Lead Bend + Clip TO-220		60		2 mA*	65	5 20 80	10 4	2.5		10				4A
2N6099	TO-220		60		2 mA*	65	5 20 80	10 4	2.5		10				4A
2N6100	Lead Bend + Clip TO-220		70		2 mA*	75	5 20 80	10 5 4	2.5		10				4A
2N6101	TO-220		70		2 mA*	75	5 20 80	10 5 4	2.5		10				4A
2N6102	Lead Bend + Clip TO-220		40		2 mA*	40	5 15 60	16 8 4	2.5		16				4A
2N6103	TO-220		40		2 mA*	40	5 15 60	16 8 4	2.5		16				4A
2N6121	TO-220		45		100	45	10 25	4 1.5 2	0.6 1.4		1.5 4		2.5	1	4E



## POWER (Continued)

Type No.	Case Style	V <sub>CB0</sub> (V) Min	V <sub>CE0</sub> (V) Min	V <sub>EB0</sub> (V) Min	I <sub>CEX</sub> * I <sub>CEBT</sub> I <sub>CB0</sub> (μA) Max	I <sub>CB</sub> (V)	h <sub>FE</sub> Min Max @ (A)	I <sub>C</sub> & V <sub>CE</sub> (V)	V <sub>CE(sat)</sub> (V) Max & V <sub>BE(sat)</sub> (V) Min	I <sub>C</sub> (A) @ Max	C <sub>ob</sub> (pF) Max	f <sub>T</sub> (MHz) Min Max	I <sub>C</sub> (A) @ Max	Process
2N6122	TO-220		60		100	60	10 25 4 1.5 2	4 2	0.6 1.4	1.5 4		2.5	1	4E
2N6123	TO-220		80		100	80	7 20 80 1.5 2	4 2	0.6 1.4	1.5 4		2.5	1	4E
2N6129	TO-220		40		100	40	7 20 100 2.5 4	4 4	1.4	7				4E
2N6130	TO-220		60		100	60	7 20 100 2.5 4	4 4	1.4	7				4E
2N6131	TO-220		80		100	80	5 20 100 2.5 4	4 4	2.0	7				4E
2N6288	TO-220		30		100*	37.5	5 30 150 6.5 4	4 4	1.0 2.0	3 6.5	250	4	0.5	4E
2N6289	Lead Bend + Clip TO-220		30		100*	37.5	5 30 150 6.5 4	4 4	1.0 2.0	3 6.5	250	4	0.5	4E
2N6290	TO-220		50		100*	56	5 30 150 6.5 4	4 4	1.0 2.0	2.5 6.5	250	4	0.5	4E
2N6291	Lead Bend + Clip TO-220		50		100*	50	5 3 150 6.5 4	4 4	1.0 2.0	2.5 6.5	250	4	0.5	4E
2N6292	TO-220		70		100*	75	5 30 150 6.5 4	4 4	1.0 2.0	2 6.5	250	4	0.5	4E
2N6293	Lead Bend + Clip TO-220		70		100*	75	5 30 150 6.5 4	4 4	1.0 2.0	2 6.5	250	4	0.5	4E
2N6386	TO-220		40		300*	40	100 1000 20,000 8 3 3	3 3	2.0 3.0	3 8	200	20	1	4J
2N6486	TO-220		40		500*	35 (100Ω)	5 20 150 5 4	4 4	1.3 3.5	5 15				4A
2N6487	TO-220		60		500*	55 (100Ω)	5 20 150 5 4	4 4	1.3 3.5	5 15				4A
2N6488	TO-220		80		500*	75 (100Ω)	5 20 150 5 4	4 4	1.3 3.5	5 15				4A
D44C1	TO-220		30		10*	40	10 25 40 1 0.2 1	1 1	0.5	1.3 1	100	3	0.02	4F
D44C2	TO-220		30		10*	40	20 40 120 1 0.2 1	1 1	0.5	1.3 1	100	3	0.02	4F



# NPN Transistors



## POWER (Continued)

Type No.	Case Style	V <sub>CB0</sub> (V) Min	V <sub>CE0</sub> (V) Min	V <sub>EB0</sub> (V) Min	IC <sub>EX</sub> * IC <sub>EB</sub> † IC <sub>BO</sub> (μA) Max	h <sub>FE</sub> Min Max	IC & VCE (A) (V) Max	V <sub>CE(sat)</sub> (V) Max & V <sub>BE(sat)</sub> (V) Min	IC (A) Max	C <sub>ob</sub> (pF) Max	f <sub>T</sub> (MHz) Min Max	IC (A) Max	Process
D44C3	TO-220		30		10* 40	20 40	2 1 0.2 1	0.5 1.3	1 1	100	3	0.02	4E
D44C4	TO-220		45		10* 55	25	1 1 0.2 1	0.5 1.3	1 1	100	3	0.02	4F
D44C5	TO-220		45		10* 55	20 40	1 1 120 0.2 1	0.5 1.3	1 1	100	3	0.02	4F
D44C6	TO-220		45		10* 55	20 40	2 1 0.2 1	0.5 1.3	1 1	100	3	0.02	4E
D44C7	TO-220		60		10* 75	10 25	1 1 0.2 1	0.5 1.3	1 1	100	3	0.02	4F
D44C8	TO-220		60		10* 70	20 40	1 1 120 0.2 1	0.5 1.3	1 1	100	3	0.02	4F
D44C9	TO-220		60		10* 70	20 40	2 1 0.2 1	0.5 1.3	1 1	100	3	0.02	4E
D44C10	TO-220		80		10* 90	10 25	1 1 0.2 1	0.5 1.3	1 1	100	3	0.02	4F
D44C11	TO-220		80		10* 90	20 40	1 1 120 0.2 1	0.5 1.3	1 1	100	3	0.02	4E
D44C12	TO-220		80		10* 90	20 40	2 1 0.2 1	0.5 1.3	1 1	100	3	0.02	4E
D44H1	TO-220		30		10 30	20 35	4 1 2 1	1.0 1.5	8 8				4A
D44H2	TO-220		30		10 30	40 60	4 1 2 1	1.0 1.5	8 8				4A
D44H4	TO-220		45		10 45	20 35	4 1 2 1	1.0 1.5	8 8				4A
D44H5	TO-220		45		10 45	40 60	4 1 2 1	1.0 1.5	8 8				4A
D44H7	TO-220		60		10 60	20 35	4 1 2 1	1.0 1.5	8 8				4A
D44H8	TO-220		60		10 60	40 60	4 1 2 1	1.0 1.5	8 8				4A
D44H10	TO-220		80		10 80	20 35	4 1 2 1	1.0 1.5	8 8				4A
D44H11	TO-220		80		10 80	40 60	4 1 2 1	1.0 1.5	8 8				4A



**POWER (Continued)**

Type No.	Case Style	V <sub>CB0</sub> (V) Min	V <sub>CE0</sub> (V) Min	V <sub>EB0</sub> (V) Min	ICEX* I <sub>CEBT</sub> @ I <sub>CB0</sub> (μA) Max	V <sub>CB</sub> (V)	h <sub>FE</sub> Min Max	I <sub>C</sub> (A) @ V <sub>CE</sub> (V)	V <sub>CE(sat)</sub> (V) Max & V <sub>BE(sat)</sub> (V) Min	I <sub>C</sub> (A) @ V <sub>BE(sat)</sub> (V) Min	C <sub>ob</sub> (pF) Max	f <sub>T</sub> (MHz) Min Max	I <sub>C</sub> (A) @ Max	Process
MJE180	TO-126	40			0.1	60	12 30 50	1.5 0.5 0.1	0.3 0.9 1.7	0.500 1.5 2.0	30	50	0.05	37
MJE181	TO-126	60			0.1	80	12 30 50	1.5 0.5 0.1	0.3 0.9 1.7	0.500 1.5 2.0	30	50	0.1	38
MJE182	TO-126	80			0.1	100	12 30 50	1.5 0.5 0.1	0.3 0.9 1.7	0.500 1.5 2.0	30	50	0.05	39
MJE340	TO-126	300			100	300	30	240						36
MJE341	TO-126	150			300	175	20 25	0.15 0.05	1.0	0.05	15	15	0.05	36
MJE344	TO-126	200			100	200	20	0.01	2.3	0.15				36
MJE520	TO-126	30			100	30	30	0.05	1.0	0.05	15	15	0.05	36
MJE521	TO-126	40			100	40	40	1						2C
MJE720	TO-126	40			100*	40	8 20 40	1 0.5 0.15	0.15 0.4 1.0	0.15 0.5 1.3				37
MJE721	TO-126	60			100*	60	8 20 40	1 0.5 0.15	0.15 0.4 1.0	0.15 0.5 1.3				38
MJE722	TO-126	80			100*	80	8 20 40	1 0.5 0.15	0.15 0.4 1.0	0.15 0.5 1.3				39
MJE800	TO-126	60			200	60	750	1.5	2.5	1.5				2J
MJE801	TO-126	60			200	60	750	2	2.8	2				2J
MJE802	TO-126	80			200	80	750	1.5	2.5	1.5				2J
MJE803	TO-126	80			200	80	750	2	2.8	2				2J
MJE3439	TO-126	350			20	360	40	0.02	0.5	0.05	10	15	0.01	36
MJE3440	TO-126	250			20	250	40	0.02	0.5	0.05	10	15	0.01	36
MRF472	TO-126	30		3	10	50	10	0.4	2		70			35
NCB114	TO-126	60		4	0.1	30	75	0.05	0.4	0.5	10	125	0.05	14
NCB195	TO-126	65		3	10	40	30	0.1	0.5	1	35	120	0.1	35
NCB355	TO-220	65		3	10	40	30	0.1	0.5	1	35	120	0.1	35

# NPN Transistors



## POWER (Continued)

Type No.	Case Style	V <sub>CB0</sub> (V) Min	V <sub>CEO</sub> (V) Min	V <sub>EBO</sub> (V) Min	IC <sub>EX</sub> <sup>*</sup> IC <sub>EB1</sub> <sup>†</sup> IC <sub>BO</sub> (μA) Max	h <sub>FE</sub> @ IC (A) Min Max	IC & V <sub>CE</sub> (V) Max	V <sub>CE(sat)</sub> (V) Max	V <sub>BE(sat)</sub> (V) Min Max	IC (A) Max	C <sub>ob</sub> (pF) Max	f <sub>T</sub> (MHz) Min Max	IC (A) Max	Process
NSP41	TO-220		40		400	15 75	3 4	1.5		5		3	0.5	4E
						30	0.3 4	1.5		5		3	0.5	4E
NSP41A	TO-220		60		400	30	0.3 4							
NSP41B	TO-220		80		400	15 75	3 4	1.5		5		3	0.5	4E
						30	0.3 4							
NSP41C	TO-220		100		400	15 75	3 4	1.5		5		3	0.5	4E
						15	0.3 4							
NSP205	TO-220		50		100	25	2							4A
NSP520	TO-220		30		100	25	1							4F
NSP521	TO-220		40		100	40	1							4F
NSP575	TO-220	45	45		100	25	1	0.6		1		3	0.5	4F
NSP577	TO-220	60	60		100	25	1	0.6		1		3	0.5	4F
NSP579	TO-220	80	80		100	15	1	0.8		1		3	0.5	4F
NSP581	TO-220	100	100		100	15	1	0.8		1		3	0.5	4F
NSP585	TO-220	45	45		100	25	2	0.8		2		3	0.25	4E
						40	0.5 2							
NSP587	TO-220	60	60		100	25	2	0.8		2		3	0.25	4E
						40	0.5 2							
NSP589	TO-220	80	80		100	15	2	0.8		2		3	0.25	4E
						30	0.5 2							
NSP595	TO-220	45	45		100	25	3	1.0		3		3	0.25	4E
						40	1 2							
NSP597	TO-220	60	60		100	25	3	1.0		3		3	0.25	4E
						40	1 2							
NSP599	TO-220	80	80		100*	15	3	1.0		3		3	0.25	4E
						30	1 2							
NSP601	TO-220		100		100	15	3	1.0		3		3	0.25	4A
						30	1 2							
NSP695	TO-220		45		200	750	3	2.5		3				4J
NSP695A	TO-220		45		200	750	4	2.8		4				4J
NSP697	TO-220		60		200	750	3	2.5		3				4J
NSP697A	TO-220		60		200	750	4	2.8		4				4J
NSP699	TO-220		80		200	750	3	2.5		3				4J
NSP699A	TO-220		80		200	750	4	2.8		4				4J
NSP701	TO-220		100		200	750	3	2.5		3				4J





## POWER (Continued)

Type No.	Case Style	V <sub>CB0</sub> (V) Min	V <sub>CE0</sub> (V) Min	V <sub>EB0</sub> (V) Min	ICEX* IC <sub>EBT</sub> <sup>†</sup> IC <sub>B0</sub> (μA) Max	h <sub>FE</sub> @ IC & V <sub>CE</sub> (V) Min Max	V <sub>CE(sat)</sub> (V) Max & V <sub>BE(sat)</sub> (V) Min	IC @ (A) Min Max	C <sub>ob</sub> (pF) Max	f <sub>T</sub> (MHz) Min Max	IC @ (A) Min Max	Process
NSP2020	TO-220		40		400	15 25	1.0 1.5	3 4		3	0.5	4A
NSP2021	TO-220		60		400	15 20	1.0 1.5	3 4		3	0.5	4A
NSP2100	TO-220		60		200	750	2.5	3				4J
NSP2101	TO-220		60		200	750	2.5	4				4J
NSP2102	TO-220		80		200	750	2.5	3				4J
NSP2103	TO-220		80		200	750	2.5	4				4J
NSP2480	TO-220		40		100	20 40	1.4 0.7	1.5 4				4A
NSP2481	TO-220		60		100	20 40	1.4 0.7	1.5 4				4A
NSP2482	TO-220		40		100	20 40	1.4 0.7	1.5 4				4A
NSP2483	TO-220		60		100	20 40	1.4 0.7	1.5 4				4A
NSP2520	TO-220		40		200*	10 40	0.7	1 4				4F
NSP3054	Lead Bend + Clip TO-220		55		1 mA*	5 25	1.0 6.0	3 4			0.5 3	4E
NSP3055	TO-220		60		1 mA	5 20	1.0 8.0	10 4			0.5 10	4A
NSP4921	TO-220		40		100	10 40	0.6	1 0.05			1.3 1	4F
NSP4922	TO-220		60		100	10 20 40	0.6	1 0.5 0.05			1.3 1	4F
NSP4923	TO-220		80		100	10 20 40	0.6	1 0.5 0.05			1.3 1	4F
NSP5190	TO-220		40		100	10 25	0.6 1.4	4 1			1.5 4	4E
NSP5191	TO-220		60		100	10 25	0.6 1.4	4 1.5			1.5 4	4E

# NPN Transistors



## POWER (Continued)

Type No.	Case Style	V <sub>CB0</sub> (V) Min	V <sub>CE0</sub> (V) Min	V <sub>EB0</sub> (V) Min	I <sub>CEX</sub> <sup>*</sup> I <sub>CEB1</sub> I <sub>CS0</sub> ( $\mu$ A) Max	V <sub>CB</sub> (V) @ I <sub>C</sub> Max	h <sub>FE</sub> Min @ I <sub>C</sub> Max	V <sub>CE</sub> (V) & I <sub>C</sub> (A) @ I <sub>C</sub> Max	V <sub>CE(sat)</sub> (V) Max & I <sub>C</sub> (A) @ I <sub>C</sub> Max	V <sub>BE(sat)</sub> (V) Min @ I <sub>C</sub> Max	I <sub>C</sub> (A) @ I <sub>C</sub> Max	C <sub>ob</sub> (pF) Max	f <sub>T</sub> (MHz) Min @ I <sub>C</sub> Max	I <sub>C</sub> (A) @ I <sub>C</sub> Max	Process
NSP5192	TO-220		80		100	80	7 20	4 1.5 2	0.6 1.4		1.5 4				4E
NSP5977	TO-220		40		100*	60	7 20 40	5 2.5 0.5 2	1.7	2.5	5	200	2	0.5	4A
NSP5978	TO-220		60		100*	80	7 20 40	5 2.5 0.5 2	0.6	2.5	5	200	2	0.5	4A
NSP5979	TO-220		80		100*	100	7 20 40	5 2.5 0.5 2	0.6	2.5	5	200	2	0.5	4A
NSP5983	TO-220		40		100*	60	7 20 40	8 4 1 2	1.7	2.5	8	250	2	0.5	4A
NSP5984	TO-220		60		100*	80	7 20 40	8 4 1 2	0.6	2.5	8	250	2	0.5	4A
NSP5985	TO-220		80		100*	80	7 20 40	8 4 1 2	0.6	2.5	8	250	2	0.5	4A
TIP29	TO-220		40		200*	40	15 40	1 0.2 4	0.7		1		3	0.2	4F
TIP29A	TO-220		60		200*	60	15 40	1 0.2 4	0.7		1		3	0.2	4F
TIP29B	TO-220		80		200*	80	15 40	1 0.2 4	0.7		1		3	0.2	4F
TIP29C	TO-220		100		200*	100	15 40	1 0.2 4	0.7		1		3	0.2	4F
TIP31	TO-220		40		200*	40	10 25	3 1 4	1.2		3		3	0.5	4F
TIP31A	TO-220		60		200*	60	10 25	3 1 4	1.2		3		3	0.5	4F
TIP31B	TO-220		80		200*	80	10 25	3 1 4	1.2		3		3	0.5	4F
TIP31C	TO-220		100		200*	100	10 25	3 1 4	1.2		3		3	0.5	4F
TIP41	TO-220		40		400*	40	15 30	3 0.3 4	1.5		6		3	0.5	4A



POWER (Continued)

Type No.	Case Style	V <sub>CB0</sub> (V) Min	V <sub>CE0</sub> (V) Min	V <sub>EBO</sub> (V) Min	ICEX* IC <sub>EB1</sub> IC <sub>BO</sub> (μA) Max	h <sub>FE</sub> Min Max	IC (A) & VCE (V) Min Max	V <sub>CE(sat)</sub> (V) & V <sub>BE(sat)</sub> (V) Max Min	IC (A) @ Max	C <sub>ob</sub> (pF) Max	f <sub>T</sub> (MHz) Min Max	IC (A) @ Max	Process
TIP41A	TO-220	60	60		400*	15 30	3 4 0.3 4	1.5	6		3	0.5	4A
TIP41B	TO-220	80	80		400*	15 30	3 4 0.3 4	1.5	6		3	0.5	4A
TIP41C	TO-220	100	100		400*	15 30	3 4 0.3 4	1.5	6		3	0.5	4A
TIP61	TO-220	40	40		200*	15 40	0.5 4 0.05 4	0.7	0.5		3	0.05	4F
TIP61A	TO-220	60	60		200*	15 40	0.5 4 0.05 4	0.7	0.5		3	0.05	4F
TIP61B	TO-220	80	80		200*	15 40	0.5 4 0.05 4	0.7	0.5		3	0.05	4F
TIP61C	TO-220	100	100		200*	15 40	0.5 4 0.05 4	0.7	0.5		3	0.05	4F
TIP110	TO-220	60	60		1 mA	500 1000	2 4 1 4	2.5	2				4J
TIP111	TO-220	80	80		1 mA	500 1000	2 4 1 4	2.5	2				4J
TIP112	TO-220	100	100		1 mA	500 1000	2 4 1 4	2.5	2				4J
TIP120	TO-220	60	60		200	1000	3 3	2.0 4.0	3 5				4K
TIP121	TO-220	80	80		200	1000	3 3	2.0 4.0	3 5				4K
TIP122	TO-220	100	100		200	1000	3 3	2.0 4.0	3 5				4K
TIP130	TO-220	60	60		200	1000	4 4	2.0 3.0	4 6				4K
TIP131	TO-220	80	80		200	1000	4 4	2.0 3.0	4 6				4K
TIP132	TO-220	100	100		200	1000	4 4	2.0 3.0	4 6				4K

# NPN Transistors



**DARLINGTON**

Type No.	Case Style	V <sub>CE0</sub> (V) Min	V <sub>CE0</sub> (V) Min	V <sub>EB0</sub> (V) Min	I <sub>CE0</sub> * I <sub>CB0</sub> (mA) Max	I <sub>FE</sub> Min Max @ I <sub>C</sub> (mA)	V <sub>CE(SAT)</sub> & V <sub>BE(SAT)</sub> (V) Max Min	I <sub>C</sub> (mA) Max	C <sub>ob</sub> (pF) Max	f <sub>T</sub> (MHz) Min Max	I <sub>C</sub> (mA) Max	Process
2N5305	TO-92 (74)				100	2000 20,000	1.4	200	10	60	2	05
2N5306	TO-92 (74)				100	7000 70,000	1.4	200	10	60	2	05
2N5307	TO-92 (74)				100	2000 20,000	1.4	200	10	60	2	05
2N5308	TO-92 (74)				100	7000 70,000	1.4	200	10	60	2	05
92PU45	TO-92+ (91)		50	12	100	4000 15,000 25,000	1.5	1A 500 200		100	200	05
92PU45A	TO-92+ (91)		60	12	100	4000 15,000 25,000	1.5	1A 500 200		100	200	05
D40C1	TO-202 (35)		30		500*	10,000 60,000	1.5	200 500	10			05
D40C2	TO-202 (35)		30		500*	40,000	1.5	200 500	10			05
D40C3	TO-202 (35)		30		500*	90,000	1.5	200 500	10			05
D40C4	TO-202 (35)		40		500*	10,000 60,000	1.5	200 500	10			05
D40C5	TO-202 (35)		40		500*	40,000	1.5	200 500	10			05
D40C7	TO-202 (35)		50		500*	10,000 60,000	1.5	200 500	10			05
D40C8	TO-202 (35)		50		500*	40,000	1.5	200 500	10			05
MPFA12	TO-92 (72)		20		100	20,000	1.0	10				05
MPFA13	TO-92 (72)		30		100	10,000 5,000	1.5	100 10 5		125	10	05
MPFA14	TO-92 (72)		30		100	20,000 10,000	1.5	100 10 5		125	10	05



### DUAL DIFFERENTIAL AMPS

Type No.	Case Style	V <sub>CE0</sub> (V) Min	V <sub>CE0</sub> (V) Min	V <sub>EBO</sub> (V) Min	I <sub>CB0</sub> (nA) Max	HFE Min	HFE Max @ I <sub>C</sub> (mA)	HFE1 HFE2 (%) Max	V <sub>BE1</sub> -V <sub>BE2</sub> (mV) Max	$\frac{\Delta V_{EE1}}{-\Delta V_{EE2}} \frac{\Delta I_T}{\Delta I_C}$ ( $\mu V/\Sigma$ ) Max	C <sub>ob</sub> (pF) Max	f <sub>t</sub> (MHz) Min	f <sub>t</sub> (MHz) Max	NF (dB) Max	Test Condition	Process No.	
2N2453	TO-78	60	30	7	5	150	600 0.01	10	5	10	8	60		7	1	07	
2N2453A	TO-78	80	50	7	5	150	600 0.01	10	5	5	4	60		4	1	07	
2N2639	TO-78	45	45	5	10	65	1 0.1	10	5	10	8	80		4	2	07	
						55	300 0.01										
2N2640	TO-78	45	45	5	10	65	1 0.1	20	10	20	8	80		4	2	07	
						55	0.1										
2N2641	TO-78	45	45	5	10	65	1 0.01				8	80		4	2	07	
						55	0.1										
2N2642	TO-78	45	45	5	10	130	1 0.1	10	5	10	8	80		4	2	07	
						110	0.1										
2N2643	TO-78	45	45	5	10	130	1 0.1	20	10	20	8	80		4	2	07	
						110	0.1										
2N2644	TO-78	45	45	5	10	130	1 0.1				8	80		4	2	07	
						110	0.1										
2N2722	TO-78	45	45	5	1	120	0.1	10	5	20	6	100		4	2	07	
						100	0.01										
2N2903	TO-78	60	30	7	10	50	250 0.001	20	10	20	8	60		7	1	07	
						60	0.1										
2N2903A	TO-78	60	30	7	10	125	625 1	10	5	10	8	60		7	1	07	
						60	0.01										
2N2913	TO-78	45	45	6	10	150	1 0.1				6	60		4	1	07	
						100	0.1										
2N2914	TO-78	45	45	6	10	300	1 0.1				6	60		3	1	07	
						225	0.1										
						150	0.01										

**TEST CONDITIONS:**

(1) I<sub>C</sub> = 10  $\mu$ A, V<sub>CE</sub> = 5V, f = 1kHz. (2) I<sub>C</sub> = 10  $\mu$ A, V<sub>CE</sub> = 5V, f = 15.7kHz. (3) I<sub>C</sub> = 100  $\mu$ A, V<sub>CE</sub> = 5V, f = 1kHz.



# NPN Transistors



## DUAL DIFFERENTIAL AMPS (Continued)

Type No.	Case Style	V <sub>CB0</sub> (V) Min	V <sub>CEO</sub> (V) Min	V <sub>EB0</sub> (V) Min	I <sub>CB0</sub> (mA) Max	V <sub>CB</sub> (V) @ I <sub>C</sub>	I <sub>C</sub> (mA) @ HFE	HFE1 HFE2 (%) Max	V <sub>BE1</sub> -V <sub>BE2</sub> (mV) Max	ΔV <sub>EE1</sub> -V <sub>EE2</sub> ΔT (μV/Δ)	C <sub>ob</sub> (pF) Max	f <sub>t</sub> (MHz) Min Max	NF (dB) Max	Test Condition	Process No.
2N2915	TO-78	45	45	6	10	45	150 100 60 240	10	5 3 5	10	6	60	4	1	07
2N2915A	TO-78	45	45	6	10	45	150 100 60 240	10	2 1.5 2	5	6	60	4	1	07
2N2916	TO-78	45	45	6	10	45	300 225 150 600	10	3	10	6	60	3	1	07
2N2916A	TO-78	45	45	6	10	45	300 225 150 600	10	2 1.5 2	5	6	60	3	1	07
2N2917	TO-78	45	45	6	10	45	150 100 60 240	20	10 5 10	20	6	60	4	1	07
2N2918	TO-78	45	45	6	10	45	300 225 150 600	20	10 5 10	20	6	60	3	1	07
2N2919	TO-78	60	60	6	2	45	150 100 60 240	10	5 3 5	10	6	60	4	1	07
2N2919A	TO-78	60	60	6	2	45	150 100 60 240	10	2 1.5 2	5	6	60	4	1	07
2N2920	TO-78	60	60	6	2	45	300 225 150 600	10	5 3 5	10	6	60	3	1	07
2N2920 J, JTX, JTXV	TO-78	70	60	6	2	45	300 235 175 600	10	5 3 5	10	5	60	3	1	07
2N2920A	TO-78	60	60	6	2	45	300 225 150 600	10	2 1.5 2	5	6	60	3	1	07
2N2972	TO-71	45	45	6	10	45	150 100 60 240	1	1.5 2	6	6	60	4	1	07
2N2973	TO-71	45	45	6	10	45	300 225 150 600	1	1.5 2	6	6	60	3	1	07



DUAL DIFFERENTIAL AMPS (Continued)

Type No.	Case Style	V <sub>CE0</sub> (V) Min	V <sub>CE0</sub> (V) Max	V <sub>BE0</sub> (V) Min	I <sub>CB0</sub> (nA) Max	V <sub>CB</sub> (V)	HFE Min	HFE Max	I <sub>C</sub> (mA)	HFE1 HFE2 (%) Max	V <sub>BE1</sub> -V <sub>BE2</sub> (mV) Max	$\frac{\Delta V_{EE1}}{-V_{EE2}} \frac{\Delta T}{(\mu V/^\circ C)}$ Max	C <sub>ob</sub> (pF) Max	f <sub>t</sub> (MHz) Min	f <sub>t</sub> (MHz) Max	NF (dB) Max	Test Condition	Process No.
2N2974	TO-71	45	10	6	10	45	150	240	1	10	5	10	6	60		4	1	07
							100	240	0.1		3							
							60	240	0.01		5							
2N2975	TO-71	45	10	6	10	45	300	600	1	10	5	10	6	60		3	1	07
							225	600	0.1		3							
							120	600	0.01		5							
2N2976	TO-71	45	10	6	10	45	150	240	1	20	10	20	6	60		4	1	07
							100	240	0.1		5							
							60	240	0.01		10							
2N2977	TO-71	45	10	6	10	45	300	600	1	20	10	20	6	60		3	1	07
							225	600	0.1		5							
							120	600	0.01		10							
2N2978	TO-71	60	2	6	2	45	150	240	1	10	5	10	6	60		4	1	07
							100	240	0.1		3							
							60	240	0.01		5							
2N2979	TO-71	60	2	6	2	45	300	600	1	10	5	10	6	60		3	1	07
							225	600	0.1		3							
							120	600	0.01		5							
2N3587	TO-78	60	10	6	10	40	80	500	1	10	20	20	8	80	200	10	3	07
							50	500	0.1		20							
2N3580	TO-78	60	10	6	10	45	300	600	1	10	3	5	6	60	240	3	2	07
							225	600	0.1		10							
							150	600	0.01		3							
							80	600	0.001		5							
2N3907	TO-78	60	10	6	10	45	120	300	1	10	2.5	5	6	60	240	4	1	07
							70	300	0.1		1							
							60	300	0.01		2							
2N3908	TO-78	60	2	6	2	45	200	300	1	10	2.5	5	6	60	240	3	1	07
							125	300	0.1		1							
							100	300	0.01		1							
							40	300	0.001		1							

TEST CONDITIONS:

(1) I<sub>C</sub> = 10 μA, V<sub>CE</sub> = 5V, f = 1kHz. (2) I<sub>C</sub> = 10 μA, V<sub>CE</sub> = 5V, f = 15.7kHz. (3) I<sub>C</sub> = 100 μA, V<sub>CE</sub> = 5V, f = 1kHz.









Section 2

**PNP Transistors**

**2**

# PNP Transistors



## SATURATED SWITCHES

Type No.	Case Style	V <sub>CB0</sub> (V) Min	V <sub>CE0</sub> (V) Min	V <sub>EB0</sub> (V) Min	ICES* ICB0 (mA) Max	V <sub>CB</sub> (V) Max	hFE @ IC & VCE (V)		V <sub>CE(SAT)</sub> (V) Max	V <sub>BE(SAT)</sub> (V) Min Max		IC @ (mA)	Cob (pF) Max	f <sub>T</sub> (MHz) Min Max		t <sub>off</sub> (ns) Max	NF (dB) Max	Test Condition	Process No.
							Min	Max		Min	Max			Min	Max				
2N869	TO-52	25		5	10	15	20	120	10	5	1.0	1.0	9	100	10				64
2N869A	TO-52	25	18	5	10	15	25	120	100	5	0.15	0.78	6	400	10	80		1	64
							40	120	30	0.5									
							30	10	0.3										
							40	120	10	5	0.2	0.85							
2N995	TO-52	20	15	4	5	15	35	140	20	1	0.2	0.95	10	100	10	90		2	64
2N995A	TO-52	20	15	4	5	15	25	100	1	1	0.2	0.95	6	100	10				64
							25	50	1		0.5	1.7							
							25	20	1										
							35	140	1	1									
2N2894	TO-52	12	12	4	10*	6	25	100	1	1	0.15	0.78	6	400	30	90		2	64
							40	150	0.5	0.5	0.2	0.85							
							30	10	0.3		0.5	1.7							
2N2894A	TO-52	12	12	4.5	50*	10	30	100	1	1	0.13	0.78	4.5	800	30	25		3	64
							40	120	0.5	0.3	0.19	0.85							
							30	10	0.3		0.45	1							
							20	1	0.5										
2N3012	TO-52	12	12	4	80*	6	20	100	1	1	0.15	0.78	6	400	30	75		2	64
							30	120	0.5	0.5	0.2	0.85							
							25	10	0.3		0.5	1.7							
2N3209	TO-52	20	20	4	80*	10	15	100	1	1	0.15	0.78	5	400	30	90		2	64
							30	120	0.5	0.3	0.2	0.85							
							20	10	3		0.6	1.7							
2N3244	TO-39	40	40	5	50	30	25	750	5	5	0.3	1.1	25	175	50	185		4	70
							60	150	1	1	0.5	0.75							
2N3245	TO-39	50	50	5	50	50	20	1A	5	5	0.35	1.1	25	150	50	165		4	70
							30	90	500	1	0.6	0.75							
							35	150	1	1	1.2	2							
2N3248	TO-52	15	12	5			25	100	1	1	0.125	0.6	8	250	20	100		5	64
							35	50	1	1	0.25	0.7							
							50	10	1	1	0.25	1.1							
							50	1	1	1	0.4	1.3							
							50	150	0.1	1									
2N3249	TO-52	15	12	5			35	100	1	1	0.125	0.6	8	300	20	100		5	64
							75	50	1	1	0.25	0.7							
							100	10	1	1	0.25	1.1							
							100	1	1	1	0.45	1.3							
							100	300	0.1	1									



**SATURATED SWITCHES (Continued)**

Type No.	Case Style	V <sub>CEO</sub> (V) Min	V <sub>BE0</sub> (V) Min	I <sub>CS</sub> * I <sub>CB0</sub> @ I <sub>CA</sub> Max	I <sub>CE</sub> & V <sub>CE</sub> (mA) (V)	V <sub>CE(SAT)</sub> (V) Max	V <sub>BE(SAT)</sub> (V) Min	I <sub>C</sub> (mA) @ Max	C <sub>ob</sub> (pF) Max	f <sub>T</sub> (MHz) Min	I <sub>C</sub> (mA) @ Max	t <sub>off</sub> (ns) Max	NF (dB) Max	Test Condition	Process No.
2N3304	TO-52	6	4	10*	3	0.15	0.7	10	3.5	500	10	60		7	65
						0.16	0.8	1							
						0.5	1.5	50							
2N3451	TO-52	6	4	10*	3	0.16	0.8	10	5.5	500	10	60		7	65
						0.5	1.5	50							
2N3467	TO-39	40	5	100	30	0.3	1.0	150	25	175	50	90		4	70
						0.5	1.2	500							
2N3468	TO-39	50	5	100	30	0.35	1.0	150	25	150	50	90		4	70
						0.6	1.2	500							
2N3545	TO-52	20	5	10	10	0.2	0.6	100	8	250	10	90		8	64
						0.3	1.1	50							
						0.5	1.3	100							
2N3546	TO-52	15	4.5	10	10	0.15	0.7	100	6	700	10	30		9	64
						0.25	0.8	50							
						0.5	1.6	100							
2N3576	TO-52	20	5	10	15	0.15	0.75	100	4.5	400	10	50		5	64
						0.5	1.1	100							
2N3639	TO-92 (72)	Same as PN3639, see page 2-5 for explanation													
2N3640	TO-92 (72)	Same as PN3640, see page 2-5 for explanation													
2N4208	TO-52	12	4.5	10*	6	0.13	0.8	50	3	700	10	20		5	65
						0.15	0.8	10							
						0.5	1.5	50							
2N4209	TO-52	15	4.5	10*	8	0.15	0.8	50	3	850	10	20		5	65
						0.18	0.8	10							
						0.6	1.5	50							
2N4258	TO-92 (72)	Same as PN4258, see page 2-5 for explanation													
2N4258A	TO-92 (72)	Same as PN4258A, see page 2-5 for explanation													

**TEST CONDITIONS:**

(1) I<sub>C</sub> = 30mA, V<sub>CC</sub> = 3V, I<sub>B</sub><sup>1</sup> = 3mA, I<sub>B</sub><sup>2</sup> = 1.5mA. (2) I<sub>C</sub> = 30mA, V<sub>CC</sub> = 3V, I<sub>B</sub><sup>1</sup> = I<sub>B</sub><sup>2</sup> = 1.5mA. (3) I<sub>C</sub> = 30mA, V<sub>CC</sub> = 3V, I<sub>B</sub><sup>1</sup> = I<sub>B</sub><sup>2</sup> = 3mA. (4) I<sub>C</sub> = 500mA, V<sub>CC</sub> = 30V, I<sub>B</sub><sup>1</sup> = I<sub>B</sub><sup>2</sup> = 50mA.  
 (5) I<sub>C</sub> = 10mA, V<sub>CC</sub> = 3V, I<sub>B</sub><sup>1</sup> = I<sub>B</sub><sup>2</sup> = 1mA. (6) I<sub>C</sub> = 10mA, V<sub>CC</sub> = 1.5V, I<sub>B</sub><sup>1</sup> = I<sub>B</sub><sup>2</sup> = 1mA. (7) I<sub>C</sub> = 10mA, V<sub>CC</sub> = 1.5V, I<sub>B</sub><sup>1</sup> = I<sub>B</sub><sup>2</sup> = 500 μA. (8) I<sub>C</sub> = 10mA, V<sub>CC</sub> = 2V, I<sub>B</sub><sup>1</sup> = I<sub>B</sub><sup>2</sup> = 1mA. (9) I<sub>C</sub> = 50mA, V<sub>CC</sub> = 3V, I<sub>B</sub><sup>1</sup> = I<sub>B</sub><sup>2</sup> = 5mA. (10) I<sub>C</sub> = 1A, V<sub>CC</sub> = 30V, I<sub>B</sub><sup>1</sup> = I<sub>B</sub><sup>2</sup> = 100mA.



## SATURATED SWITCHES (Continued)

Type No.	Case Style	V <sub>CB0</sub> (V) Min	V <sub>CE0</sub> (V) Min	V <sub>EBO</sub> (V) Min	I <sub>CB0</sub> @ (mA) Max	V <sub>CB</sub> (V)	I <sub>CB0</sub> @ (mA) Max	I <sub>CE</sub> * (mA) Max	V <sub>CE(SAT)</sub> (V) Max	V <sub>BE(SAT)</sub> (V) Min	I <sub>C</sub> @ (mA) Max	C <sub>ob</sub> (pF) Max	f <sub>T</sub> (MHz) Min	I <sub>C</sub> @ (mA) Max	t <sub>off</sub> (ns) Max	NF (dB) Max	Test Condition	Process No.
2N5022	TO-39	50	50	5	100*	30	100*	1A, 5 25 100 15 100	0.2 0.4 0.8	1.0 1.4 1.75	100 500 1A	25	170	50	90		4	70
2N5023	TO-39	30	30	5	100*	20	100*	1A, 5 40 100 30 100	0.17 0.35 0.7	1.0 1.4 1.75	100 500 1A	25	200	50	90		4	70
2N5056	TO-52	15	15	4.5	50*	10	50*	100 1 30 100 20 10 12 1	0.13 0.19 0.45	0.72 0.92 1.5	10 4.5 30 30 1 100	4.5	600	30	35		3	64
2N5057	TO-52	15	15	4.5	50*	10	50*	100 1 40 100 30 10 20 1	0.13 0.19 0.45	0.72 0.92 1.5	10 4.5 30 30 1 100	4.5	800	30	35		3	64
2N5140	TO-92 (72)	Same as PN5140, see page 2-5 for explanation															65	
2N5771	TO-92 (72)	15	15	4.5	10	8	10	50 10 50 120 35 1	0.15 0.18 0.6	0.8 0.8 1.5	1 3 10 10 50 50	3	850	10	20		6	65
2N5910	TO-92 (72)	Same as PN5910, see page 2-5 for explanation															65	
DH3467CD	Ceramic DIP (40)	40	40	5	100	30	100	1A, 5 40 120 40 150	1.0 0.5 0.3	1.6 1.2 1.0	1A 25 500 500 150 150	25	175	50	90		4	70
DH3467CN	Molded DIP (39)	40	40	5	100	30	100	1A, 5 40 120 40 150	1.0 0.5 0.3	1.6 1.2 1.0	1A 25 500 500 150 150	25	175	50	90		4	70
DH3468CD	Ceramic DIP (40)	50	50	5	100	30	100	1A, 5 25 75 25 150	1.2 0.6 0.35	1.6 1.2 1.0	1A 25 500 500 150 150	25	150	50	90		4	70
DH3468CN	Molded DIP (39)	50	50	5	100	30	100	1A, 5 25 75 25 150	1.2 0.6 0.35	1.6 1.2 1.0	1A 25 500 500 150 150	25	150	50	90		4	70
MPS3639	TO-92 (72)	Same as PN3639, see page 2-5 for explanation															65	
MPS3640	TO-92 (72)	Same as PN3640, see page 2-5 for explanation															65	



### SATURATED SWITCHES (Continued)

Type No.	Case Style	V <sub>CE0</sub> (V) Min	V <sub>CEO</sub> (V) Min	VEBO (V) Min	IC <sub>BO</sub> * (mA) Max	V <sub>CB</sub> (V)	h <sub>FE</sub> @ I <sub>C</sub> & V <sub>CE</sub> (mA) (V)	V <sub>CE(SAT)</sub> (V) Max	V <sub>BE(SAT)</sub> (V) Min	I <sub>C</sub> (mA) @ I <sub>C</sub> Max	C <sub>ob</sub> (pF) Max	f <sub>T</sub> (MHz) Min	I <sub>C</sub> (mA) @ I <sub>C</sub> Max	t <sub>off</sub> (ns) Max	NF (dB) Max	Test Condition	Process No.	
NS3762	TO-39	40	40	5			30	0.9	1.4	1A	18	180	50	115		10	70	
							30	0.5	1.2	500								
							35	0.22	1.0	150								
							40	0.15	0.8	10								
NS3763	TO-39	60	60	5			20	0.9	1.4	1A	18	180	50	115		10	70	
							20	0.5	1.2	500								
							35	0.22	1.0	150								
							40	0.15	0.8	10								
PN3639	TO-92 (72)	6	6	4	10*	3	20	0.16	1.0	10	3.5	300	10	60		7	65	
							30	0.5	1.5	50								
							20	0.2	0.8	10	3.5	300	10	75				
							30	0.6	1.5	50								
PN4258	TO-92 (72)	12	12	4.5	10*	6	30	0.15	0.7	0.95	3	700	10	20		6	65	
							30	0.5	1.5	50								
							15	0.5	1.5	50								
							30	0.15	0.7	0.95	10	3	700	10	20			
PN4258A	TO-92 (72)	12	12	4.5	10*	6	30	0.15	0.7	0.95	3	700	10	18		6	65	
							30	0.5	1.5	50								
							15	0.5	1.5	50								
							30	0.15	0.7	0.95	10	3	700	10	18			
PN5140	TO-92 (72)	5	5	4	50*	3	20	0.2	1.2	10	5	400	10	20		6	65	
							30	0.75	1.5	50								
PN5910	TO-92 (72)	20	20	4.5	10*	10	30	0.15	0.75	0.95	3	700	10	20		6	65	
							30	0.15	0.75	0.95	10	3	700	10	20			

#### TEST CONDITIONS:

(1) I<sub>C</sub> = 30mA, V<sub>CC</sub> = 3V, I<sub>B1</sub> = 3mA, I<sub>B2</sub> = 1.5mA. (2) I<sub>C</sub> = 30mA, V<sub>CC</sub> = 3V, I<sub>B1</sub> = I<sub>B2</sub> = 1.5mA. (3) I<sub>C</sub> = 30mA, V<sub>CC</sub> = 3V, I<sub>B1</sub> = I<sub>B2</sub> = 3mA. (4) I<sub>C</sub> = 500mA, V<sub>CC</sub> = 30V, I<sub>B1</sub> = I<sub>B2</sub> = 50mA. (5) I<sub>C</sub> = 10mA, V<sub>CC</sub> = 3V, I<sub>B1</sub> = I<sub>B2</sub> = 1mA. (6) I<sub>C</sub> = 10mA, V<sub>CC</sub> = 1.5V, I<sub>B1</sub> = I<sub>B2</sub> = 1mA. (7) I<sub>C</sub> = 10mA, V<sub>CC</sub> = 1.5V, I<sub>B1</sub> = I<sub>B2</sub> = 500 μA. (8) I<sub>C</sub> = 10mA, V<sub>CC</sub> = 2V, I<sub>B1</sub> = I<sub>B2</sub> = 1mA. (9) I<sub>C</sub> = 50mA, V<sub>CC</sub> = 3V, I<sub>B1</sub> = I<sub>B2</sub> = 5mA. (10) I<sub>C</sub> = 1A, V<sub>CC</sub> = 30V, I<sub>B1</sub> = I<sub>B2</sub> = 100mA.

# PNP Transistors



## LOW LEVEL AMPS

Type No.	Case Style	VCBO (V) Min	VCEO (V) Min	VEBO (V) Min	ICBO (nA) Max	VCB (V)	$\beta_{FE}$ Min	$\beta_{FE}$ Max	IC @ (mA)	VCE & VCE (V)	VCE(SAT) (V) Max	VBE(SAT) (V) Min	IC @ (mA) Max	Cob (pF) Max	ft (MHz) Min	ft (MHz) Max	IC (mA) Max	NF (dB) @ (kHz) Max	Freq (kHz) Max	Process No.
2N2604	TO-46	60	45	6	10	45	350	10	5	5	0.5	0.7	0.9	10	30	30	0.5	4	1	62
2N2604 J, JTX, JTXV	TO-46	80	60	6	10	50	60	350	10	5	0.5	0.7	0.9	10	30	140	0.5	3	1	62
2N2605	TO-46	60	45	6	10	45	600	10	5	5	0.5	0.7	0.9	10	30	30	0.5	3	1	62
2N2605 J, JTX, JTXV	TO-46	70	60	6	10	50	150	300	0.01	5	0.5	0.7	0.9	10	30	140	0.5	3	1	62
2N3547	TO-18	60	60	6	25	45	75	10	5	5	1.0	1.0	1.0	10	45	45	1	5	1	62
2N3540	TO-18	60	45	6	10	45	600	10	5	5	1.0	1.0	1.0	10	60	150	1	4	1	62
2N3548	TO-18	60	60	6	10	45	200	1	5	5	1.0	1.0	1.0	10	60	150	1	4	1	62
2N3550	TO-18	60	45	8	1	45	150	0.1	5	5	0.5	0.7	0.9	5	60	150	1	4	1	62
2N3799	TO-18	60	60	5	10	50	300	900	0.1	5	0.25	0.8	1	4	30	30	0.5	1.5	1	62
2N3962	TO-18	60	60	6	10	50	300	0.1	5	5	0.2	0.7	0.1	5	40	160	0.5	3	1	62
							225	0.01	5	5										
							75	0.001	5	5										
							90	50	5	5										
							100	10	5	5	0.4	0.95	50							
							100	450	1	5										
							100	300	0.1	5										
							60	0.001	5	5										



LOW LEVEL AMPS (Continued)

Type No.	Case Style	V <sub>CE0</sub> (V)		V <sub>BE0</sub> (V)	I <sub>CB0</sub> (mA)	V <sub>CB</sub> (V)	h <sub>FE</sub>		I <sub>C</sub> (mA) & V <sub>CE</sub> (V)	V <sub>CE(SAT)</sub> (V) & V <sub>BE(SAT)</sub> (V)		I <sub>C</sub> (mA)	f <sub>T</sub> (MHz)		I <sub>C</sub> (mA)	NF (dB) @ Max	Freq (kHz)	Process No.
		Min	Max				Min	Max		Min	Max		Min	Max				
2N3963	TO-18	80	80	6	10	70	90	50	5	0.25	0.9	10	40	160	0.5	3	1	62
							100	10	5	0.4	0.95	50						
							100	1	5									
2N3964	TO-18	45	45	6	10	40	180	50	5	0.25	0.9	10	50	160	0.5	2	1	62
							200	10	5	0.4	0.95	50						
							250	1	5									
2N3965	TO-18	60	60	6	10	50	180	50	5	0.25	0.9	10	50	160	0.5	2	1	62
							200	10	5	0.4	0.95	50						
							250	1	5									
2N4058	TO-92 (74)	30	30	6	100	20	100	0.1	5	0.7		10				5	1	62
							200	10	5									
							250	1	5									
2N4059	TO-92 (74)	30	30	6	100	20	45	660	1	0.7		10						62
							90	330	1	0.7		10						
							180	660	1	0.7		10						
2N4061	TO-92 (74)	30	30	6	100	20	90	330	1	0.7		10						62
							180	660	1	0.7		10						
							250	500	0.01	0.7		10						
2N4062	TO-92 (74)	30	30	6	100	20	180	660	1	0.7		10						62
							250	500	0.001	0.7		10						
							300	660	0.1	0.7		10						
2N4248	TO-92 (72)	Same as PN4248, see page 2-8 for explanation																
2N4249	TO-92 (72)	Same as PN4249, see page 2-8 for explanation																
2N4250	TO-92 (72)	Same as PN4250, see page 2-8 for explanation																
2N4250A	TO-92 (72)	Same as PN4250A, see page 2-8 for explanation																
2N4288	TO-92 (74)	30	25	6	50	25	75	10	5	0.35	0.8	1	40		1			62
							150	1	5									
							100	0.1	5									
2N4289	TO-92 (74)	60	45	7	10	45	75	10	5	0.35	0.8	1	40		1			62
							150	1	5									
							100	0.1	5									

# PNP Transistors

## LOW LEVEL AMPS (Continued)

Type No.	Case Style	VCBO (V) Min	VCEO (V) Min	VEBO (V) Min	ICBO (nA) Max	VCB (V)	hFE Min	IC @ (mA) Max	VCE (V)	VCE(SAT) (V) Max	VBE(SAT) (V) Min	IC @ (mA) Max	Cob (pF) Max	fT (MHz) Min	fT (MHz) Max	IC (mA) Max	NF (dB) @ (kHz) Max	Freq (kHz)	Process No.	
2N4964	TO-92 (72)	Same as MPSA70, see below for explanation																		
2N4965	TO-92 (72)	Same as 2N5086, see below for explanation																		
2N5086	TO-92 (72)	50	50		50	35	150	10	5	0.3		10	4	40		0.5	3	1	62	
							150	1	5											
							150	500	0.1											
2N5087	TO-92 (72)	50	50		50	35		10	5	0.3		10	4	40		0.5	2	1	62	
							1	5												
							0.1	5												
2N5227	TO-92 (72)	30	30	3	100	10	50	700	2	0.4	1.0	10	5	100		10			62	
							30	0.1	10											
MPSA70	TO-92 (72)		40	4	100	30	40	400	5	0.25		10	4	125		5			62	
MPS6523	TO-92 (72)		25	4	50	20	300	600	2	0.5		50	4						62	
							150	0.1	10											
PN4248	TO-92 (72)	40	40	5	10	40	50	0.1	5	0.25		10	6						62	
PN4249	TO-92 (72)	60	60	5	10	40	100	300	0.1	0.25		10	6						62	
PN4250	TO-92 (72)	40	40	5	10	40	250	700	0.1	0.25		10	6						62	
PN4250A	TO-92 (72)	60	60	5	10	50	250	700	0.1	0.25		10	6						62	

## GENERAL PURPOSE AMPS AND SWITCHES

Type No.	Case Style	VCBO (V) Min	VCEO (V) Min	VEBO (V) Min	ICBO (nA) Max	VCB (V)	hFE Min	IC @ (mA) Max	VCE (V)	VCE(SAT) (V) Max	VBE(SAT) (V) Min	IC @ (mA) Max	Cob (pF) Max	fT (MHz) Min	fT (MHz) Max	IC (mA) Max	t <sub>off</sub> (ns) Max	NF (dB) Min	Test Condition	Process No.
2N722	TO-18	50	35	5	100	30	30	90	150	10	1.5	1.3	150	45	60	50				63
							25	5	10											
2N1132	TO-5	50	35	2	100	30	30	90	150	10	1.5	1.3	150	45	60	50				63
							25	5	10											
2N2696	TO-18	25	25		25	10	20	300	2	0.25	1.1	50	20	100	170	50			1	63
							30	130	50	1.0	2.0	300								





GENERAL PURPOSE AMPS AND SWITCHES (Continued)

Type No.	Case Style	V <sub>CEO</sub> (V) Min	V <sub>CE0</sub> (V) Min	V <sub>EBO</sub> (V) Min	I <sub>CBO</sub> (mA) Max	V <sub>CB</sub> (V) Max	h <sub>FE</sub> @ I <sub>C</sub> & V <sub>CE</sub> (V)		V <sub>CE(SAT)</sub> & V <sub>BE(SAT)</sub> (V) Max Min	I <sub>C</sub> (mA) @ Max	C <sub>ob</sub> (pF) Max	f <sub>T</sub> (MHz) Min Max		t <sub>off</sub> (ns) Max	NF (dB) Min	Test Condition	Process No.
							Min	Max				Min	Max				
2N2904	TO-5	60	40	5	20	50	20 40	500 150	10 10	0.4 1.6	150 500	8	200	100		2	63
2N2904 J, JTX, JTXV	TO-5	60	40	5	20	50	20 40	500 150	10 10	0.4 1.6	150 500	8	200	175		2	63
2N2904A	TO-5	60	60	5	10	50	40 40	500 150	10 10	0.4 1.6	150 500	8	200	100		2	63
2N2904A J, JTX, JTXV	TO-5	60	60	5	10	50	40 40	500 150	10 10	0.4 1.6	150 500	8	200	175		2	63
2N2905	TO-5	60	40	5	20	50	30 100	500 150	10 10	0.4 1.6	150 500	8	200	100		2	63
2N2905 J, JTX, JTXV	TO-5	60	40	5	20	50	75 50	300 150	10 10	0.4 1.6	150 500	8	200	200		2	63
2N2905A	TO-5	60	60	5	10	50	35 100	500 150	10 10	0.4 1.6	150 500	8	200	100		2	63
2N2905A J, JTX, JTXV	TO-5	60	60	5	10	50	50 75	300 150	10 10	0.4 1.6	150 500	8	200	100		2	63

TEST CONDITIONS:

(1) I<sub>C</sub> = 300mA, V<sub>CC</sub> = 10V, I<sub>B</sub><sup>1</sup> = I<sub>B</sub><sup>2</sup> = 30mA, V<sub>CE</sub> = 6V, I<sub>B</sub><sup>1</sup> = I<sub>B</sub><sup>2</sup> = 15mA, (2) I<sub>C</sub> = 150mA, V<sub>CC</sub> = 30mA, V<sub>CE</sub> = 5V, f = 100Hz, (7) I<sub>C</sub> = 30 μA, V<sub>CE</sub> = 5V, f = 1kHz, (8) I<sub>C</sub> = 100 μA, V<sub>CE</sub> = 5V, f = 1kHz, (9) I<sub>C</sub> = 250 μA, V<sub>CE</sub> = 5V, f = 1kHz, (10) I<sub>C</sub> = 10 μA, V<sub>CE</sub> = 5V, f = 1kHz, (11) I<sub>C</sub> = 50mA, V<sub>CC</sub> = 30V, I<sub>B</sub><sup>1</sup> = I<sub>B</sub><sup>2</sup> = 5mA, (12) I<sub>C</sub> = 150mA, V<sub>CC</sub> = 30V, I<sub>B</sub><sup>1</sup> = I<sub>B</sub><sup>2</sup> = 15mA, (13) I<sub>C</sub> = 50mA, V<sub>CC</sub> = 10V, I<sub>B</sub><sup>1</sup> = I<sub>B</sub><sup>2</sup> = 5mA, (4) I<sub>C</sub> = 300mA, V<sub>CC</sub> = 30V, I<sub>B</sub><sup>1</sup> = I<sub>B</sub><sup>2</sup> = 30mA, (5) I<sub>C</sub> = 10mA, V<sub>CC</sub> = 3V, I<sub>B</sub><sup>1</sup> = I<sub>B</sub><sup>2</sup> = 1mA, (6) I<sub>C</sub> = 100 μA, V<sub>CE</sub> = 5V, f = 1kHz, (14) I<sub>C</sub> = 100 μA, V<sub>CE</sub> = 5V, f = 1kHz, (15) I<sub>C</sub> = 250 μA, V<sub>CE</sub> = 5V, f = 1kHz.





GENERAL PURPOSE AMPS AND SWITCHES (Continued)

Type No.	Case Style	V <sub>CE0</sub> (V) Min	V <sub>BE0</sub> (V) Min	I <sub>CEO</sub> (nA) Max	V <sub>CB</sub> (V)	h <sub>FE</sub> Min	I <sub>C</sub> @ V <sub>CE</sub> (mA)	V <sub>CE(SAT)</sub> (V) Max	V <sub>BE(SAT)</sub> (V)		I <sub>C</sub> (mA) Max	C <sub>ob</sub> (pF) Max	f <sub>T</sub> (MHz)		t <sub>off</sub> (ns) Max	NF (dB) Min	Test Condition	Process No.
									Max	Min			Min	Max				
2N2907A J, JTX, JTXV	TO-18	60	5	10	50	50	500	0.4	1.3	150	8	200	50	200	2			63
2N3072	TO-5	60	4	10*	30	15	300	0.25	1.2	50	10	100	50	130	100			63
2N3073	TO-18	60	4	10*	30	15	300	0.25	1.2	50	10	100	50	130	100			63
2N3120	TO-5	45	4	10*	30	15	300	0.25	1.2	50	10	100	50	130	100			63
2N3121	TO-18	45	4	10*	30	15	300	0.25	1.2	50	10	100	50	130	100			63
2N3133	TO-5	50	4	50	30	10	150	0.6	1.5	150	10	150	50	200	150			63
2N3134	TO-5	50	4	50	30	25	150	0.6	1.5	150	10	150	50	200	150			63
2N3135	TO-18	50	4	50	30	25	150	0.6	1.5	150	10	150	50	200	150			63
2N3136	TO-18	50	4	50	30	25	150	0.6	1.5	150	10	150	50	200	157			63
2N3250	TO-18	50	5	50	30	15	50	0.25	0.6	9	10	6	250	10	225	6	5/6	69
2N3250A	TO-18	60	5	50	30	15	50	0.25	0.6	9	10	6	250	10	225	6	5/6	69

TEST CONDITIONS:

(1) I<sub>C</sub> = 300mA, V<sub>CC</sub> = 10V, I<sub>B</sub><sup>1</sup> = I<sub>B</sub><sup>2</sup> = 30mA. (2) I<sub>C</sub> = 150mA, V<sub>CC</sub> = 6V, I<sub>B</sub><sup>1</sup> = I<sub>B</sub><sup>2</sup> = 15mA. (3) I<sub>C</sub> = 300mA, V<sub>CC</sub> = 15V, I<sub>B</sub><sup>1</sup> = I<sub>B</sub><sup>2</sup> = 30mA. (4) I<sub>C</sub> = 300mA, V<sub>CC</sub> = 30V, I<sub>B</sub><sup>1</sup> = I<sub>B</sub><sup>2</sup> = 30mA.  
 (5) I<sub>C</sub> = 10mA, V<sub>CC</sub> = 3V, I<sub>B</sub><sup>1</sup> = I<sub>B</sub><sup>2</sup> = 1mA. (6) I<sub>C</sub> = 100 μA, V<sub>CE</sub> = 5V, f = 100kHz. (7) I<sub>C</sub> = 30 μA, V<sub>CE</sub> = 5V, f = 1kHz. (8) I<sub>C</sub> = 100 μA, V<sub>CE</sub> = 5V, f = 1kHz. (9) I<sub>C</sub> = 250 μA, V<sub>CE</sub> = 5V, f = 1kHz. (10) I<sub>C</sub> = 10 μA, V<sub>CE</sub> = 5V, f = 1kHz. (11) I<sub>C</sub> = 50mA, V<sub>CC</sub> = 30V, I<sub>B</sub><sup>1</sup> = I<sub>B</sub><sup>2</sup> = 5mA. (12) I<sub>C</sub> = 150mA, V<sub>CC</sub> = 30V, I<sub>B</sub><sup>1</sup> = I<sub>B</sub><sup>2</sup> = 15mA. (13) I<sub>C</sub> = 50mA, V<sub>CC</sub> = 10V, I<sub>B</sub><sup>1</sup> = I<sub>B</sub><sup>2</sup> = 5mA.



## GENERAL PURPOSE AMPS AND SWITCHES (Continued)

Type No.	Case Style	V <sub>CB0</sub> (V) Min	V <sub>CE0</sub> (V) Min	V <sub>EB0</sub> (V) Min	I <sub>CB0</sub> (mA) @ Max	V <sub>CB</sub> (V)	h <sub>FE</sub> @ I <sub>C</sub> & V <sub>CE</sub> Min Max (mA) (V)	V <sub>CE(SAT)</sub> (V)		V <sub>BE(SAT)</sub> (V) @ I <sub>C</sub> (mA)		C <sub>ob</sub> (pF) Max	f <sub>T</sub> (MHz) Min Max		I <sub>C</sub> (mA) @ Min Max	t <sub>off</sub> (ns) Max	NF (dB) Min	Test Condition	Process No.	
								Max	Min	Max	Min		Min	Max						Min
2N3250A J, JTX, JTXV	TO-18	60	60	5			15	50	1	0.2	0.6	0.9	10	6	250	10	225	6	5/6	69
							50	150	10	1	45	1	1	0.5	1.2	50				
2N3251	TO-18	50	40	5			30	50	1	0.25	0.6	0.9	10	6	300	20	250	6	5/6	69
							100	300	10	1	90	1	1	0.5	1.2	50				
2N3251A	TO-18	60	60	5			30	50	1	0.25	0.6	0.9	10	6	300	10	250	6	5/6	69
							100	300	10	1	90	1	1	0.5	1.2	50				
2N3251A J, JTX, JTXV	TO-18	60	60	5			30	50	1	0.25	0.6	0.9	10	6	300	10	250	6	5/6	69
							100	300	10	1	90	1	1	0.5	1.2	50				
2N3502	TO-5	45	45	5	10	30	50	500	10	0.25	1.0	50	8	200	50	100	4	4/7	63	
							100	300	150	10	140	10	10	0.4	1.3	150				
2N3503	TO-5	60	60	5	10	50	50	500	10	0.25	1	50	8	200	50	100	4	4/7	63	
							140	10	10	0.4	1.3	150								
2N3504	TO-18	45	45	5	10	30	50	500	10	0.25	1	50	8	200	50	100	4	4/7	63	
							100	300	150	10	140	10	10	0.4	1.3	150				
2N3505	TO-18	60	60	5	10	50	50	500	10	0.25	1	50	8	200	50	100	4	4/7	63	
							115	300	50	1	140	10	10	0.4	1.3	150				
2N3638	TO-92 (72)						100	300	150	10	0.25	1	50	8	200	50	100	4	4/7	63
							140	10	10	0.4	1.3	150								

Same as PN3638, see page 2-16 for explanation



GENERAL PURPOSE AMPS AND SWITCHES (Continued)

Type No.	Case Style	V <sub>CEO</sub> (V) Min	V <sub>BE0</sub> (V) Min	I <sub>CBO</sub> (mA) Max	V <sub>CB</sub> (V)	h <sub>FE</sub> @ I <sub>C</sub> & V <sub>CE</sub> Min Max	V <sub>CE(SAT)</sub> (V) Max	V <sub>BE(SAT)</sub> (V) Min	I <sub>C</sub> (mA) Max	C <sub>ob</sub> (pF) Max	f <sub>T</sub> (MHz) Min Max	I <sub>C</sub> (mA) Max	t <sub>off</sub> (ns) Max	NF (dB) Min	Test Condition	Process No.	
2N3638A	TO-92 (72)	Same as PN3638A, see page 2-17 for explanation															63
2N3644	TO-92 (72)	Same as PN3644, see page 2-17 for explanation															63
2N3702	TO-92 (74)	40	5	100	20	60	300	5	0.25	12	100	50				63	
2N3703	TO-92 (74)	50	5	100	20	30	150	5	0.25	12	100	50				63	
2N3905	TO-92 (72)	40	5			15	100	1	0.25	4.5	200	10	260	5	5/8	66	
						30	50	1	0.4								
						50	150	1									
						40	1	1									
						30	0.1	1									
2N3906	TO-92 (72)	40	5			30	100	1	0.25	4.5	250	10	300	4	5/8	66	
						60	50	1	0.4								
						100	300	1									
						80	1	1									
						60	0.1	1									
2N4121	TO-92 (72)	Same as PN4121, see page 2-17 for explanation															66
2N4122	TO-92 (72)	Same as PN4122, see page 2-17 for explanation															66
2N4125	TO-92 (72)	30	4	50	20	25	50	1	0.4	4.5	200	10		5	8	66	
						50	150	2									
2N4126	TO-92 (72)	25	4	50	20	60	50	1	0.4	4.5	250	10		4	8	66	
						120	360	2									
2N4142	TO-92 (72)	Same as PN4142, see page 2-17 for explanation															63
2N4143	TO-92 (72)	Same as PN4143, see page 2-17 for explanation															63
2N4290	TO-92 (74)	30	5	500	20	50	300	10	0.4	10	100	10				63	
						40	10	10									
						20	0.1	10									

TEST CONDITIONS:

(1) I<sub>C</sub> = 300mA, V<sub>CC</sub> = 10V, I<sub>B</sub><sup>1</sup> = I<sub>B</sub><sup>2</sup> = 30mA. (2) I<sub>C</sub> = 150mA, V<sub>CC</sub> = 6V, I<sub>B</sub><sup>1</sup> = I<sub>B</sub><sup>2</sup> = 15mA. (3) I<sub>C</sub> = 300mA, V<sub>CC</sub> = 15V, I<sub>B</sub><sup>1</sup> = I<sub>B</sub><sup>2</sup> = 30mA. (4) I<sub>C</sub> = 300mA, V<sub>CC</sub> = 30V, I<sub>B</sub><sup>1</sup> = I<sub>B</sub><sup>2</sup> = 30mA.  
 (5) I<sub>C</sub> = 10mA, V<sub>CC</sub> = 3V, I<sub>B</sub><sup>1</sup> = I<sub>B</sub><sup>2</sup> = 1mA. (6) I<sub>C</sub> = 100 μA, V<sub>CE</sub> = 5V, f = 1kHz. (7) I<sub>C</sub> = 30 μA, V<sub>CE</sub> = 5V, f = 1kHz. (8) I<sub>C</sub> = 100 μA, V<sub>CE</sub> = 5V, f = 1kHz. (9) I<sub>C</sub> = 250 μA, V<sub>CE</sub> = 5V, f = 1kHz. (10) I<sub>C</sub> = 10 μA, V<sub>CE</sub> = 5V, f = 1kHz. (11) I<sub>C</sub> = 50mA, V<sub>CC</sub> = 30V, I<sub>B</sub><sup>1</sup> = I<sub>B</sub><sup>2</sup> = 5mA. (12) I<sub>C</sub> = 150mA, V<sub>CC</sub> = 30V, I<sub>B</sub><sup>1</sup> = I<sub>B</sub><sup>2</sup> = 15mA. (13) I<sub>C</sub> = 50mA, V<sub>CC</sub> = 10V, I<sub>B</sub><sup>1</sup> = I<sub>B</sub><sup>2</sup> = 5mA.

## GENERAL PURPOSE AMPS AND SWITCHES (Continued)

Type No.	Case Style	V <sub>CB0</sub> (V) Min	V <sub>CE0</sub> (V) Min	V <sub>EB0</sub> (V) Min	I <sub>CB0</sub> (mA) @ V <sub>CB</sub> (V) Max	h <sub>FE</sub> @ I <sub>C</sub> & V <sub>CE</sub> (V) Min Max	V <sub>CE(SAT)</sub> (V) & V <sub>BE(SAT)</sub> (V)		I <sub>C</sub> (mA) @ V <sub>CE(SAT)</sub> (V)		C <sub>ob</sub> (pF) Max	f <sub>T</sub> (MHz)		I <sub>C</sub> (mA) Max	t <sub>off</sub> (ns) Max	NF (dB) Min	Test Condition	Process No.
							Max	Min	Max	Min		Max	Min					
2N4291	TO-92 (74)	40	30	6	200	100 300	0.4	1.5	100	10	10	100	10					63
2N4402	TO-92 (72)	40	40	5		20 500	0.4	0.7	150	20	10	150	20	255			4	63
2N4403	TO-92 (72)	40	40	5		100 300	0.4	0.75	150	20	10	200	20	255			4	63
2N4916	TO-92 (72)	Same as PN4916, see page 2-18 for explanation																
2N4917	TO-92 (72)	Same as PN4917, see page 2-18 for explanation																
2N4971	TO-92 (72)	Same as PN2906, see page 2-16 for explanation																
2N4972	TO-92 (72)	Same as PN2907, see page 2-16 for explanation																
2N5138	TO-92 (72)	Same as PN5138, see page 2-18 for explanation																
2N5139	TO-92 (72)	Same as PN5139, see page 2-18 for explanation																
2N5142	TO-92 (72)	Same as PN5142, see page 2-18 for explanation																
2N5143	TO-92 (72)	Same as PN5143, see page 2-18 for explanation																
2N5221	TO-92 (72)	15	15	3	100	30 600	0.5	1.1	150	20	15	100	20					63
2N5226	TO-92 (72)	25	25	4	300	30 600	0.8	1.0	100	20	20	50	20					63
2N5356	TO-92 (74)	25	25	4	100	40 120	0.25		50	8	8							63
2N5355	TO-92 (74)	25	25	4	100	100 300	0.25		50	8	8							63
2N5365	TO-92 (74)	40	40	4	100	20 300	0.25	1.1	50	8	8							63
						32 2	1.0	2.0	300									63



**GENERAL PURPOSE AMPS AND SWITCHES (Continued)**

Type No.	Case Style	V <sub>CEO</sub> (V) Min	V <sub>CE0</sub> (V) Min	V <sub>EB0</sub> (V) Min	I <sub>CB0</sub> (nA) Max	V <sub>CB</sub> (V)	h <sub>FE</sub> Min	I <sub>C</sub> & V <sub>CE</sub> Max (mA) & (V)	V <sub>CE(SAT)</sub> & V <sub>BE(SAT)</sub> (V) & (V)		I <sub>C</sub> @ (mA)	C <sub>ob</sub> (pF) Max	f <sub>T</sub> (MHz)		I <sub>C</sub> (mA)	t <sub>off</sub> (ns) Max	NF (dB) Min	Test Condition	Process No.	
									Max	Min			Min	Max						Min
2N5366	TO-92 (74)	40	40	4	100	40	40	300 50	0.25 1.1	50	8								63	
2N5400	TO-92 (72)	130	120	5	100	100	40	50 5	0.2 1.0	10	6			100	400	10			74	
2N5401	TO-92 (72)	160	150	5	50	120	50	50 5	0.2 1.0	10	6			100	300	10			74	
2N5817	TO-92 (77)	50	40	5	100	25	50	240 1	0.5 1.0	50	15			100		50			63	
EN2907	TO-92 (72)	Same as PN2907, see page 2-16 for explanation																		
MPSL51	TO-92 (72)	100	100	4	1	50	40	250 50	0.25 0.3	10	8			60	10				74	
MPS3638	TO-92 (72)	Same as PN3638, see page 2-16 for explanation																		
MPS3638A	TO-92 (72)	Same as PN3638A, see page 2-17 for explanation																		
MPS3644	TO-92 (72)	Same as PN3644, see page 2-17 for explanation																		
MPS3645	TO-92 (72)	Same as PN3645, see page 2-17 for explanation																		
MPS3702	TO-92 (72)	40	25	5	100	20	60	300 50	0.25	50	12			100		50			63	
MPS3703	TO-92 (72)	50	30	5	100	20	30	150 50	0.25	50	12			100		50			63	
MPS6516	TO-92 (72)	40	40	4	50	30	30	100 2	0.5	50	4								66	
MPS6517	TO-92 (72)	40	40	4	50	30	60	100 2	0.5	50	4								66	
MPS6518	TO-92 (72)		40	4	500	30	90	100 2	0.5	50	4								66	
MPS6522	TO-92 (72)		25	4	50	20	200	400 0.1	0.5	50	4							3	10	66

**TEST CONDITIONS:**

(1) I<sub>C</sub> = 300mA, V<sub>CC</sub> = 10V, I<sub>B</sub><sup>1</sup> = I<sub>B</sub><sup>2</sup> = 30mA. (2) I<sub>C</sub> = 150mA, V<sub>CC</sub> = 6V, I<sub>B</sub><sup>1</sup> = I<sub>B</sub><sup>2</sup> = 15mA. (3) I<sub>C</sub> = 300mA, V<sub>CC</sub> = 15V, I<sub>B</sub><sup>1</sup> = I<sub>B</sub><sup>2</sup> = 30mA. (4) I<sub>C</sub> = 300mA, V<sub>CC</sub> = 30V, I<sub>B</sub><sup>1</sup> = I<sub>B</sub><sup>2</sup> = 30mA.  
 (5) I<sub>C</sub> = 10mA, V<sub>CC</sub> = 3V, I<sub>B</sub><sup>1</sup> = I<sub>B</sub><sup>2</sup> = 1mA. (6) I<sub>C</sub> = 100 μA, V<sub>CE</sub> = 5V, f = 100Hz. (7) I<sub>C</sub> = 30 μA, V<sub>CE</sub> = 5V, f = 1kHz. (8) I<sub>C</sub> = 100 μA, V<sub>CE</sub> = 5V, f = 1kHz. (9) I<sub>C</sub> = 250 μA, V<sub>CE</sub> = 5V, f = 1kHz. (10) I<sub>C</sub> = 10 μA, V<sub>CE</sub> = 5V, f = 1kHz. (11) I<sub>C</sub> = 50mA, V<sub>CC</sub> = 30V, I<sub>B</sub><sup>1</sup> = I<sub>B</sub><sup>2</sup> = 5mA. (12) I<sub>C</sub> = 150mA, V<sub>CC</sub> = 30V, I<sub>B</sub><sup>1</sup> = I<sub>B</sub><sup>2</sup> = 15mA. (13) I<sub>C</sub> = 50mA, V<sub>CC</sub> = 10V, I<sub>B</sub><sup>1</sup> = I<sub>B</sub><sup>2</sup> = 5mA.

## GENERAL PURPOSE AMPS AND SWITCHES (Continued)

Type No.	Case Style	V <sub>CEO</sub> (V) Min	V <sub>CE0</sub> (V) Min	V <sub>EB0</sub> (V) Min	I <sub>CB0</sub> (mA) Max	V <sub>CB</sub> (V) @ I <sub>C</sub>	h <sub>FE</sub> @ I <sub>C</sub> & V <sub>CE</sub> Min Max (mA) (V)	V <sub>CE(SAT)</sub> & V <sub>BE(SAT)</sub> (V) Max Min	I <sub>C</sub> (mA) @ I <sub>C</sub> Max	C <sub>ob</sub> (pF) Max	f <sub>T</sub> (MHz) Min Max	I <sub>C</sub> (mA) @ I <sub>C</sub> Max	t <sub>off</sub> (ns) Max	NF (dB) Min	Test Condition	Process No.
MPS6533	TO-92 (72)	40	40	4	50	30	25 40 30	0.5 1.0	100	6						63
MPS6534	TO-92 (72)	40	40	4	50	30	50 90 60	0.3 1.0	100	6						63
MPS6535	TO-92 (72)	30	30	4	100	20	30	0.5 1.2	100	6						63
NS3905	TO-18	40	40	5			15 30 50 150 40 30	0.25 0.65 0.85 0.95	10 10 10 50	4.5	200	10	250	5	5/8	66
NS3906	TO-18	40	40	5			30 60 100 80 60	0.25 0.65 0.85 0.95	10 10 10 50	4.5	250	10	300	4	5/8	66
PN2906	TO-92 (72)	60	40	5	20	50	20 40 35 25 20	0.4 1.3 2.6	150 500	8	200	50	100		2	63
PN2906A	TO-92 (72)	60	60	5	10	50	40 40 40 40	0.4 1.3 2.6	150 500	8	200	50	100		2	63
PN2907	TO-92 (72)	60	40	5	20	50	30 100 75 50 35	0.4 1.3 2.6	150 500	8	200	50	100		2	63
PN2907A	TO-92 (72)	60	60	5	20	50	50 100 100 75	0.4 1.3 2.6	150 500	8	200	50	100		2	63
PN3638	TO-92 (72)	25	25	4	35*	15	20 20 30	0.25 1.0 0.8	50 300 10 300	20	100	50	170		1	63





GENERAL PURPOSE AMPS AND SWITCHES (Continued)

Type No.	Case Style	V <sub>CB0</sub> (V) Min	V <sub>CE0</sub> (V) Min	V <sub>EB0</sub> (V) Min	I <sub>CB0</sub> (mA) Max	V <sub>CB</sub> (V) @ (V)	h <sub>FE</sub> Min	I <sub>C</sub> (mA) Max	V <sub>CE</sub> (V) Max	V <sub>BE(SAT)</sub> & (V)		I <sub>C</sub> (mA) Max	C <sub>ob</sub> (pF) Max	f <sub>T</sub> (MHz) Min	I <sub>C</sub> (mA) Max	t <sub>off</sub> (ns) Max	NF (dB) Min	Test Condition	Process No.
										Max	Min								
PN3638A	TO-92 (72)	25	25	4	25*	15	20	300	2	0.25	1.1	50	10	150	50	170		1	63
PN3644	TO-92 (72)	45	45	5	35*	30	100	300	2	0.25	1.0	50	8	200	20	100		4	63
PN3645	TO-92 (72)	60	60	5	35*	50	100	300	2	0.25	1.0	50	8	200	20	100		4	63
PN4121	TO-92 (72)	40	40	5	25*	30	15	50	1	0.13	0.75	1	4.5	400	10	150	4	11/8	66
PN4122	TO-92 (72)	40	40	5	25*	30	30	50	1	0.13	0.75	1	4.5	450	10	150	4	11/8	66
PN4142	TO-92	60	40	5			20	500	10	0.4	1.3	150	8	200	50	100		12	63
PN4143	TO-92 (72)	60	40	5			30	500	10	0.4	1.3	150	8	200	50	100		12	63

TEST CONDITIONS:

(1) I<sub>C</sub> = 300mA, V<sub>CC</sub> = 10V, I<sub>B</sub><sup>1</sup> = I<sub>B</sub><sup>2</sup> = 30mA, (2) I<sub>C</sub> = 150mA, V<sub>CC</sub> = 6V, I<sub>B</sub><sup>1</sup> = I<sub>B</sub><sup>2</sup> = 15mA, (3) I<sub>C</sub> = 300mA, V<sub>CC</sub> = 15V, I<sub>B</sub><sup>1</sup> = I<sub>B</sub><sup>2</sup> = 30mA, (4) I<sub>C</sub> = 300mA, V<sub>CC</sub> = 30V, I<sub>B</sub><sup>1</sup> = I<sub>B</sub><sup>2</sup> = 30mA,  
 (5) I<sub>C</sub> = 10mA, V<sub>CC</sub> = 3V, I<sub>B</sub><sup>1</sup> = I<sub>B</sub><sup>2</sup> = 1mA, (6) I<sub>C</sub> = 100 μA, V<sub>CE</sub> = 5V, f = 100Hz, (7) I<sub>C</sub> = 30 μA, V<sub>CE</sub> = 5V, f = 1kHz, (8) I<sub>C</sub> = 100 μA, V<sub>CE</sub> = 5V, f = 1kHz, (9) I<sub>C</sub> = 250 μA, V<sub>CE</sub> = 5V,  
 f = 1kHz, (10) I<sub>C</sub> = 10 μA, V<sub>CE</sub> = 5V, f = 1kHz, (11) I<sub>C</sub> = 50mA, V<sub>CC</sub> = 30V, I<sub>B</sub><sup>1</sup> = I<sub>B</sub><sup>2</sup> = 5mA, (12) I<sub>C</sub> = 150mA, V<sub>CC</sub> = 30V, I<sub>B</sub><sup>1</sup> = I<sub>B</sub><sup>2</sup> = 15mA, (13) I<sub>C</sub> = 50mA, V<sub>CC</sub> = 10V, I<sub>B</sub><sup>1</sup> = I<sub>B</sub><sup>2</sup> = 5mA.



## GENERAL PURPOSE AMPS AND SWITCHES (Continued)

Type No.	Case Style	V <sub>CB0</sub> (V)		V <sub>CE0</sub> (V)		V <sub>EB0</sub> (V)		I <sub>CB0</sub> (mA) @ V <sub>CB</sub> (V)		h <sub>FE</sub> @ I <sub>C</sub> & V <sub>CE</sub> (V)		V <sub>CE(SAT)</sub> (V) & V <sub>BE(SAT)</sub> (V) @ I <sub>C</sub> (mA)		C <sub>ob</sub> (pF)		f <sub>T</sub> (MHz) @ I <sub>C</sub> (mA)		t <sub>off</sub> (ns)		NF (dB) Min	Test Condition	Process No.
		Min	Max	Min	Max	Min	Max	Min	Max	Min	Max	Min	Max	Min	Max	Min	Max	Min	Max			
PN4916	TO-92 (72)	30	30	5	15	25*	15	15	200	50	1	0.13	0.75	1	4.5	150	10	4	13/8	66		
								70	10	1	0.14	0.7	0.9	10								
								60	1	1	0.3	0.75	1.1	50								
PN4917	TO-92 (72)	30	30	5	15	25*	15	30	50	1	0.13	0.75	1	4.5	150	10	4	13/8	66			
								150	300	10	1	0.14	0.7							0.9	10	
								150	1	1	0.3	0.75	1.1							50		
PN5138	TO-92 (72)	30	30	5	20	50	20	50	10	10	10	0.3	1.0	10	7	30	0.5	66				
								50	1	10												
								50	800	0.1	10											
PN5139	TO-92 (72)	20	20	5	15	50*	15	15	50	10	10	0.2	0.7	1.0	5	200	10	13	66			
								40	1	1												
								40	1	10												
PN5142	TO-92 (72)	20	20	4	12	50*	12	15	300	10	10	0.5	0.75	1.25	10	200	50	1	63			
								30	50	1	0.2	0.8	2.5	300								
								30	50	1	0.2	0.8	2.5	300								
PN5143	TO-92 (72)	20	20	4	12	50*	12	15	300	10	10	0.5	1.5	50	10	200	50	1	63			
								30	50	1	0.2	0.8	2.5	300								
								30	50	1	0.2	0.8	2.5	300								
TN2905	TO-92+ (91)	60	40	5	50	20	50	30	500	10	10	0.4	1.3	150	8	100	50	2	63			
								100	300	150	10	1.6	2.6	500								
								75	10	10	10	1.6	2.6	500								
TN2905A	TO-92+ (91)	60	60	5	50	10	50	50	500	10	10	0.4	1.3	150	8	100	50	2	63			
								100	300	150	10	1.6	2.6	500								
								100	10	10	10	1.6	2.6	500								

### TEST CONDITIONS:

(1) I<sub>C</sub> = 300mA, V<sub>CC</sub> = 10V, I<sub>B</sub><sup>1</sup> = I<sub>B</sub><sup>2</sup> = 30mA. (2) I<sub>C</sub> = 150mA, V<sub>CC</sub> = 6V, I<sub>B</sub><sup>1</sup> = I<sub>B</sub><sup>2</sup> = 15mA. (3) I<sub>C</sub> = 300mA, V<sub>CC</sub> = 15V, I<sub>B</sub><sup>1</sup> = I<sub>B</sub><sup>2</sup> = 30mA. (4) I<sub>C</sub> = 300mA, V<sub>CC</sub> = 30V, I<sub>B</sub><sup>1</sup> = I<sub>B</sub><sup>2</sup> = 30mA. (5) I<sub>C</sub> = 10mA, V<sub>CC</sub> = 3V, I<sub>B</sub><sup>1</sup> = I<sub>B</sub><sup>2</sup> = 1mA. (6) I<sub>C</sub> = 100 μA, V<sub>CE</sub> = 5V, f = 100Hz. (7) I<sub>C</sub> = 30 μA, V<sub>CE</sub> = 5V, f = 1kHz. (8) I<sub>C</sub> = 100 μA, V<sub>CE</sub> = 5V, f = 1kHz. (9) I<sub>C</sub> = 250 μA, V<sub>CE</sub> = 5V, f = 1kHz. (10) I<sub>C</sub> = 10 μA, V<sub>CE</sub> = 5V, f = 1kHz. (11) I<sub>C</sub> = 50mA, V<sub>CC</sub> = 30V, I<sub>B</sub><sup>1</sup> = I<sub>B</sub><sup>2</sup> = 5mA. (12) I<sub>C</sub> = 150mA, V<sub>CC</sub> = 30V, I<sub>B</sub><sup>1</sup> = I<sub>B</sub><sup>2</sup> = 15mA. (13) I<sub>C</sub> = 50mA, V<sub>CC</sub> = 10V, I<sub>B</sub><sup>1</sup> = I<sub>B</sub><sup>2</sup> = 5mA.

**MEDIUM POWER**

Type No.	Case Style	V <sub>CEO</sub> (V) Min	V <sub>CE0</sub> (V) Min	V <sub>EB0</sub> (V) Min	I <sub>CB0</sub> (mA) Max	V <sub>CB</sub> (V)	h <sub>FE</sub> @ I <sub>C</sub> & V <sub>CE</sub> Min Max (mA) (V)	V <sub>CE(SAT)</sub> (V) Max	V <sub>BE(SAT)</sub> (V) Min	I <sub>C</sub> (mA) Max	C <sub>ob</sub> (pF) Max	f <sub>T</sub> (MHz) Min Max	I <sub>C</sub> (mA) Max	t <sub>off</sub> (ns) Max	NF (dB) Max	Test Condition	Process No.
2N3634	TO-39	140	140	5	100	100	25 50 50 45 40	0.3 0.5	0.8 0.9	10 50	10	150	30	600	3	1/2	73
2N3634 J, JTX	TO-39	140	140	5	100	100	30 50 50 45 25	0.3 0.6	0.8 0.9	10 50	10	150	30	600	3	1/2	73
2N3635	TO-39	140	140	5	100	100	50 100 90 80	0.3 0.5	0.8 0.9	10 50	10	200	30	600	3	1/2	73
2N3635 J, JTX	TO-39	140	140	5	100	100	60 100 100 90 55	0.3 0.6	0.8 0.9	10 50	10	200	30	600	3	1/2	73
2N3636	TO-39	175	175	5	100	100	25 50 50 45 40	0.3 0.5	0.8 0.9	10 50	10	150	30	600	3	1/2	73
2N3636 J, JTX	TO-39	175	175	5	100	175	30 50 50 45 25	0.3 0.6	0.8 0.9	10 50	10	150	30	600	3	1/2	73
2N3637	TO-39	175	175	5	100	100	50 100 100 90 80	0.3 0.5	0.8 0.9	10 50	10	200	30	600	3	1/2	73
2N3637 J, JTX	TO-39	175	175	5	100	175	60 100 100 90 55	0.3 0.6	0.8 0.9	10 50	10	200	30	600	3	1/2	73

**TEST CONDITIONS:**

(1) I<sub>C</sub> = 50mA, V<sub>CC</sub> = 100V, I<sub>B</sub><sup>1</sup> = I<sub>B</sub><sup>2</sup> = 5mA. (2) I<sub>C</sub> = 500μA, V<sub>CE</sub> = 10V, f = 1kHz. (3) I<sub>C</sub> = 500mA, V<sub>CE</sub> = 30V, I<sub>B</sub><sup>1</sup> = I<sub>B</sub><sup>2</sup> = 50mA. (4) I<sub>C</sub> = 150mA, V<sub>CC</sub> = 30V, I<sub>B</sub><sup>1</sup> = I<sub>B</sub><sup>2</sup> = 15mA. (5) I<sub>C</sub> = 100μA, V<sub>CC</sub> = 10V, f = 1kHz.

# PNP Transistors



## MEDIUM POWER (Continued)

Type No.	Case Style	V <sub>CB0</sub> (V) Min	V <sub>CE0</sub> (V) Min	V <sub>EB0</sub> (V) Min	I <sub>CB0</sub> (mA) Max	V <sub>CB</sub> (V) @ I <sub>C</sub>	h <sub>FE</sub> Min	I <sub>C</sub> (mA) @ V <sub>CE</sub>	V <sub>CE(SAT)</sub> (V) Max	V <sub>BE(SAT)</sub> (V) Min	I <sub>C</sub> (mA) @ V <sub>BE(SAT)</sub>	C <sub>ob</sub> (pF) Max	f <sub>T</sub> (MHz) Min	f <sub>T</sub> (MHz) Max	t <sub>off</sub> (ns) Max	NF (dB) Max	Test Condition	Process No.	
2N4030	TO-39	60	60	5	50	50	15	1A 5	1.0	1A	500	20	100	400	400		3	67	
2N4031	TO-39	80	80	5	50	60	25	1A 5	0.5	500	500	20	100	400	400		3	67	
2N4032	TO-39	60	60	5	50	50	40	1A 5	1	1A	500	20	150	500	400		3	67	
2N4033	TO-39	80	80	5	50	60	70	500 5	0.5	500	500	20	150	500	400		3	67	
2N4036	TO-39	90	65	7	20	60	100	300 5	0.15	150	150	30	60	500	700		4	67	
2N4037	TO-39	60	40	7	250	60	20	0.1 10	1.4	150	150	30	60	500	400		3	67	
2N4234	TO-39		40		100 μA	40	50	150 10	0.6	1.5	1A	100	3	100				67	
2N4235	TO-39		60		100 μA	60	20	500 1	0.6	1.5	1A	100	3	100				67	
2N4236	TO-39		80		100 μA	80	30	250 1	0.6	1.5	1A	100	3	100				67	
2N4314	TO-39	90	65		250	60	40	100 1	1.4	150	150	30	60	500	400			67	
2N4354	TO-92 (72)	Same as PN4354, see page 2-25 for explanation																	
2N4355	TO-92 (72)	Same as PN4355, see page 2-25 for explanation																	



**MEDIUM POWER (Continued)**

Type No.	Case Style	V <sub>CE0</sub> (V) Min	V <sub>CE0</sub> (V) Max	V <sub>EB0</sub> (V) Min	V <sub>EB0</sub> (V) Max	I <sub>CB0</sub> (mA) @ Max	V <sub>CB</sub> (V) Min	I <sub>FE</sub> @ (mA) Min	I <sub>CE</sub> & V <sub>CE</sub> (mA) (V) Max	V <sub>CE(SAT)</sub> & V <sub>BE(SAT)</sub> (V) (V) Max	I <sub>C</sub> @ (mA) Min	C <sub>ob</sub> (pF) Max	f <sub>T</sub> (MHz)		t <sub>off</sub> (ns) Max	NF (dB) Max	Test Condition	Process No.
													Min	Max				
2N4356	TO-92 (72)	60	60	5	100	40	25	500	1	1.0	1A	18	75	250	100			67
2N6554	TO-202 (35)						60	250	1									78
2N6555	TO-202 (35)	80	80	5	100	60	60	300	1	0.5	250							78
2N6556	TO-202 (35)	100	100	5	100	80	25	500	1	1.0	1A	18	75	250	100			78
40319	TO-39						60	300	1	0.5	250							78
92PE77A	TO-92+ (90)		40		250	15	35	200	4	1.4	150							67
92PE77B	TO-92+ (90)		45		100	60	25	500	2	0.5	500	30	50	200	200			78
92PE77C	TO-92+ (90)		60		100	80	40	250	2	1.0	1A	30	50	200	200			78
92PU51	TO-92+ (91)		80		100	100	25	500	2	0.5	500	30	50	200	200			78
92PU51A	TO-92+ (91)		30		100	40	40	250	2	1.0	1A	30	50	50	50			77
92PU55	TO-92+ (91)		40		100	50	50	10	1	0.5	1A	30	50	50	50			77
92PU56	TO-92+ (91)		60		100	40	20	500	1	0.35	250	30	50	200	200			79
92PU56	TO-92+ (91)		80		100	60	20	500	1	0.35	250	30	50	200	200			79

Same as PN4356, see page 2-25 for explanation

**TEST CONDITIONS:**

(1) I<sub>C</sub> = 50mA, V<sub>CC</sub> = 100V, I<sub>B</sub><sup>1</sup> = I<sub>B</sub><sup>2</sup> = 5mA. (2) I<sub>C</sub> = 500μA, V<sub>CE</sub> = 10V, f = 1kHz. (3) I<sub>C</sub> = 500mA, V<sub>CC</sub> = 30V, I<sub>B</sub><sup>1</sup> = I<sub>B</sub><sup>2</sup> = 50mA. (4) I<sub>C</sub> = 150mA, V<sub>CC</sub> = 30V, I<sub>B</sub><sup>1</sup> = I<sub>B</sub><sup>2</sup> = 15mA. (5) I<sub>C</sub> = 100μA, V<sub>CC</sub> = 10V, f = 1kHz.

# PNP Transistors



## MEDIUM POWER (Continued)

Type No.	Case Style	V <sub>CB0</sub> (V) Min	V <sub>CE0</sub> (V) Min	V <sub>EB0</sub> (V) Min	I <sub>CB0</sub> (mA) @ V <sub>CB</sub> (V) Max	h <sub>FE</sub> @ I <sub>C</sub> & V <sub>CE</sub> (V) Min Max	V <sub>CE(SAT)</sub> (V) & V <sub>BE(SAT)</sub> (V) @ I <sub>C</sub> (mA) Max Min Max	C <sub>ob</sub> (pF) Max	f <sub>T</sub> (MHz) Min Max	I <sub>C</sub> (mA) @ Max	t <sub>off</sub> (ns) Max	NF (dB) Max	Test Condition	Process No.
92PU57	TO-92+ (91)		100		100 80	20 500 1 50 250 1 80 50 1	0.35 250 200	30	50	200				79
92PU200	TO-92+ (91)	100	80		100 80	100 300 350 2 100 10 2	0.35 350 100	20	500	100				79
D41D1	TO-202 (35)		30		100* 45	10 150 1A 2 50 100 2	0.5 1.5 500							78
D41D2	TO-202 (35)		30		100* 45	20 300 1A 2 120 100 2	0.5 1.5 500							78
D41D4	TO-202 (35)		45		100* 60	10 150 1A 2 50 100 2	0.5 1.5 500							78
D41D5	TO-202 (35)		45		100* 60	20 360 1A 2 120 100 2	0.5 1.5 500							78
D41D7	TO-202 (35)		60		100* 75	10 150 1A 2 50 100 2	1.0 1.5 500							78
D41D8	TO-202 (35)		60		100* 75	20 360 1A 2 120 100 2	1.0 1.5 500							78
D41D10	TO-202 (35)		75		100* 90	10 150 1A 2 50 100 2	1.0 1.5 500							78
D41D11	TO-202 (35)		75		100* 90	20 360 1A 2 120 100 2	1.0 1.5 500							78
D41D13	TO-202 (35)		75		100* 90	50 150 100 2	1.0 1.5 500							78
D41D14	TO-202 (35)		75		100* 90	120 360 100 2	1.0 1.5 500							78
D41E1	TO-202 (35)		30		100* 40	10 100 2 50 100 2	1.0 1.3 1A							78
D41E5	TO-202 (35)		60		100* 70	10 100 2 50 100 2	1.0 1.3 1A							78
D41E7	TO-202 (35)		80		100* 90	10 100 2 50 100 2	1.0 1.3 1A							78
D43C1	TO-202 (36)		30		1 μA* 30	10 1A 1 25 200 1	0.5 1.3 1A 30	30						77
D43C2	TO-202 (36)		30		1 μA* 30	20 1A 1 40 120 200 1	0.5 1.3 1A 30	30						77
D43C3	TO-202 (36)		30		1 μA* 30	20 2A 1 40 200 1	0.5 1.3 1A 30	30						77
D43C4	TO-202 (36)		45		1 μA* 45	10 1A 1 25 200 1	0.5 1.3 1A 30	30						77



### MEDIUM POWER (Continued)

Type No.	Case Style	VCBO (V) Min	VCEO (V) Min	VEBO (V) Min	ICBO (mA) Max	VCB (V) Min	hFE Min	hFE Max	IC @ VCE & VCE (mA) & (V) 1A 1	VCE(SAT) (V) Max	VBE(SAT) (V) Min	IC @ VBE(SAT) (mA) Max	C <sub>ob</sub> (pF) Max	f <sub>T</sub> (MHz) Min	f <sub>T</sub> (MHz) Max	t <sub>off</sub> (ns) Max	NF (dB) Max	Test Condition	Process No.	
																				Max
D43C5	TO-202 (36)		45		1 μA*	45	20	40	1A 1 200 1	0.5	1.3	1A	30						77	
D43C6	TO-202 (36)		45		1 μA*	45	20	40	2A 1 200 1	0.5	1.3	1A	30						77	
D43C7	TO-202 (36)		60		1 μA*	60	10	25	1A 1 200 1	0.5	1.3	1A	30						78	
D43C8	TO-202 (36)		60		1 μA*	60	20	40	1A 1 200 1	0.5	1.3	1A	30						78	
D43C9	TO-202 (36)		60		1 μA*	60	20	40	2A 1 200 1	0.5	1.3	1A	30						78	
D43C10	TO-202 (36)		80		10 μA*	90	10	25	1A 1 200 1	0.5	1.3	1A	100						78	
D43C11	TO-202 (36)		80		10 μA*	90	20	40	1A 1 200 1	0.5	1.3	1A	100						78	
D43C12	TO-202 (36)		80		10 μA*	90	20	40	2A 1 200 1	0.5	1.3	1A	100						78	
MPSA55	TO-92 (72)		60	4	100	60	50	50	100 1 10 1	0.25		100		50					67	
MPSA56	TO-92 (72)		80	4	100	80	50	50	100 1 10 1	0.25		100		50					67	
MPS4354	TO-92 (72)	Same as PN4354, see page 2-25 for explanation																		
MPS4355	TO-92 (72)	Same as PN4355, see page 2-25 for explanation																		
MPS4356	TO-92 (72)	Same as PN4356, see page 2-25 for explanation																		
MPS6562	TO-92 (72)			5	100	20	50	200	500 1 100 1 35 10 1	0.5		500	30	60					67	
MPS6563	TO-92 (72)			5	100	20	50	200	350 1 100 1 35 10 1	0.5		350	30	60					60	
NSD202	TO-202 (35)		45	5	100	60	25	40	1A 5 500 5 150 10 5 40 10 5	0.2	0.9	100	30	60					77	

#### TEST CONDITIONS:

(1) I<sub>C</sub> = 50mA, V<sub>CC</sub> = 100V, I<sub>B</sub><sup>1</sup> = I<sub>B</sub><sup>2</sup> = 5mA. (2) I<sub>C</sub> = 500 μA, V<sub>CE</sub> = 10V, f = 1kHz. (3) I<sub>C</sub> = 500mA, V<sub>CC</sub> = 30V, I<sub>B</sub><sup>1</sup> = I<sub>B</sub><sup>2</sup> = 50mA. (4) I<sub>C</sub> = 150mA, V<sub>CC</sub> = 30V, I<sub>B</sub><sup>1</sup> = I<sub>B</sub><sup>2</sup> = 15mA. (5) I<sub>C</sub> = 100 μA, V<sub>CC</sub> = 10V, f = 1kHz.

# PNP Transistors

## MEDIUM POWER (Continued)

Type No.	Case Style	V <sub>CB0</sub> (V) Min	V <sub>CE0</sub> (V) Min	V <sub>EB0</sub> (V) Min	I <sub>CB0</sub> (mA) Max	V <sub>CB</sub> (V) @ I <sub>C</sub>	h <sub>FE</sub> @ I <sub>C</sub> & V <sub>CE</sub>		V <sub>CE(SAT)</sub> & V <sub>BE(SAT)</sub>		C <sub>ob</sub> (pF) Max	f <sub>T</sub> (MHz) @ I <sub>C</sub>		t <sub>off</sub> (ns) Max	NF (dB) Max	Test Condition	Process No.
							Min	Max	Max	Min		Max	Min				
NSD203	TO-202 (35)	60	45	5	100	60	30 50	1A 500	5 5	0.2	0.9	100	60	50			77
NSD204	TO-202 (35)	100	80	7	100	100	10 50	1A 100	5 5	0.2	0.9	100	60	50			79
NSD205	TO-202 (35)	100	80	7	100	100	10 20	1A 360	5 5	0.2	0.9	100	60	50			79
NSD206	TO-202 (35)	140	100	7	100	140	25 50	500 100	5 5	0.2	0.9	100	60	50			79
NSD6180	TO-202 (35)		75		500	80	10 40	1A 500	2 2	0.5	1.2	500	50	50			78
NSD6181	TO-202 (35)		50		500	60	10 30	1A 500	2 2	0.5	1.2	500	50	50			78
NSDU51	TO-202 (35)	40	30	5	100	30	50 60	1A 100	1 1	0.7	1A	1A	50	50			77
NSDU51A	TO-202 (35)	50	40	5	100	40	50 60	1A 100	1 1	0.7	1A	1A	50	50			77
NSDU52	TO-202 (35)	60	40	5	100	40	30 50	500 300	10 10	0.4	1.3	150	150	20			77
NSDU55	TO-202 (35)	60	60	4	100	60	20 50	500 250	1 1	0.35	250	250	50	200			78
NSDU56	TO-202 (35)	80	80	4	100	80	20 80	500 50	1 1	0.35	250	250	50	200			79
NSDU57	TO-202 (35)	100	100	4	100	100	20 50	500 250	1 1	0.35	250	250	50	200			79
NSE170	TO-202 (36)		40		100	60	12 30	1.5A 500	1 1	0.9	1.5	1.5A	50	100			77





**MEDIUM POWER (Continued)**

Type No.	Case Style	V <sub>CE0</sub> (V) Min	V <sub>CE0</sub> (V) Max	V <sub>BE0</sub> (V) Min	V <sub>BE0</sub> (V) Max	I <sub>CB0</sub> (mA) Max	V <sub>CB</sub> (V)	h <sub>FE</sub> @ I <sub>C</sub> & V <sub>CE</sub>		V <sub>CE(SAT)</sub> (V) Max	V <sub>BE(SAT)</sub> (V) Min		C <sub>ob</sub> (pF) Max	f <sub>T</sub> (MHz) Min		t <sub>off</sub> (ns) Max	NF (dB) Max	Test Condition	Process No.
								Min	Max		I <sub>C</sub> (mA)	V <sub>CE</sub> (V)		Min	Max				
NSE171	TO-202 (36)	60	100	80	100	100	80	12 30 50	1.5A 500 100	1 1	0.9	1.5 1.5A		50	100				78
PN4354	TO-92 (72)	60	50	50	50	50	50	30 40 50 40 25	500 100 10 1 0.1	10 10 10 10 10	0.15 0.5	0.9 1.1	30	100 500	50 50	400	3	3/5	67
PN4355	TO-92 (72)	60	50	50	50	50	50	75 75 100 75 60	500 100 10 1 0.1	10 10 10 10 10	0.15 0.5	0.9 1.1	30	100 500	50 50	400	3	3/5	67
PN4356	TO-92 (72)	80	50	50	50	50	50	30 40 50 40 25	500 100 10 1 0.1	10 10 10 10 10	0.15 0.5	0.9 1.1	30	100 500	50 50	400	3	3/5	67
TN4036	TO-92+ (91)	90	20	60	60	20	60	20 40 20	500 140 0.1	10 10 10	0.65	1.4	30	60	50	700		4	67
TN4037	TO-92+ (91)	60	250	60	60	250	60	50 15	2 1	10 10	1.4	150	30	60 100	50 50				67

**TEST CONDITIONS:**

(1) I<sub>C</sub> = 50mA, V<sub>CC</sub> = 100V, I<sub>B</sub><sup>1</sup> = I<sub>B</sub><sup>2</sup> = 5mA. (2) I<sub>C</sub> = 500 μA, V<sub>CE</sub> = 10V, f = 1kHz. (3) I<sub>C</sub> = 500mA, V<sub>CC</sub> = 30V, I<sub>B</sub><sup>1</sup> = I<sub>B</sub><sup>2</sup> = 50mA. (4) I<sub>C</sub> = 150mA, V<sub>CC</sub> = 30V, I<sub>B</sub><sup>1</sup> = I<sub>B</sub><sup>2</sup> = 15mA. (5) I<sub>C</sub> = 100 μA, V<sub>CC</sub> = 10V, f = 1kHz.

# PNP Transistors



POWER

Type No.	Case Style	VCBO (V) Min	VCEO (V) Min	VEBO (V) Min	ICES* ICET† @ (μA) Max	VCB (V)	hFE Min	hFE Max	IC @ (A)	VCE (V) Max	VBE(SAT) (V) Min	IC (A) Max	ft (MHz) Min	ft (MHz) Max	IC (A) Max	Process
2N4918	TO-126	40	40	40	100	40	10	100	1	1	1.3	1	3	0.25	0.25	3C
2N4919	TO-126	60	60	60	100	60	10	100	1	1	1.3	1	3	0.25	0.25	3C
2N4920	TO-126	80	80	80	100	80	10	100	1	1	1.3	1	3	0.25	0.25	3C
2N5193	TO-126	40	40	40	100	40	25	100	4	2	0.6	1.5	2	1	1	3E
2N5194	TO-126	60	60	60	100	60	10	100	4	2	0.6	1.5	2	1	1	3E
2N5195	TO-126	80	80	80	100	80	7	80	4	2	0.6	1.5	2	1	1	3E
2N6034	TO-126	40	40	40	500	40	100	15,000	4	3	2.0	2	25	0.75	0.75	3J
2N6035	TO-126	60	60	60	500	60	750	15,000	2	3	3.0	4.0	25	0.75	0.75	3J
2N6036	TO-126	80	80	80	500	80	100	15,000	4	3	2.0	2	25	0.75	0.75	3J
2N6106	TO-220 Lead Form + Clip	70	70	75	100†	75	5	150	6.5	4	1.0	2	10	0.5	0.5	5E
2N6107	TO-220	70	70	75	100†	75	5	150	2	4	1.0	2	10	0.5	0.5	5E
2N6108	TO-220 Lead Form + Clip	50	50	56	100†	56	5	150	6.5	4	1.0	2.5	10	0.5	0.5	5E
2N6109	TO-220	50	50	56	100†	56	5	150	6.5	4	1.0	2.5	10	0.5	0.5	5E
2N6110	TO-220 Lead Form + Clip	30	30	37.5	100†	37.5	5	150	3	4	1.0	3	10	0.5	0.5	5E



POWER (Continued)

Type No.	Case Style	V <sub>CB0</sub> (V) Min	V <sub>CEO</sub> (V) Min	V <sub>EB0</sub> (V) Min	I <sub>CEX1</sub> * ( $\mu$ A) @ V <sub>CB</sub> (V) Max	h <sub>FE</sub> Min Max @ I <sub>C</sub> & V <sub>CE</sub> (V)	V <sub>CE(SAT)</sub> (V) Max & V <sub>BE(SAT)</sub> (V) Min @ I <sub>C</sub> (A)	C <sub>ob</sub> (pF) Max	f <sub>T</sub> (MHz) Min Max	I <sub>C</sub> (A) @ Max	Process
2N6111	TO-220		30		100†	5 30 150 6.5 4	1.0 2.0 3 6.5	250	10	0.5	5E
2N6124	TO-220		45		100	10 25 100 4 2	0.6 1.4 1.5 4		2.5	1	5E
2N6125	TO-220		60		100	10 25 100 4 2	0.6 1.4 1.5 4		2.5	1	5E
2N6126	TO-220		80		100	7 20 80 4 2	0.6 1.4 1.5 4		2.5	1	5E
2N6132	TO-220		40		100	7 20 100 7 4	1.4 1.4 7		2.5	1	5E
2N6133	TO-220		60		100	7 20 100 7 4	1.4 1.4 7		2.5	1	5E
2N6134	TO-220		80		100	5 20 100 7 4	2.0 7		2.5	1	5E
2N6489	TO-220		40		500†	5 20 150 15 4	1.3 3.5 5		5	1	5A
2N6490	TO-220		60		500†	5 20 150 15 4	1.3 3.5 5		5	1	5A
2N6491	TO-220		80		500†	5 20 150 15 4	1.3 3.5 5		5	1	5A
D45C1	TO-220		30		10*	10 25 0.2 1	0.5 1.3 1	125	3	0.02	5F
D45C2	TO-220		30		10*	20 40 120 0.2 1	0.5 1.3 1	125	3	0.02	5F
D45C3	TO-220		30		10*	20 40 120 0.2 1	0.5 1.3 1	125	3	0.02	5E
D45C4	TO-220		45		10*	10 25 0.2 1	0.5 1.3 1	125	3	0.02	5F
D45C5	TO-220		45		10*	20 40 120 0.2 1	0.5 1.3 1	125	3	0.02	5F
D45C6	TO-220		45		10*	20 40 0.2 1	0.5 1.3 1	125	3	0.02	5E
D45C7	TO-220		60		10*	10 25 0.2 1	0.5 1.3 1	125	3	0.02	5F

# PNP Transistors



## POWER (Continued)

Type No.	Case Style	V <sub>CB0</sub> (V) Min	V <sub>CEO</sub> (V) Min	V <sub>EB0</sub> (V) Min	ICES* I <sub>CEXT</sub> (μA) Max	V <sub>CB</sub> (V)	hFE Min Max	I <sub>C</sub> (A) @ VCE (V)	V <sub>CE(SAT)</sub> (V) Max & V <sub>BE(SAT)</sub> (V) Min Max	I <sub>C</sub> (A) @ VCE (V)	C <sub>ob</sub> (pF) Max	f <sub>T</sub> (MHz) Min Max	I <sub>C</sub> (A)	Process
D45C8	TO-220		60		10*	70	20 40	1 0.2	0.5	1.3	125	3	0.02	5F
D45C9	TO-220		60		10*	70	20 40	2 0.2	0.5	1.3	125	3	0.02	5E
D45C10	TO-220		80		10*	90	10 25	1 0.2	0.5	1.3	125	3	0.02	5F
D45C11	TO-220		80		10*	90	20 40	1 0.2	0.5	1.3	125	3	0.02	5E
D45C12	TO-220		80		10*	90	20 40	2 0.2	0.5	1.3	125	3	0.02	5E
D45H1	TO-220		30		10	30	20 35	4 2	1.0	1.5				5A
D45H2	TO-220		30		10	30	40 60	4 2	1.0	1.5				5A
D45H4	TO-220		45		10	45	20 35	4 2	1.0	1.5				5A
D45H5	TO-220		45		10	45	40 60	4 2	1.0	1.5				5A
D45H7	TO-220		60		10	60	20 35	4 2	1.0	1.5				5A
D45H8	TO-220		60		10	60	40 60	4 2	1.0	1.5				5A
D45H10	TO-220		80		10	80	20 35	4 2	1.0	1.5				5A
D45H11	TO-220		80		10	80	40 60	4 2	1.0	1.5				5A
MJE170	TO-126		40		0.1	60	12 30 50	1.5 0.5 0.1	1.7 0.9 0.3	2.0 1.5 0.5	50	50	0.1	77
MJE171	TO-126		60		0.1	80	12 30 50	1.5 0.5 0.1	1.7 0.9 0.3	2.0 1.5 0.5	50	50	0.1	78
MJE172	TO-126		80		0.1	100	12 30 50	1.5 0.5 0.1	1.7 0.9 0.3	2.0 1.5 0.5	50	50	0.1	79
MJE370	TO-126		30		100	30	25	1						3C
MJE371	TO-126		40		100	40	40	1						3E
MJE700	TO-126		60		200	60	750	1.5	2.5	1.5		1	1.5	3J



POWER (Continued)

Type No.	Case Style	V <sub>CB0</sub> (V) Min	V <sub>CEO</sub> (V) Min	V <sub>EB0</sub> (V) Min	I <sub>CE</sub> <sup>*</sup> I <sub>CEXT</sub> <sup>†</sup> (μA) Max	V <sub>CB</sub> (V)	h <sub>FE</sub> Min	I <sub>C</sub> (A) Max	V <sub>CE</sub> (V)	V <sub>CE(SAT)</sub> (V) Max	V <sub>BE(SAT)</sub> (V) & Min	I <sub>C</sub> (A) Max	C <sub>ob</sub> (pF) Max	f <sub>T</sub> (MHz) Min	f <sub>T</sub> (MHz) Max	I <sub>C</sub> (A) Max	Process
MJE701	TO-126		60		200	60	750	2	3	2.8		2		1	1.5	1.5	3J
MJE702	TO-126		80		200	80	750		1.5	3		1.5		1	1.5	1.5	3J
MJE703	TO-126		80		200	80	750	2	3	2.8		2		1	1.5	1.5	3J
MJE710	TO-126		40		100 <sup>†</sup>	40	8	1	1	1.0	1.3	1.5					77
							20	0.5	1	0.4		0.5					
							40	0.15	1	0.15		0.15					
MJE711	TO-126		60		100 <sup>†</sup>	60	8	1	1	1.0	1.3	1.5					78
							20	0.5	1	0.4		0.5					
							40	0.15	1	0.15		0.15					
MJE712	TO-126		80		100 <sup>†</sup>	80	8	1	1	1.0	1.3	1.5					79
							20	0.5	1	0.4		0.5					
							40	0.15	1	0.15		0.15					
NSP42	TO-220		40		400 <sup>*</sup>	40	15	75	3	4		5		3	0.5	0.5	5E
NSP42A	TO-220		60		400 <sup>*</sup>	60	15	75	3	4		5		3	0.5	0.5	5E
NSP42B	TO-220		80		400 <sup>*</sup>	80	15	75	3	4		5		3	0.5	0.5	5E
NSP42C	TO-220		100		400 <sup>*</sup>	100	15	75	3	4		5		3	0.5	0.5	5E
NSP105	TO-220		50		100	50	25	100	2	2							5A
NSP370	TO-220		30		100	30	25		1	1							5F
NSP371	TO-220		40		100	40	40		1	1							5F
NSP576	TO-220	45	45		100	45	25	1	1	0.6		1		3	0.5	0.5	5F
NSP578	TO-220	60	60		100	60	25	1	1	0.6		1		3	0.5	0.5	5F
NSP580	TO-220	80	80		100	80	15	1	1	0.8		1		3	0.5	0.5	5F
NSP582	TO-220	100	100		100	100	15	1	1	0.8		1		3	0.5	0.5	5F
NSP586	TO-220	45	45		100	45	25	2	2	0.8		2		3	0.25	0.25	5E
							40	0.5	2	0.8		2					
NSP588	TO-220	60	60		100	60	20	2	2	0.8		2		3	0.25	0.25	5E
NSP590	TO-220	80	80		100	80	15	2	2	0.8		2		3	0.25	0.25	5E
NSP596	TO-220	45	45		100	45	25	3	2	1.0		3		3	0.25	0.25	5E
							40	1	2								
NSP598	TO-220	60	60		100	60	25	3	2	1.0		3		3	0.25	0.25	5E
							40	1	2								

# PNP Transistors



## POWER (Continued)

Type No.	Case Style	V <sub>CB0</sub> (V) Min	V <sub>CE0</sub> (V) Min	V <sub>EB0</sub> (V) Min	I <sub>CEX1</sub> <sup>†</sup> @ V <sub>CB</sub> (μA) Max	h <sub>FE</sub> Min	I <sub>C</sub> & V <sub>CE</sub> (A) (V) Max	V <sub>CE(SAT)</sub> (V) Max	V <sub>BE(SAT)</sub> (V) Min	I <sub>C</sub> (A) Max	C <sub>ob</sub> (pF) Max	f <sub>T</sub> (MHz) Min	f <sub>T</sub> (MHz) Max	IC (A) Max	Process
NSP600	TO-220	80	80		100	15	3	1.0		3		3		0.25	5E
NSP602	TO-220		100		100	15	3	1.0		3		3		0.25	5E
NSP692	TO-220		45		200	750	3	2.5		3		1		3	5J
NSP696A	TO-220		45		200	750	4	2.8		4		1		3	5J
NSP698	TO-220		60		200	750	3	2.5		3		1		3	5J
NSP698A	TO-220		60		200	750	4	2.8		4		1		3	5J
NSP700	TO-220		80		200	750	3	2.5		3		1		3	5J
NSP700A	TO-220		80		200	750	4	2.8		4		1		3	5J
NSP702	TO-220		100		200	750	3	2.5		3		1		3	5J
NSP2010	TO-220		40		400	15	3	1.5		5		3		0.5	5A
						25	1	1.0		3.5					
NSP2011	TO-220		60		400	15	3	1.5		5		3		0.5	5A
						25	1	1.0		3.5					
NSP2090	TO-220		60		200	750	3	2.5		3		1		3	5J
NSP2091	TO-220		60		200	750	4	2.5		4		1		3	5J
NSP2092	TO-220		80		200	750	3	2.5		3		1		3	5J
NSP2093	TO-220		80		200	750	4	2.5		4		1		3	5J
NSP2370	TO-220		40		200 <sup>†</sup>	10	1	0.7		1		3		0.5	5F
						40	0.2								
NSP2490	TO-220		40		200 <sup>†</sup>	8	3	1.2		3		3		0.5	5E
						20	1	0.6		1					
NSP2491	TO-220		60		200 <sup>†</sup>	8	3	1.2		3		3		0.5	5E
						20	1	0.6		1					
NSP2955	TO-220		60		100	5	10	8.0		10		2		0.5	5A
						20	4	1.1		4					
NSP3740	TO-220 Lead Bend + Clip		60		100	10	1	0.6		1		3		0.1	5F
						20	0.5								
						30	0.25								
						40	0.1								
NSP3741	TO-220 Lead Bend + Clip		80		100	10	1	0.6		1		3		0.100	5F
						20	0.5								
						30	0.25								
						40	0.1								



POWER (Continued)

Type No.	Case Style	V <sub>CE0</sub> (V) Min	V <sub>BE0</sub> (V) Min	I <sub>CEX1</sub> * @ V <sub>CB</sub> (μA) Max	h <sub>FE</sub> Min	I <sub>C</sub> & V <sub>CE</sub> (A) (V)	V <sub>CE(SAT)</sub> (V) Max	V <sub>BE(SAT)</sub> (V) Min	I <sub>C</sub> (A) Max	C <sub>ob</sub> (pF) Max	t <sub>T</sub> (MHz) Min	t <sub>T</sub> (MHz) Max	I <sub>C</sub> (A) Max	Process
NSP4918	TO-220	40		100	10	1 1 100 0.5 1 40 0.05 1	0.6	1.3	1		3		0.25	5F
NSP4919	TO-220	60		100	10	1 1 200 0.5 1 40 0.05 1	0.6	1.3	1		3		0.25	5F
NSP4920	TO-220	80		100	10	1 1 200 0.5 1 40 0.05 1	0.6	1.3	1		3		0.25	5F
NSP5193	TO-220	40		100	10	4 2 100 1.5 2 25 0.05 1	1.4		4		2		1	5E
NSP5194	TO-220	60		100	10	4 2 200 1.5 2 25 0.05 1	1.4		4		2		1	5E
NSP5195	TO-220	80		100	70	4 2 80 1.5 2 20 0.6 1	1.4		4		2		1	5E
NSP5974	TO-220	40		100†	7	5 2 20 2.5 2 40 0.5 2	1.7	2.5	5	300	2		0.5	5A
NSP5975	TO-220	60		100†	7	5 2 20 2.5 2 40 0.5 2	1.7	2.5	5	300	2		0.5	5A
NSP5976	TO-220	80		100†	7	5 2 20 2.5 2 40 0.5 2	1.7	2.5	5	300	2		0.5	5A
NSP5980	TO-220	40		100†	7	8 2 20 4 2 40 1 2	1.7	2.5	8	350	2		0.5	5A
NSP5981	TO-220	60		100†	7	8 2 20 4 2 40 1 2	1.7	2.5	8	350	2		0.5	5A
NSP5982	TO-220	80		100†	7	8 2 20 4 2 40 1 2	1.7	2.5	8	350	2		0.5	5A
TIP30	TO-220	40		200*	15	1 4 75 0.2 4 40 0.2 4	0.7		1		3		0.2	5F
TIP30A	TO-220	60		200*	15	1 4 75 0.2 4 40 0.2 4	0.7		1		3		0.2	5F
TIP30B	TO-220	80		200*	15	1 4 75 0.2 4 40 0.2 4	0.7		1		3		0.2	5F

# PNP Transistors



## POWER (Continued)

Type No.	Case Style	V <sub>CB0</sub> (V) Min	V <sub>CE0</sub> (V) Min	V <sub>EB0</sub> (V) Min	I <sub>CE0</sub> * I <sub>CEX1</sub> † @ (μA) (V) Max	h <sub>FE</sub> Min Max	I <sub>C</sub> @ (A) Max	V <sub>CE(SAT)</sub> (V) Max	V <sub>BE(SAT)</sub> (V) Min Max	I <sub>C</sub> @ (A) Max	C <sub>ob</sub> (pF) Max	f <sub>T</sub> (MHz) Min Max	I <sub>C</sub> (A) Max	Process
TIP30C	TO-220		100		200*	15 40	1 0.2	0.7		1		3	0.2	5F
TIP32	TO-220		40		200*	10 25	3 1	1.2		3		3	0.5	5F
TIP32A	TO-220		60		200*	10 25	3 1	1.2		3		3	0.5	5F
TIP32B	TO-220		80		200*	10 25	3 1	1.2		3		3	0.5	5F
TIP32C	TO-220		100		200*	10 25	3 1	1.2		3		3	0.5	5F
TIP42	TO-220		40		400*	15 30	3 0.3	1.5		6		3	0.5	5A
TIP42A	TO-220		60		400*	15 30	3 0.3	1.5		6		3	0.5	5A
TIP42B	TO-220		80		400*	15 30	3 0.3	1.5		6		3	0.5	5A
TIP42C	TO-220		100		400*	15 30	3 0.3	1.5		6		3	0.5	5A
TIP62	TO-220		40		200*	15 40	0.5 0.05	0.7		0.5		3	0.05	5F
TIP62A	TO-220		60		200*	15 40	0.5 0.05	0.7		0.5		3	0.05	5F
TIP62B	TO-220		80		200*	15 40	0.5 0.05	0.7		0.5		3	0.05	5F
TIP62C	TO-220		100		200*	15 40	0.5 0.05	0.7		0.5		3	0.05	5F
TIP115	TO-220		60		1 mA	500 1000	2 1	2.5		2				5J
TIP116	TO-220		80		1 mA	500 1000	2 1	2.5		2				5J
TIP117	TO-220		100		1 mA	500 1000	2 1	2.5		2				5J
TIP125	TO-220		60		200	1000	3	4.0		5				5K
TIP126	TO-220		80		200	1000	3	4.0		5				5K
TIP127	TO-220		100		200	1000	3	4.0		5				5K





**POWER (Continued)**

Type No.	Case Style	VCBO (V) Min	VCEO (V) Min	VEBO (V) Min	ICES* ICEX† @ (μA) Max	VCB (V)	hFE Min	hFE Max @ IC (A)	VCE & VCE (V)	VCE(SAT) (V) Max	VBE(SAT) (V) Min	VBE(SAT) (V) Max	IC @ (A) Min	IC @ (A) Max	C <sub>ob</sub> (pF) Max	f <sub>T</sub> (MHz) Min	f <sub>T</sub> (MHz) Max	IC (A)	Process
TIP135	TO-220		60		200	60	1000 500	15,000 4	4 4	3.0 2.0			6 4		200				5K
TIP136	TO-220		80		200	80	1000 500	15,000 4	4 4	3.0 2.0			6 4		200				5K
TIP137	TO-220		100		200	100	1000 500	15,000 4	4 4	3.0 2.0			6 4		200				5K



**DUAL DIFFERENTIAL AMPS**

Type No.	Case Style	VCBO (V) Min	VCEO (V) Min	VEBO (V) Min	ICBO @ (mA) Max	VCB (V)	HFE Min	HFE Max @ IC (mA)	HFE <sub>1</sub> HFE <sub>2</sub> (%) Max	VBE <sub>1</sub> -VBE <sub>2</sub> (mV) Max	ΔVBE <sub>1</sub> -VBE <sub>2</sub> ΔT (μV/°C) Max	C <sub>ob</sub> (pF) Max	f <sub>T</sub> (MHz) Min	f <sub>T</sub> (MHz) Max	NF (dB) Max	Test Condition	No. Process
2N3347	TO-78	60	45	6	10	45	60 40	1 300	10 0.01	5	10	6	60	240	4	1	62
2N3348	TO-78	60	45	6	10	45	60 40	1 300	20 0.01	10	20	6	60	240	4	1	62
2N3349	TO-78	60	45	6	10	45	60 40	1 300	40 0.01	20	40	6	60	240	4	1	62
2N3350	TO-78	60	45	6	10	45	150 100	1 300	10 0.01	5	10	6	60	240	4	1	62
2N3351	TO-78	60	45	6	10	45	150 100	1 300	20 0.01	10	20	6	60	240	4	1	62
2N3352	TO-78	60	45	6	10	45	150 100	1 300	40 0.01	20	40	6	60	240	4	1	62
2N3726	TO-78	45	45	5	10	30	115 135 120 80	50 350 1 0.1 0.01	10	5	20	8	200	600	4	2	62
2N3727	TO-78	45	45	5	10	30	135 120 80	50 350 1 0.1 0.01	10	2.5	10	8	200	600	4	2	62

**TEST CONDITIONS:**

(1) IC = 10 μA, VCE = 5V, f = 15.7kHz. (2) IC = 30 μA, VCE = 5V, f = 1kHz. (3) IC = 100 μA, VCE = 10V, f = 1kHz. (4) IC = 20 μA, VCE = 5V, f = 1kHz.



## DUAL DIFFERENTIAL AMPS (Continued)

Type No.	Case Style	V <sub>CB0</sub> (V) Min	V <sub>CE0</sub> (V) Min	V <sub>EB0</sub> (V) Min	I <sub>CB0</sub> (mA) @ Max	V <sub>CB</sub> (V)	HFE Min	I <sub>C</sub> (mA) @ Max	HFE <sup>1</sup> HFE <sup>2</sup> (%) Max	V <sub>BE1</sub> -V <sub>BE2</sub> (mV) Max	$\Delta V_{BE1}$ - $\Delta V_{BE2}$ $(\mu V/^\circ C)$ Max	C <sub>ob</sub> (pF) Max	f <sub>T</sub> (MHz) Min Max	NF (dB) Max	Test Condition	No. Process	
2N3800	TO-71	60	60	5	10	50	125	10				4	100	3	4	62	
							150	1	450								
							150	0.5	450								
2N3806	TO-78	60	60	5	10	50	125	10				4	100	3	3	62	
							150	1	450								
							150	0.5	450								
2N3807	TO-78	60	60	5	10	50	250	10				4	100	1.5	3	62	
							300	1	900								
							300	0.5	900								
2N3808	TO-78	60	60	5	10	50	225	0.01				4	100	3	3	62	
							125	10	450	20	5	20					
							150	1	450								
2N3809	TO-78	60	60	5	10	50	250	10				4	100	1.5	3	62	
							300	1	900								
							300	0.5	900								
2N3810	TO-78	60	60	5	10	50	125	10	10	3	10	4	100	3	3	62	
							150	1	450								
							150	0.5	450								
2N3810 J, JTX, JTXV	TO-78	60	60	5	10	50	125	10	10	5	10	5	100	3	3	62	
							150	1	450								
							150	0.5	450								



DUAL DIFFERENTIAL AMPS (Continued)

Type No.	Case Style	V <sub>CE0</sub> (V) Min	V <sub>EBO</sub> (V) Min	I <sub>CB0</sub> (nA) Max	V <sub>CB</sub> (V)	HFE Min	HFE Max @ I <sub>C</sub> (mA)	HFE <sup>1</sup> HFE <sup>2</sup> (%) Max	V <sub>BE</sub> <sup>1</sup> -V <sub>BE</sub> <sup>2</sup> (mV) Max	$\frac{\Delta V_{BE}^1}{\Delta T}$ $\frac{-V_{BE}^2}{\Delta T}$ ( $\mu$ V/ $^{\circ}$ C) Max	C <sub>ob</sub> (pF) Max	f <sub>T</sub> (MHz) Min Max	NF (dB) Max	Test Condition	No. Process
2N3810A	TO-78	60	5	10	50	125	10	5	1.5	5	4	100	500	3	62
						150	1								
						150	0.5								
						100	0.01								
2N3811	TO-78	60	5	10	50	250	10	10	3	10	4	100	500	1.5	62
						300	1								
						300	0.5								
						225	0.01								
2N3811 J, JTX, JTXV	TO-78	60	5	10	50	250	10	10	3	10	5	100	500	1.5	62
						300	1								
						300	0.5								
						225	0.01								
2N3811A	TO-78	60	5	10	50	250	10	5	1.5	5	4	100	500	1.5	62
						300	1								
						300	0.5								
						225	0.01								
2N4015	TO-78	60	5	10	50	115	50	10	5	20	8	200	600	4	62
						135	1								
						120	0.1								
						80	0.01								
2N4016	TO-78	60	5	10	50	115	50	10	2.5	10	8	200	600	4	62
						135	1								
						120	0.1								
						80	0.01								
2N4017	TO-78	80	6	10	70	90	50				6	40	160	3	62
						100	10								
						100	1								
						60	0.001								

TEST CONDITIONS:

(1) I<sub>C</sub> = 10  $\mu$ A, V<sub>CE</sub> = 5V, f = 15.7kHz. (2) I<sub>C</sub> = 30  $\mu$ A, V<sub>CE</sub> = 5V, f = 1kHz. (3) I<sub>C</sub> = 100  $\mu$ A, V<sub>CE</sub> = 10V, f = 1kHz. (4) I<sub>C</sub> = 20  $\mu$ A, V<sub>CE</sub> = 5V, f = 1kHz.



## DUAL DIFFERENTIAL AMPS (Continued)

Type No.	Case Style	V <sub>CB0</sub> (V) Min	V <sub>CE0</sub> (V) Min	V <sub>EB0</sub> (V) Min	I <sub>CB0</sub> (mA) Max	V <sub>CB</sub> (V)	HFE Min	HFE Max	I <sub>C</sub> (mA) @	HFE <sub>1</sub> HFE <sub>2</sub> (%) Max	V <sub>BE1</sub> -V <sub>BE2</sub> (mV) Max	ΔV <sub>BE1</sub> -V <sub>BE2</sub> ΔI (μV/°C) Max	C <sub>ob</sub> (pF) Max	f <sub>T</sub> (MHz) Min	f <sub>T</sub> (MHz) Max	NF (dB) Max	Test Condition	No. Process
2N4018	TO-78	60	60	6	10	50	90	50	50	20	5	20	6	40	160	3	4	62
							100	10	10									
							100	600	1									
							100	0.1	100									
2N4019	TO-78	45	45	6	10	30	180	50	50	20	5	20	6	50	160	2	4	62
							200	10	10									
							250	600	1									
							250	0.1	250									
2N4020	TO-78	45	45	6	10	30	180	50	50	20	5	20	6	50	160	2	4	62
							200	10	10									
							250	600	1									
							250	0.1	250									
2N4021	TO-78	60	60	6	10	50	90	50	50	20	5	20	6	40	160	3	4	62
							100	10	10									
							100	500	1									
							100	0.1	100									
2N4023	TO-78	45	45	6	10	30	180	50	50	10	3	10	6	50	160	2	4	62
							200	10	10									
							250	600	1									
							250	0.1	250									
2N4024	TO-78	60	60	6	10	50	90	50	50	10	3	10	6	40	160	3	4	62
							100	10	10									
							100	500	1									
							100	0.1	100									
2N4025	TO-78	60	60	6	10	50	180	50	50	10	3	10	6	50	160	2	4	62
							200	10	10									
							250	600	1									
							250	0.1	250									

### TEST CONDITIONS:

(1) I<sub>C</sub> = 10 μA, V<sub>CE</sub> = 5V, f = 15.7kHz. (2) I<sub>C</sub> = 30 μA, V<sub>CE</sub> = 5V, f = 1kHz. (3) I<sub>C</sub> = 100 μA, V<sub>CE</sub> = 10V, f = 1kHz. (4) I<sub>C</sub> = 20 μA, V<sub>CE</sub> = 5V, f = 1kHz.



Section 3

**Pro Electron Series**



# Pro Electron Series



Type No.	Case Style	V <sub>CE</sub> *		V <sub>CE0</sub> (V) Min	V <sub>EB0</sub> (V) Min	I <sub>CB0</sub> * (mA) Max	V <sub>CB</sub> (V)	h <sub>FE</sub>		I <sub>C</sub> & V <sub>CE</sub> (V) @ (mA)	V <sub>CE(SAT)</sub> (V) Max		V <sub>BE(SAT)</sub> & V <sub>BE(ON)*</sub> (V) Min Max		C <sub>ob</sub> (pF) Max	f <sub>T</sub> (MHz) Min Max		I <sub>C</sub> (mA) @ (mA) Max	t <sub>off</sub> (ns) Max	NF (dB) Max	Test Condition	Process No.
		Min	Max					Min	Max		Min	Max	Min	Max		Min	Max					
BC107	TO-18	50	45	6	15*	50	40 125 40	0.01 500* 0.01	5 5 5	0.6 0.2	0.55 0.7*	100 10	150	10	4.5	150	10	10	1	04		
BC107A	TO-18	50	45	6	15*	50	125	260* 2	5	0.6 0.2	0.55 0.7*	100 10	150	10	4.5	150	10	10	1	04		
BC107B	TO-18	50	45	6	15*	50	40 240	0.01 500* 2	5 5	0.6 0.2	0.55 0.7*	100 10	150	10	4.5	150	10	10	1	04		
BC106	TO-18	30	20	5	15*	30	40 125	0.01 900* 2	5 5	0.6 0.2	0.55 0.7*	100 10	150	10	4.5	150	10	10	1	04		
BC108A	TO-18	30	20	5	15*	30	40 125	0.01 260* 2	5 5	0.6 0.2	0.55 0.7*	100 10	150	10	4.5	150	10	10	1	04		
BC108B	TO-18	30	20	5	15*	30	40 240	0.01 500* 2	5 5	0.6 0.2	0.55 0.7*	100 10	150	10	4.5	150	10	10	1	04		
BC108C	TO-18	30	20	5	15*	30	40 450	0.01 900* 2	5 5	0.6 0.2	0.55 0.7*	100 10	150	10	4.5	150	10	10	1	04		
BC109	TO-18	30	20	5	15*	30	100 240	0.01 900* 2	5 5	0.6 0.2	0.55 0.7*	100 10	150	4	4.5	150	10	4	1	04		
BC109B	TO-18	30	20	5	15*	30	100 240	0.01 500* 2	5 5	0.6 0.2	0.55 0.7*	100 10	150	4	4.5	150	10	4	1	04		
BC109C	TO-18	30	20	5	15*	30	100 450	0.01 900* 2	5 5	0.6 0.2	0.55 0.7*	100 10	150	4	4.5	150	10	4	1	04		
BC140	TO-39	80*	40	7	100*	60	40	250	100	1	1.0	1.8*	1A	25	50	850	50	50	2	14		
BC140-6	TO-39	80*	40	7	100*	60	40	100	100	1	1.0	1.8*	1A	25	50	850	50	50	2	14		
BC140-10	TO-39	80*	40	7	100*	60	63	160	100	1	1.0	1.8*	1A	25	50	850	50	50	2	14		
BC140-16	TO-39	80*	40	7	100*	60	100	250	100	1	1.0	1.8*	1A	25	50	850	50	50	2	14		
BC141	TO-39	100*	60	7	100*	60	40	250	100	1	1.0	1.8*	1A	25	50	850	50	50	2	14		
BC141-6	TO-39	100*	60	7	100*	60	40	100	100	1	1.0	1.8*	1A	25	50	850	50	50	2	14		
BC141-10	TO-39	100*	60	7	100*	60	63	160	100	1	1.0	1.8*	1A	25	50	850	50	50	2	14		
BC143	TO-5	60	60	5	50	40	20	200	2	1.5	1.5	500	200	2	60	50	50	2	63			



Type No.	Case Style	V <sub>CE0</sub> (V) Min	V <sub>BE0</sub> (V) Min	I <sub>CB0</sub> (nA) Max	V <sub>CB</sub> (V)	H <sub>FE</sub> h <sub>FE</sub> 1 kHz*	I <sub>C</sub> & V <sub>CE</sub> (mA) & (V)	V <sub>CE(SAT)</sub> (V) Max	V <sub>BE(SAT)</sub> & V <sub>BE(ON)</sub> * (V) Min Max	I <sub>C</sub> (mA) Max	C <sub>ob</sub> (pF) Max	f <sub>T</sub> (MHz) Min Max	t <sub>off</sub> (ns) Max	NF (dB) Max	Test Condition	Process No.
BC146-1	TO-92 (74)	20	4	50	40	100 80	2 1 200 0.2 0.2	1.5	1.5 500 200	20	20	60	50		2	04
BC146-2	TO-92 (74)	20	4	50	40	140 140	2 1 350 0.2 0.2	1.5	1.5 500 200	20	20	60	50		2	04
BC146-3	TO-92 (74)	20	4	50	40	280 280	2 1 550 0.2 0.2	1.5	1.5 500 200	20	20	60	50		2	04
BC160	TO-39	40*	40	100	40	40	250 100 1	1.0	1.7* 1A	30	30	50	50	650	2	67
BC160-6	TO-39	40*	40	100	40	40	100 100 1	1.0	1.7* 1A	30	30	50	50	650	2	67
BC160-10	TO-39	40*	40	100	40	63	160 100 1	1.0	1.7* 1A	30	30	50	50	650	2	67
BC160-16	TO-39	40*	40	100	40	100	250 100 1	1.0	1.7* 1A	30	30	50	50	650	2	67
BC161	TO-39	60*	60	100	60	40	250 100 1	1.0	1.7* 1A	30	30	50	50	650	2	67
BC161-6	TO-39	60*	60	100	60	40	100 100 1	1.0	1.7* 1A	30	30	50	50	650	2	67
BC161-10	TO-39	60*	60	100	60	63	160 100 1	1.0	1.7* 1A	30	30	50	50	650	2	67
BC161-16	TO-39	60*	60	100	60	100	250 100 1	1.0	1.7* 1A	30	30	50	50	650	2	67
BC167	TO-92 (74)	60*	45	15*	50	110 125	2 5 500* 2 5	0.2 0.6	1.0 1.7* 1A 0.55 0.7* 2	10 4.5	4.5	150	10	10	1	04
BC167A	TO-92 (74)	60*	45	15*	50	110 125	2 5 500* 2 5	0.2 0.6	1.0 1.7* 1A 0.55 0.7* 2	10 4.5	4.5	150	10	10	1	04
BC167B	TO-92 (74)	60*	45	15*	50	110 240	2 5 500* 2 5	0.2 0.6	1.0 1.7* 1A 0.55 0.7* 2	10 4.5	4.5	150	10	10	1	04
BC168	TO-92 (74)	20	5	15*	30	110 125	2 5 900* 2 5	0.2 0.6	1.0 1.7* 1A 0.55 0.70* 2	10 4.5	4.5	150	10	10	1	04
BC168A	TO-92 (74)	20	5	15*	30	110 125	2 5 260* 2 5	0.2 0.6	1.0 1.7* 1A 0.55 0.70* 2	10 4.5	4.5	150	10	10	1	04
BC168B	TO-92 (74)	20	5	15*	30	110 240	2 5 500* 2 5	0.2 0.6	1.0 1.7* 1A 0.55 0.70* 2	10 4.5	4.5	150	10	10	1	04

**TEST CONDITIONS:**

(1) I<sub>C</sub> = 200 μA, V<sub>CE</sub> = 5V, f = 1kHz. (2) I<sub>C</sub> = 100mA, V<sub>CE</sub> = 20V, I<sub>B</sub><sup>1</sup> = I<sub>B</sub><sup>2</sup> = 5mA. (3) I<sub>C</sub> = 200 μA, V<sub>CE</sub> = 2V, f = 1kHz. (4) I<sub>C</sub> = 100mA, V<sub>CE</sub> = 10V, I<sub>B</sub><sup>1</sup> = I<sub>B</sub><sup>2</sup> = 10mA. (5) I<sub>C</sub> = 10mA, V<sub>CE</sub> = 3V, I<sub>B</sub><sup>1</sup> = I<sub>B</sub><sup>2</sup> = 1mA. (6) I<sub>C</sub> = 100 μA, V<sub>CE</sub> = 5V, f = 1kHz. (7) I<sub>C</sub> = 1mA, V<sub>CE</sub> = 10V, f = 200kHz. (8) I<sub>C</sub> = 1mA, V<sub>CE</sub> = 5V, f = 1kHz. (9) I<sub>C</sub> = 150mA, V<sub>CE</sub> = 6V, I<sub>B</sub><sup>1</sup> = I<sub>B</sub><sup>2</sup> = 15mA. (10) I<sub>C</sub> = 200 μA, V<sub>CE</sub> = 5V, f = 1kHz. (11) I<sub>C</sub> = 150mA, V<sub>CE</sub> = 10V, I<sub>B</sub><sup>1</sup> = I<sub>B</sub><sup>2</sup> = 75mA. (12) I<sub>C</sub> = 300mA, V<sub>CE</sub> = 25V, I<sub>B</sub><sup>1</sup> = I<sub>B</sub><sup>2</sup> = 30mA. (13) I<sub>C</sub> = 10 μA, V<sub>CE</sub> = 5V, f = WB. (14) I<sub>C</sub> = 500mA, V<sub>CE</sub> = 25V, I<sub>B</sub><sup>1</sup> = 50mA, I<sub>B</sub><sup>2</sup> = 25mA. (15) I<sub>C</sub> = 10mA, V<sub>BE</sub> = 2V, I<sub>B</sub><sup>1</sup> = 3mA, I<sub>B</sub><sup>2</sup> = 1mA. (16) I<sub>C</sub> = 100mA, I<sub>B</sub><sup>1</sup> = 40mA, I<sub>B</sub><sup>2</sup> = 20mA.



Type No.	Case Style	V <sub>CE</sub> * V <sub>CB</sub> (V) Min	V <sub>CEO</sub> (V) Min	V <sub>EB</sub> (V) Min	I <sub>CE</sub> * I <sub>CB</sub> (mA) Max	V <sub>CB</sub> (V) Min	V <sub>CE</sub> (V) Min	h <sub>FE</sub> 1 kHz* Min	I <sub>C</sub> & V <sub>CE</sub> (mA) (V) Max	V <sub>CE(SAT)</sub> (V) Max	V <sub>BE(SAT)</sub> & V <sub>BE(ON)*</sub> (V) Min	I <sub>C</sub> (mA) Min	I <sub>C</sub> (mA) Max	C <sub>ob</sub> (pF) Max	f <sub>T</sub> (MHz) Min	f <sub>T</sub> (MHz) Max	t <sub>off</sub> (ns) Max	NF (dB) Max	Test Condition	Process No.
BC168C	TO-92 (74)		20	5	15*	30	110 450	2 900*	2 2	0.2 0.6	0.55	10 100	100 2	4.5	150	10		10	1	04
BC169	TO-92 (74)		20	5	15*	30	110 240	2 900*	2 2	0.2 0.6	0.55	10 100	100 2	4.5	150	10		4	1	04
BC169B	TO-92 (74)		20	5	15*	30	110 240	2 500*	2 2	0.2 0.6	0.55	10 100	100 2	4.5	150	10		4	1	04
BC169C	TO-92 (74)		20	5	15*	30	110 450	2 900*	2 2	0.2 0.6	0.55	10 100	100 2	4.5	150	10		4	1	04
BC177	TO-18	50	45	5	100	20	110 125	2 500*	2 2	0.18	0.78 0.75*	10 2	100 2	4.5	150	10		10	1	71
BC177A	TO-18	50	45	5	100	20	110 125	2 260*	2 2	0.18	0.78 0.75*	10 2	100 2	4.5	150	10		10	1	71
BC177B	TO-18	50	45	5	100	20	110 240	2 500*	2 2	0.18	0.78 0.75*	10 2	100 2	4.5	150	10		10	1	71
BC177VI	TO-18	50	45	5	100	20	110 75	2 150*	2 2	0.18	0.78 0.75*	10 2	100 2	4.5	150	10		10	1	71
BC178	TO-18	30	25	5	100	20	110 125	2 900*	2 2	0.18	0.78 0.75*	10 2	100 2	4.5	150	10		10	1	71
BC178A	TO-18	30	25	5	100	20	110 125	2 260*	2 2	0.18	0.78 0.75*	10 2	100 2	4.5	150	10		10	1	71
BC178B	TO-18	30	25	5	100	20	110 240	2 500*	2 2	0.18	0.78 0.75*	10 2	100 2	4.5	150	10		10	1	71
BC179	TO-18	25	20	5	100	20	110 125	2 900*	2 2	0.18	0.78 0.75*	10 2	100 2	4.5	150	10		4	1	71
BC179A	TO-18	25	20	5	100	20	110 125	2 260*	2 2	0.18	0.78 0.75*	10 2	100 2	4.5	150	10		4	1	71





Type No.	Case Style	V <sub>CE(S)</sub> V <sub>CE0</sub> (V) Mfn	V <sub>CE0</sub> (V) Mfn	V <sub>BE0</sub> (V) Mfn	I <sub>CE(S)</sub> I <sub>CE0</sub> @ V <sub>CE</sub> (mA) Max	HFE h <sub>FE</sub> 1 kHz* Min Max	I <sub>C</sub> & V <sub>CE</sub> (mA) (V) Max	V <sub>CE(SAT)</sub> (V) Max	V <sub>BE(SAT)</sub> & V <sub>BE(ON)*</sub> (V) Min Max	I <sub>C</sub> (mA) Max	C <sub>ob</sub> (pF) Max	f <sub>T</sub> (MHz) Min Max	I <sub>C</sub> (mA) Max	t <sub>off</sub> (ns) Max	NF (dB) Max	Test Condition	Process No.
BC179B	TO-18	25	20	5	100	20	2	0.18	0.78 0.75* 1.0*	10	4.5	150	10		4	1	71
BC182	TO-92 (77)	60	50	5	15	40	0.01	0.6	1.2	100	5	150	10		10	1	04
BC182A	TO-92 (77)	60	50	5	15	40	0.01	0.6	0.55	100	5	150	10		10	1	04
BC182B	TO-92 (77)	60	50	5	15	40	0.01	0.6	0.55	100	5	150	10		10	1	04
BC182L	TO-92 (74)	60	50	5	15	40	0.01	0.6	0.55	100	5	150	10		10	1	04
BC182LA	TO-92 (74)	60	50	5	15	40	0.01	0.6	0.55	100	5	150	10		10	1	04
BC182LB	TO-92 (74)	60	50	5	15	40	0.01	0.6	0.55	100	5	150	10		10	1	04
BC183	TO-92 (77)	45	30	5	15	40	0.01	0.6	0.55	100	5	150	10		10	1	04
BC183A	TO-92 (77)	45	30	5	15	40	0.01	0.6	0.55	100	5	150	10		10	1	04
BC183B	TO-92 (77)	45	30	5	15	40	0.01	0.6	0.55	100	5	150	10		10	1	04
BC183C	TO-92 (77)	45	30	5	15	40	0.01	0.6	0.55	100	5	150	10		10	1	04

**TEST CONDITIONS:**

(1) I<sub>C</sub> = 200 μA, V<sub>CE</sub> = 5V, f = 1kHz. (2) I<sub>C</sub> = 100mA, V<sub>CE</sub> = 20V, I<sub>B</sub><sup>1</sup> = I<sub>B</sub><sup>2</sup> = 5mA. (3) I<sub>C</sub> = 200 μA, V<sub>CE</sub> = 2V, f = 1kHz. (4) I<sub>C</sub> = 100mA, V<sub>CE</sub> = 10V, I<sub>B</sub><sup>1</sup> = I<sub>B</sub><sup>2</sup> = 10mA. (5) I<sub>C</sub> = 10mA, V<sub>CE</sub> = 3V, I<sub>B</sub><sup>1</sup> = I<sub>B</sub><sup>2</sup> = 1mA. (6) I<sub>C</sub> = 100 μA, V<sub>CE</sub> = 5V, f = 1kHz. (7) I<sub>C</sub> = 1mA, V<sub>CE</sub> = 10V, f = 200kHz. (8) I<sub>C</sub> = 1mA, V<sub>CE</sub> = 5V, f = 1kHz. (9) I<sub>C</sub> = 150mA, V<sub>CE</sub> = 6V, I<sub>B</sub><sup>1</sup> = I<sub>B</sub><sup>2</sup> = 15mA. (10) I<sub>C</sub> = 200 μA, V<sub>CE</sub> = 5V, f = 1kHz. (11) I<sub>C</sub> = 150mA, V<sub>CE</sub> = 10V, I<sub>B</sub><sup>1</sup> = I<sub>B</sub><sup>2</sup> = 75mA. (12) I<sub>C</sub> = 300mA, V<sub>CE</sub> = 25V, I<sub>B</sub><sup>1</sup> = I<sub>B</sub><sup>2</sup> = 30mA. (13) I<sub>C</sub> = 10 μA, V<sub>CE</sub> = 5V, f = 100kHz. (14) I<sub>C</sub> = 500mA, V<sub>CE</sub> = 25V, I<sub>B</sub><sup>1</sup> = 50mA, I<sub>B</sub><sup>2</sup> = 25mA. (15) I<sub>C</sub> = 10mA, V<sub>BE</sub> = 2V, I<sub>B</sub><sup>1</sup> = 3mA, I<sub>B</sub><sup>2</sup> = 1mA. (16) I<sub>C</sub> = 100mA, I<sub>B</sub><sup>1</sup> = 40mA, I<sub>B</sub><sup>2</sup> = 20mA.

# Pro Electron Series



Type No.	Case Style	V <sub>CE</sub> * V <sub>CB</sub> (V) Min	V <sub>CE0</sub> (V) Min	V <sub>EB0</sub> (V) Min	I <sub>CE</sub> * I <sub>CB0</sub> (mA) Max	V <sub>CB</sub> (V)	HFE h <sub>FE</sub> 1 kHz* Min Max	I <sub>C</sub> & V <sub>CE</sub> (mA) (V) Min Max	V <sub>CE(SAT)</sub> (V) Max	V <sub>BE(SAT)</sub> & V <sub>BE(ON)*</sub> (V) Min Max	I <sub>C</sub> (mA) Min Max	C <sub>ob</sub> (pF) Max	f <sub>T</sub> (MHz) Min Max	t <sub>off</sub> (ns) Max	NF (dB) Max	Test Condition	Process No.
BC183L	TO-92 (74)	45	30	5	15	30	40 80 125	0.01 100 900* 2	0.6 0.25	1.2 0.70* 2	100 10 2	5	150		10	1	04
BC183LA	TO-92 (74)	45	30	5	15	30	40 80 125	0.01 100 260* 2	0.6 0.25	1.2 0.70* 2	100 10 2	5	150		10	1	04
BC183LB	TO-92 (74)	45	30	5	15	30	40 80 240	0.01 100 500* 2	0.6 0.25	1.2 0.70* 2	100 10 2	5	150		10	1	04
BC183LC	TO-92 (74)	45	30	5	15	30	40 80 450	0.01 100 900* 2	0.6 0.25	1.2 0.70* 2	100 10 2	5	150		10	1	04
BC184	TO-92 (77)	45	30	50	15	30	100 130 240	0.01 100 900* 2	0.6 0.25	1.2 0.70* 2	100 10 2	5	150		4	1	04
BC184B	TO-92 (77)	45	30	50	15	30	100 130 240	0.01 100 500* 2	0.6 0.25	1.2 0.70* 2	100 10 2	5	150		4	1	04
BC184C	TO-92 (77)	45	30	50	15	30	100 130 450	0.01 100 900* 2	0.6 0.25	1.2 0.70* 2	100 10 2	5	150		4	1	04
BC184L	TO-92 (74)	45	30	50	15	30	100 130 240	0.01 100 900* 2	0.6 0.25	1.2 0.70* 2	100 10 2	5	150		4	1	04
BC184LB	TO-92 (74)	45	30	50	15	30	100 130 240	0.01 100 500* 2	0.6 0.25	1.2 0.70* 2	100 10 2	5	150		4	1	04
BC184LC	TO-92 (74)	45	30	50	15	30	100 130 450	0.01 100 900* 2	0.6 0.25	1.2 0.70* 2	100 10 2	5	150		4	1	04
BC212	TO-92 (77)	60	50	5	15	30	60	400* 2	0.6 0.25	1.1 0.72* 2	100 10 2	10	200		10	1	63
BC212A	TO-92 (77)	60	50	5	15	30	100	300* 2	0.6 0.25	1.1 0.72* 2	100 10 2	10	200		10	1	63
BC212B	TO-92 (77)	60	50	5	15	30	200	400* 2	0.6 0.25	1.1 0.72* 2	100 10 2	10	200		10	1	63



Type No.	Case Style	V <sub>CE0</sub> <sup>*</sup> V <sub>CB0</sub> (V) Min	V <sub>EBO</sub> (V) Min	ICES <sup>*</sup> I <sub>CB0</sub> (mA) Max	V <sub>CB</sub> (V)	HFE h <sub>FE</sub> @ 1 kHz <sup>*</sup> Min Max	V <sub>CE(SAT)</sub> (V) Max	V <sub>BE(SAT)</sub> & V <sub>BE(ON)</sub> <sup>*</sup> (V) Min Max	I <sub>C</sub> (mA) Max	C <sub>ob</sub> (pF) Max	f <sub>T</sub> (MHz) Min Max	t <sub>off</sub> (ns) Max	NF (dB) Max	Test Condition	Process No.
BC212L	TO-92 (74)	60	5	15	30	40 60 300 2 5 60*	0.6 0.25	1.1 0.72*	100 10 2	10	200	10	10	1	63
BC212LA	TO-92 (74)	60	5	15	30	40 60 300* 2 5 100	0.6 0.25	1.1 0.72*	100 10 2	10	200	10	10	1	63
BC212LB	TO-92 (74)	60	5	15	30	40 60 400* 2 5 200	0.6 0.25	1.1 0.72*	100 10 2	10	200	10	10	1	63
BC213	TO-92 (77)	45	5	15	30	40 60 600* 2 5 80	0.6 0.25	1.1 0.72*	100 10 2	10	200	10	10	1	63
BC213A	TO-92 (77)	45	5	15	30	40 60 300* 2 5 100	0.6 0.25	1.1 0.72*	100 10 2	10	200	10	10	1	63
BC213B	TO-92 (77)	45	5	15	30	40 60 400* 2 5 200	0.6 0.25	1.1 0.72*	100 10 2	10	200	10	10	1	63
BC213C	TO-92 (77)	45	5	15	30	40 60 350 600* 2 5	0.6 0.25	1.1 0.72*	100 10 2	10	200	10	10	1	63
BC213L	TO-92 (74)	45	5	15	30	40 80 400 2 5 80*	0.6 0.25	1.1 0.72*	100 10 2	10	200	10	10	1	63
BC213LA	TO-92 (74)	45	5	15	30	40 80 300* 2 5 100	0.6 0.25	1.1 0.72*	100 10 2	10	200	10	10	1	63
BC213LB	TO-92 (74)	45	5	15	30	40 80 400* 2 5 200	0.6 0.25	1.1 0.72*	100 10 2	10	200	10	10	1	63

**TEST CONDITIONS:**

(1) I<sub>C</sub> = 200 μA, V<sub>CE</sub> = 5V, f = 1kHz. (2) I<sub>C</sub> = 100mA, V<sub>CC</sub> = 20V, I<sub>B</sub><sup>1</sup> = I<sub>B</sub><sup>2</sup> = 5mA. (3) I<sub>C</sub> = 200 μA, V<sub>CE</sub> = 2V, f = 1kHz. (4) I<sub>C</sub> = 100mA, V<sub>CC</sub> = 10V, I<sub>B</sub><sup>1</sup> = I<sub>B</sub><sup>2</sup> = 10mA. (5) I<sub>C</sub> = 10mA, V<sub>CC</sub> = 3V, I<sub>B</sub><sup>1</sup> = I<sub>B</sub><sup>2</sup> = 1mA. (6) I<sub>C</sub> = 100 μA, V<sub>CE</sub> = 5V, f = 1kHz. (7) I<sub>C</sub> = 1mA, V<sub>CE</sub> = 10V, f = 200kHz. (8) I<sub>C</sub> = 1mA, V<sub>CE</sub> = 5V, f = 1kHz. (9) I<sub>C</sub> = 150mA, V<sub>CC</sub> = 6V, I<sub>B</sub><sup>1</sup> = I<sub>B</sub><sup>2</sup> = 15mA. (10) I<sub>C</sub> = 200 μA, V<sub>CE</sub> = 5V, f = 1kHz. (11) I<sub>C</sub> = 150mA, V<sub>CC</sub> = 10V, I<sub>B</sub><sup>1</sup> = I<sub>B</sub><sup>2</sup> = 75mA. (12) I<sub>C</sub> = 300mA, V<sub>CC</sub> = 25V, I<sub>B</sub><sup>1</sup> = I<sub>B</sub><sup>2</sup> = 30mA. (13) I<sub>C</sub> = 10 μA, V<sub>CE</sub> = 5V, f = WB. (14) I<sub>C</sub> = 500mA, V<sub>CC</sub> = 25V, I<sub>B</sub><sup>1</sup> = 50mA, I<sub>B</sub><sup>2</sup> = 25mA. (15) I<sub>C</sub> = 10mA, V<sub>BE</sub> = 2V, I<sub>B</sub><sup>1</sup> = 3mA, I<sub>B</sub><sup>2</sup> = 1mA. (16) I<sub>C</sub> = 100mA, I<sub>B</sub><sup>1</sup> = 40mA, I<sub>B</sub><sup>2</sup> = 20mA.





Type No.	Case Style	V <sub>CE</sub> * V <sub>CB0</sub> (V) Min	V <sub>CEO</sub> (V) Min	V <sub>EB0</sub> (V) Min	I <sub>CE</sub> * I <sub>CB0</sub> @ V <sub>CB</sub> (mA) Max	H <sub>FE</sub> h <sub>FE</sub> @ I <sub>C</sub> & V <sub>CE</sub> 1 kHz* (mA) (V)		V <sub>CE(SAT)</sub> (V) Max		V <sub>BE(SAT)</sub> & V <sub>BE(ON)</sub> * (V) Min Max		I <sub>C</sub> (mA) Max	C <sub>ob</sub> (pF) Max	f <sub>T</sub> (MHz) Min Max		t <sub>off</sub> (ns) Max	NF (dB) Max	Test Condition	Process No.
						Min	Max	Min	Max	Min	Max			Min	Max				
BC213LC	TO-92 (74)	45	30	5	15	40 80 350	0.01 2 600*	5 5 5	0.6 0.25	1.1 0.72*	100 10 2	10	10	200	10		10	1	63
BC214	TO-92 (77)	45	30	5	15	40 80 140	0.01 2 600*	5 5 5	0.6 0.25	1.1 0.72*	100 10 2	10	10	200	10		2	1	63
BC214A	TO-92 (77)	45	30	5	15	40 80 100	0.01 2 300*	5 5 5	0.6 0.25	1.1 0.72*	100 10 2	10	10	200	10		2	1	63
BC214B	TO-92 (77)	45	30	5	15	40 80 200	0.01 2 400*	5 5 5	0.6 0.25	1.1 0.72*	100 10 2	10	10	200	10		2	1	63
BC214C	TO-92 (77)	45	30	5	15	40 80 350	0.01 2 600*	5 5 5	0.6 0.25	1.1 0.72*	100 10 2	10	10	200	10		2	1	63
BC214L	TO-92 (74)	45	30	5	15	100 140 120 140*	0.01 2 100 5 2	5 5 5 5	0.6 0.25	1.1 0.72*	100 10 2	10	10	200	10		2	1	63
BC214LB	TO-92 (74)	45	30	5	15	100 140 120 200	0.01 2 100 5 2	5 5 5 5	0.6 0.25	1.1 0.72*	100 10 2	10	10	200	10		2	1	63
BC214LC	TO-92 (74)	45	30	5	15	100 140 120 350	0.01 2 100 5 2	5 5 5 5	0.6 0.25	1.1 0.72*	100 10 2	10	10	200	10		2	1	63
BC237-92	TO-92 (77)	50	45	6	50	100 140 120 125	0.01 2 100 5 2	5 5 5 5	0.25	0.77* 0.6	10 100	4.5					10	1	04
BC237A-92	TO-92 (77)	50	45	6	50	100 140 120 125	0.01 2 100 5 2	5 5 5 5	0.25	0.55 0.70*	10 100	4.5					10	1	04
BC237B-92	TO-92 (77)	50	45	6	50	100 140 120 240	0.01 2 100 5 2	5 5 5 5	0.25	0.55 0.70*	10 100	4.5					10	1	04



Type No.	Case Style	V <sub>CE</sub> * V <sub>CB0</sub> (V) Min	V <sub>CE0</sub> (V) Min	V <sub>EB0</sub> (V) Min	ICES* I <sub>CB0</sub> (mA) Max	V <sub>CB</sub> (V)	HFE h <sub>FE</sub> @ 1 kHz* Min Max	I <sub>C</sub> & V <sub>CE</sub> (mA) (V)	V <sub>CE(SAT)</sub> (V) Max	V <sub>BE(SAT)</sub> & V <sub>BE(ON)*</sub> (V) Min Max	I <sub>C</sub> (mA) Max	C <sub>ob</sub> (pF) Max	f <sub>T</sub> (MHz) Min Max	f <sub>T</sub> @ I <sub>C</sub> (mA) Max	t <sub>off</sub> (ns) Max	NF (dB) Max	Test Condition	Process No.
BC238-92	TO-92 (77)	30	20	5	50	20	100 140 120 125	0.01 2 100 900*	0.25	0.77* 0.6 0.70*	10 100 2	4.5				10	1	04
BC238A-92	TO-92 (77)	30	20	5	50	20	100 140 120 125	0.01 2 100 900*	0.25	0.77* 0.6 0.70*	10 100 2	4.5				10	1	04
BC238B-92	TO-92 (77)	30	20	5	50	20	100 140 120 240	0.01 2 100 500*	0.25	0.77* 0.6 0.70*	10 100 2	4.5				10	1	04
BC238C-92	TO-92 (77)	30	20	5	50	20	100 140 120 450	0.01 2 100 900*	0.25	0.77* 0.6 0.70*	10 100 2	4.5				10	1	04
BC239-92	TO-92 (77)	30	20	5	50	20	100 140 120 240	0.01 2 100 900*	0.25	0.77* 0.6 0.70*	10 100 2	4.5				4	1	04
BC239B-92	TO-92 (77)	30	20	5	50	20	100 140 120 240	0.01 2 100 900*	0.25	0.77* 0.6 0.70*	10 100 2	4.5				4	1	04
BC239C-92	TO-92 (77)	30	20	5	50	20	100 140 120 450	0.01 2 100 900*	0.25	0.77* 0.6 0.70*	10 100 2	4.5				4	1	04
BC261A	TO-18		45		50	45	100 140 120 125	0.01 2 100 260*	0.25 0.6	0.9 0.9	10 100 2	4.5				6	3	71

**TEST CONDITIONS:**

(1) I<sub>C</sub> = 200 μA, V<sub>CE</sub> = 5V, f = 1kHz. (2) I<sub>C</sub> = 100mA, V<sub>CC</sub> = 20V, I<sub>B</sub><sup>1</sup> = I<sub>B</sub><sup>2</sup> = 5mA. (3) I<sub>C</sub> = 200 μA, V<sub>CE</sub> = 2V, f = 1kHz. (4) I<sub>C</sub> = 100mA, V<sub>CC</sub> = 10V, I<sub>B</sub><sup>1</sup> = I<sub>B</sub><sup>2</sup> = 10mA. (5) I<sub>C</sub> = 10mA, V<sub>CC</sub> = 3V, I<sub>B</sub><sup>1</sup> = I<sub>B</sub><sup>2</sup> = 1mA. (6) I<sub>C</sub> = 100 μA, V<sub>CE</sub> = 5V, f = 1kHz. (7) I<sub>C</sub> = 1mA, V<sub>CE</sub> = 10V, f = 200kHz. (8) I<sub>C</sub> = 1mA, V<sub>CE</sub> = 5V, f = 1kHz. (9) I<sub>C</sub> = 150mA, V<sub>CC</sub> = 6V, I<sub>B</sub><sup>1</sup> = I<sub>B</sub><sup>2</sup> = 15mA. (10) I<sub>C</sub> = 200 μA, V<sub>CE</sub> = 5V, f = 1kHz. (11) I<sub>C</sub> = 150mA, V<sub>CC</sub> = 10V, I<sub>B</sub><sup>1</sup> = I<sub>B</sub><sup>2</sup> = 75mA. (12) I<sub>C</sub> = 300mA, V<sub>CC</sub> = 25V, I<sub>B</sub><sup>1</sup> = I<sub>B</sub><sup>2</sup> = 30mA. (13) I<sub>C</sub> = 10 μA, V<sub>CE</sub> = 5V, f = 500mA, V<sub>CC</sub> = 25V, I<sub>B</sub><sup>1</sup> = 50mA, I<sub>B</sub><sup>2</sup> = 25mA. (15) I<sub>C</sub> = 10mA, V<sub>BE</sub> = 2V, I<sub>B</sub><sup>1</sup> = 3mA, I<sub>B</sub><sup>2</sup> = 1mA. (16) I<sub>C</sub> = 100mA, I<sub>B</sub><sup>1</sup> = 40mA, I<sub>B</sub><sup>2</sup> = 20mA.





Type No.	Case Style	V <sub>CE</sub> <sup>*</sup>		V <sub>BO</sub> (V) Min	V <sub>EB</sub> (V) Min	I <sub>CE</sub> <sup>*</sup>		h <sub>FE</sub> 1 kHz <sup>*</sup>	V <sub>CE(SAT)</sub> & V <sub>BE(ON)</sub> <sup>*</sup>		I <sub>C</sub>		C <sub>ob</sub> (pF) Max	f <sub>T</sub> (MHz)		t <sub>off</sub> (ns) Max	NF (dB) Max	Test Condition	Process No.
		Min	Max			I <sub>CB0</sub> (mA) Max	V <sub>CE</sub> (V) Max		I <sub>C</sub> (mA) Max	V <sub>CE(SAT)</sub> (V) Max	V <sub>BE(ON)</sub> (V) Min	Min		Max	Min				
BC261B	TO-18	45				50	45	100 140 120 240	0.01 2 100 500*	0.25 0.6	0.9 100	10 100					6	3	71
BC262A	TO-18	20		5		50	20	100 140 120 240	0.01 2 100 500*	0.25	0.9 10	10					6	3	71
BC262B	TO-18	20		5		50	20	100 140 120 240	0.01 2 100 500*	0.25 0.6	0.9 10	10 100					6	3	71
BC263A	TO-18	20		5		50	20	100 140 120 240	0.01 2 100 500*	0.25	0.9 10	10					2.5	3	71
BC263B	TO-18	20		5		50	20	100 140 120 240	0.01 2 100 500*	0.25 0.6	0.9 10	10 100					2.5	3	71
BC307-92	TO-92 (77)	50		5		100	20	100 140 120 75	0.01 2 100 500*	0.18	0.78 1.0*	10 100					10	1	71
BC307A-92	TO-92 (77)	50		5		100	20	100 140 120 240	0.01 2 100 500*	0.18	0.78 1.0*	10 100					10	1	71
BC307B-92	TO-92 (77)	50		5		100	20	100 140 120 240	0.01 2 100 500*	0.18	0.78 1.0*	10 100					10	1	71
BC308-92	TO-92 (77)	30		5		100	20	100 140 120 240	0.01 2 100 500*	0.18	0.78 1.0*	10 100					10	1	71
BC308A-92	TO-92 (77)	30		5		100	20	100 140 120 240	0.01 2 100 500*	0.18	0.78 1.0*	10 100					10	1	71



Type No.	Case Style	V <sub>CE</sub> <sup>*</sup> V <sub>CB0</sub> (V) Min	V <sub>CE0</sub> (V) Min	V <sub>EB0</sub> (V) Min	I <sub>CB0</sub> <sup>*</sup> (mA) Max	V <sub>CB</sub> (V)	H <sub>FE</sub> h <sub>FE</sub> 1 kHz <sup>*</sup> Min Max	I <sub>C</sub> & V <sub>CE</sub> (mA) (V) Max	V <sub>CE(SAT)</sub> (V) Max	V <sub>BE(SAT)</sub> & V <sub>BE(ON)</sub> <sup>*</sup> (V) (V) Min Max	I <sub>C</sub> (mA) Max	C <sub>ob</sub> (pF) Max	f <sub>T</sub> (MHz) Min Max	I <sub>C</sub> (mA) Max	t <sub>off</sub> (ns) Max	NF (dB) Max	Test Condition	Process No.
BC308B-92	TO-92 (77)	30	25	5	100	20	100 400 120 240	0.01 400 100 500 <sup>*</sup>	0.18	0.78 1.0 <sup>*</sup> 0.75 <sup>*</sup>	10 100 2					10	1	71
BC308C-92	TO-92 (77)	30	25	5	100	20	100 400 120 450	0.01 400 100 900 <sup>*</sup>	0.18	0.78 1.0 <sup>*</sup> 0.75 <sup>*</sup>	10 100 2					10	1	71
BC309-92	TO-92 (77)	25	20	5	100	20	100 400 120 125	0.01 400 100 900 <sup>*</sup>	0.18	0.78 1.0 0.75	10 100 2					4	1	71
BC309B-92	TO-92 (77)	25	20	5	100	20	100 140 120 240	0.01 2 100 500 <sup>*</sup>	0.18	0.78 1.0 0.75	10 100 2					4	1	71
BC309C-92	TO-92 (77)	25	20	5	100	20	100 140 120 450	0.01 2 100 900 <sup>*</sup>	0.8	0.78 1.0 0.75	10 100 2					4	1	71
BC317	TO-92 (72)	50	45	6	30	20	110 125	450 500 <sup>*</sup>	0.2 0.5	0.77 <sup>*</sup> 0.57	10 100	4				6	1	04
BC317A	TO-92 (72)	50	45	6	30	20	110 125	220 260 <sup>*</sup>	0.2 0.5	0.77 <sup>*</sup> 0.57	10 100	4				6	1	04
BC317B	TO-92 (72)	50	45	6	30	20	200 240	450 500 <sup>*</sup>	0.2 0.5	0.77 <sup>*</sup> 0.57	10 100	4				6	1	04
BC318	TO-92 (72)	30	20	5	30	20	110 125	800 900 <sup>*</sup>	0.2 0.5	0.77 <sup>*</sup> 0.57	10 100	4				6	1	04
BC318A	TO-92 (72)	30	20	5	30	20	110 125	220 260 <sup>*</sup>	0.2 0.5	0.77 <sup>*</sup> 0.57	10 100	4				6	1	04

**TEST CONDITIONS:**

(1) I<sub>C</sub> = 200 μA, V<sub>CE</sub> = 5V, f = 1kHz. (2) I<sub>C</sub> = 100mA, V<sub>CE</sub> = 20V, I<sub>B</sub><sup>1</sup> = I<sub>B</sub><sup>2</sup> = 5mA. (3) I<sub>C</sub> = 200 μA, V<sub>CE</sub> = 2V, f = 1kHz. (4) I<sub>C</sub> = 100mA, V<sub>CE</sub> = 10V, I<sub>B</sub><sup>1</sup> = I<sub>B</sub><sup>2</sup> = 10mA. (5) I<sub>C</sub> = 10mA, V<sub>CE</sub> = 3V, I<sub>B</sub><sup>1</sup> = I<sub>B</sub><sup>2</sup> = 1mA. (6) I<sub>C</sub> = 100 μA, V<sub>CE</sub> = 5V, f = 1kHz. (7) I<sub>C</sub> = 1mA, V<sub>CE</sub> = 10V, f = 200kHz. (8) I<sub>C</sub> = 1mA, V<sub>CE</sub> = 5V, f = 1kHz. (9) I<sub>C</sub> = 150mA, V<sub>CE</sub> = 6V, I<sub>B</sub><sup>1</sup> = I<sub>B</sub><sup>2</sup> = 15mA. (10) I<sub>C</sub> = 200 μA, V<sub>CE</sub> = 5V, f = 1kHz. (11) I<sub>C</sub> = 150mA, V<sub>CE</sub> = 10V, I<sub>B</sub><sup>1</sup> = I<sub>B</sub><sup>2</sup> = 75mA. (12) I<sub>C</sub> = 300mA, V<sub>CE</sub> = 25V, I<sub>B</sub><sup>1</sup> = I<sub>B</sub><sup>2</sup> = 30mA. (13) I<sub>C</sub> = 10 μA, V<sub>CE</sub> = 5V, f = 100kHz. (14) I<sub>C</sub> = 500mA, V<sub>CE</sub> = 25V, I<sub>B</sub><sup>1</sup> = 50mA, I<sub>B</sub><sup>2</sup> = 25mA. (15) I<sub>C</sub> = 10mA, V<sub>BE</sub> = 2V, I<sub>B</sub><sup>1</sup> = 3mA, I<sub>B</sub><sup>2</sup> = 1mA. (16) I<sub>C</sub> = 100mA, I<sub>B</sub><sup>1</sup> = 40mA, I<sub>B</sub><sup>2</sup> = 20mA.



Type No.	Case Style	V <sub>CE5</sub> <sup>*</sup> V <sub>CB0</sub> (V) Min	V <sub>CE0</sub> (V) Min	V <sub>EO</sub> (V) Min	I <sub>CE5</sub> <sup>*</sup> I <sub>CB0</sub> (mA) Max	V <sub>CB</sub> (V)	h <sub>FE</sub> h <sub>FE</sub> @ 1 kHz* Min Max	I <sub>C</sub> & V <sub>CE</sub> (mA) (V)	V <sub>CE</sub> (SAT) (V) Max	V <sub>BE</sub> (SAT) & V <sub>BE</sub> (ON)* (V) Min Max	I <sub>C</sub> (mA) Max	C <sub>ob</sub> (pF) Max	f <sub>T</sub> (MHz) Min Max	t <sub>off</sub> (ns) Max	NF (dB) Max	Test Condition	Process No.
BC318B	TO-29 (72)	30	20	5	30	20	200 480* 2 240 500* 2	5 5	0.2 0.5	0.77* 0.72* 2	10 100	4			6	1	04
BC318C	TO-92 (72)	30	20	5	30	20	100 450 800 2 450 900* 2	5 5	0.2 0.5	0.77* 0.72* 2	10 100	4			6	1	04
BC319	TO-92 (72)	30	20	5	30	20	40 200 800 2 240 900* 2	5 5	0.2 0.5	0.77* 0.72* 2	10 100	4			4	1	04
BC319B	TO-92 (72)	30	20	5	30	20	200 450 500* 2	5 5	0.2 0.5	0.77* 0.72* 2	10 100	4			4	1	04
BC319C	TO-92 (72)	30	20	5	30	20	100 420 800 2 450 900* 2	5 5	0.2 0.5	0.77* 0.72* 2	10 100	4			4	1	04
BC327	TO-92 (77)	50†	45	5	100†	45	40 100 600 100 1	1	0.7	12* 300	500 300	4			4	1	67
BC327-10	TO-92 (77)	50†	45	5	100†	45	40 63 160 100 1	1	0.7	1.2* 300	500 300	4			4	1	67
BC327-16	TO-92 (77)	50†	45	5	100†	45	40 100 250 100 1	1	0.7	1.2* 300	500 300	4			4	1	67
BC327-25	TO-92 (77)	50†	45	5	100†	45	40 160 400 100 1	1	0.7	1.2* 300	500 300	4			4	1	67
BC328	TO-92 (77)	30†	25	5	100†	25	40 100 600 100 1	1	0.7	1.2 300	500 300	4			4	1	67
BC328-10	TO-92 (77)	30†	25	5	100†	25	40 63 160 100 1	1	0.7	1.2 300	500 300	4			4	1	67
BC328-16	TO-92 (77)	30†	25	5	100†	25	40 100 250 100 1	1	0.7	1.2 300	500 300	4			4	1	67
BC328-25	TO-92 (77)	30†	25	5	100†	25	40 160 400 100 1	1	0.7	1.2 300	500 300	4			4	1	67
BC337	TO-92 (77)	50†	45	5	100†	45	40 100 600 100 1	1	0.7	1.2* 300	500 300	4			4	1	14
BC337-10	TO-92 (77)	50†	45	5	100†	45	40 63 160 100 1	1	0.7	1.2* 300	500 300	4			4	1	14
BC337-16	TO-92 (77)	50†	45	5	100†	45	40 100 250 100 1	1	0.7	1.2* 300	500 300	4			4	1	14
BC337-25	TO-92 (77)	50†	45	5	100†	45	40 160 400 100 1	1	0.7	1.2* 300	500 300	4			4	1	14





Type No.	Case Style	V <sub>CE</sub> <sup>*</sup> V <sub>CB0</sub> (V) Min	V <sub>CE0</sub> (V) Min	V <sub>EB0</sub> (V) Min	I <sub>CB0</sub> <sup>*</sup> (mA) Max	V <sub>CB</sub> (V)	h <sub>FE</sub> 1 kHz <sup>*</sup>		I <sub>C</sub> & V <sub>CE</sub> (mA) (V)		V <sub>CE(SAT)</sub> (V) Max		V <sub>BE(SAT)</sub> & V <sub>BE(ON)</sub> <sup>*</sup> (V) Min Max		C <sub>ob</sub> (pF) Max	f <sub>T</sub> (MHz) Min Max	t <sub>off</sub> (ns) Max	NF (dB) Max	Test Condition	Process No.
							Min	Max	Min	Max	Min	Max	Min	Max						
BC338	TO-92 (77)	30 <sup>†</sup>	25	5	100 <sup>†</sup>	25	40 100	300 100	1 1	0.7	0.7	1.2 <sup>*</sup>	500 300	4			4	1	14	
BC338-10	TO-92 (77)	30 <sup>†</sup>	25	5	100 <sup>†</sup>	25	40 63	300 100	1 1	0.7	0.7	1.2 <sup>*</sup>	500 300	4			4	1	14	
BC338-16	TO-92 (77)	30 <sup>†</sup>	25	5	100 <sup>†</sup>	25	40 100	300 100	1 1	0.7	0.7	1.2 <sup>*</sup>	500 300	4			4	1	14	
BC338-25	TO-92 (77)	30 <sup>†</sup>	25	5	100 <sup>†</sup>	25	40 160	300 100	1 1	0.7	0.7	1.2 <sup>*</sup>	500 300	4			4	1	14	
BC485	TO-92 (77)	45	45	5	100	30	15 40 60	1A 10 100	5 2 2	0.5	0.5	1.2 .12 <sup>*</sup>	500 300	4			4	1	14	
BC485A	TO-92 (77)	45	45	5	100	30	15 40 100	1A 10 250	5 2 2	0.5	0.5	1.2 1.2 <sup>*</sup>	500 300	4			4	1	14	
BC485B	TO-92 (77)	45	45	5	100	30	15 40 160	1A 10 400	5 2 2	0.5	0.5	1.2 1.2 <sup>*</sup>	500 300	4			4	1	14	
BC485L	TO-92 (77)	45	45	5	100	30	15 40 60	1A 10 150	5 2 2	0.5	0.5	1.2 1.2 <sup>*</sup>	500 300	4			4	1	14	
BC547	TO-92 (77)	50	45	6	10	20	125	500 <sup>*</sup>	2 5	0.25 0.6	0.55	0.77 <sup>*</sup> 0.70 <sup>*</sup>	10 100	4.5			10	1	04	
BC547A	TO-92 (77)	50	45	6	10	20	125	260 <sup>*</sup>	2 5	0.25 0.6	0.55	0.77 <sup>*</sup> 0.70 <sup>*</sup>	10 100	4.5			10	1	04	
BC547B	TO-92 (77)	50	45	6	10	20	240	500 <sup>*</sup>	2 5	0.25 0.6	0.55	0.77 <sup>*</sup> 0.70 <sup>*</sup>	10 100	4.5			10	1	04	
BC547C	TO-92 (77)	50	45	6	10	20	450	900 <sup>*</sup>	2 5	0.25 0.6	0.55	0.77 <sup>*</sup> 0.70 <sup>*</sup>	10 100	4.5			10	1	04	

**TEST CONDITIONS:**

(1) I<sub>C</sub> = 200 μA, V<sub>CE</sub> = 5V, f = 1kHz. (2) I<sub>C</sub> = 100mA, V<sub>CC</sub> = 20V, I<sub>B</sub><sup>1</sup> = I<sub>B</sub><sup>2</sup> = 5mA. (3) I<sub>C</sub> = 200 μA, V<sub>CE</sub> = 2V, f = 1kHz. (4) I<sub>C</sub> = 100mA, V<sub>CC</sub> = 10V, I<sub>B</sub><sup>1</sup> = I<sub>B</sub><sup>2</sup> = 10mA. (5) I<sub>C</sub> = 10mA, V<sub>CC</sub> = 3V, I<sub>B</sub><sup>1</sup> = I<sub>B</sub><sup>2</sup> = 1mA. (6) I<sub>C</sub> = 100 μA, V<sub>CE</sub> = 5V, f = 1kHz. (7) I<sub>C</sub> = 1mA, V<sub>CE</sub> = 10V, f = 20kHz. (8) I<sub>C</sub> = 1mA, V<sub>CE</sub> = 5V, f = 1kHz. (9) I<sub>C</sub> = 150mA, V<sub>CC</sub> = 6V, I<sub>B</sub><sup>1</sup> = I<sub>B</sub><sup>2</sup> = 15mA. (10) I<sub>C</sub> = 200 μA, V<sub>CE</sub> = 5V, f = 1kHz. (11) I<sub>C</sub> = 150mA, V<sub>CC</sub> = 10V, I<sub>B</sub><sup>1</sup> = I<sub>B</sub><sup>2</sup> = 75mA. (12) I<sub>C</sub> = 300mA, V<sub>CC</sub> = 25V, I<sub>B</sub><sup>1</sup> = I<sub>B</sub><sup>2</sup> = 30mA. (13) I<sub>C</sub> = 10 μA, V<sub>CE</sub> = 5V, f = WB. (14) I<sub>C</sub> = 500mA, V<sub>CC</sub> = 25V, I<sub>B</sub><sup>1</sup> = 50mA, I<sub>B</sub><sup>2</sup> = 25mA. (15) I<sub>C</sub> = 10mA, V<sub>BE</sub> = 2V, I<sub>B</sub><sup>1</sup> = 3mA, I<sub>B</sub><sup>2</sup> = 1mA. (16) I<sub>C</sub> = 100mA, I<sub>B</sub><sup>1</sup> = 40mA, I<sub>B</sub><sup>2</sup> = 20mA.





Type No.	Case Style	V <sub>CE</sub> * VCBO (V) Min	V <sub>CE0</sub> (V) Min	V <sub>EB0</sub> (V) Min	I <sub>CE</sub> * ICBO (mA) Max	V <sub>CB</sub> (V) Min	HFE h <sub>FE</sub> @ 1 kHz* Min	I <sub>C</sub> & V <sub>CE</sub> (mA) (V) Max	V <sub>CE(SAT)</sub> (V) Max	V <sub>BE(SAT)</sub> & V <sub>BE(ON)*</sub> (V) Min	I <sub>C</sub> (mA) Max	C <sub>ob</sub> (pF) Max	f <sub>T</sub> (MHz) Min	f <sub>T</sub> (MHz) Max	t <sub>off</sub> (ns) Max	NF (dB) Max	Test Condition	Process No.
BC548	TO-92 (77)	30	20	5	10	20	125	900* 2	0.25 0.6	0.77* 0.55 0.70* 2	10 100	4.5				10	1	04
BC548A	TO-92 (77)	30	20	5	10	20	125	260* 2	0.25 0.6	0.77* 0.55 0.70* 2	10 100	4.5				10	1	04
BC548B	TO-92 (77)	30	20	5	10	20	240	500* 2	0.25 0.6	0.77* 0.55 0.70* 2	10 100	4.5				10	1	04
BC548C	TO-92 (77)	30	20	5	10	20	450	900* 2	0.25 0.6	0.77* 0.55 0.70* 2	10 100	4.5				10	1	04
BC549	TO-92 (77)	30	20	5	10	20	240	900* 2	0.25 0.6	0.77* 0.55 0.70* 2	10 100	4.5				4	1	04
BC549B	TO-92 (77)	30	20	5	10	20	240	500* 2	0.25 0.6	0.77* 0.55 0.70* 2	10 100	4.5				4	1	04
BC549C	TO-92 (77)	30	20	5	10	20	450	900* 2	0.25 0.6	0.77* 0.55 0.70* 2	10 100	4.5				4	1	04
BC550	TO-92 (77)	50	45	5	10	45	240	900* 2	0.25 0.6	0.77* 0.55 0.70* 2	10 100					3	1	04
BC550B	TO-92 (77)	50	45	5	10	45	240	500* 2	0.25 0.6	0.77* 0.55 0.70* 2	10 100					3	1	04
BC550C	TO-92 (77)	50	45	5	10	45	450	900* 2	0.25 0.6	0.77* 0.55 0.70* 2	10 100					3	1	04
BC557	TO-92 (77)	50	45	5	100	20	75	260* 2	0.3 0.65	0.82* 0.6 0.75* 2	10 100					10	1	71
BC557A	TO-92 (77)	50	45	5	100	20	125	260* 2	0.3 0.65	0.82* 0.6 0.75* 2	10 100					10	1	71
BC557B	TO-92 (77)	50	45	5	100	20	240	500* 2	0.3 0.65	0.82* 0.6 0.75* 2	10 100					10	1	71



Type No.	Case Style	V <sub>CE</sub> <sup>*</sup>		V <sub>CEO</sub> (V) Min	V <sub>EB0</sub> (V) Min	I <sub>CB0</sub> (mA) Max	I <sub>CB0</sub> @ V <sub>CB</sub> (V)	h <sub>FE</sub>		I <sub>C</sub> & V <sub>CE</sub> (V)	V <sub>CE</sub> (SAT) (V)		V <sub>BE</sub> (SAT) & V <sub>BE</sub> (ON) <sup>*</sup> (V)		I <sub>C</sub> (mA) Max	C <sub>ob</sub> (pF) Max	f <sub>T</sub> (MHz) Min	f <sub>T</sub> (MHz) Max	t <sub>off</sub> (ns) Max	NF (dB) Max	Test Condition	Process No.
		V <sub>CB0</sub> (V) Min	V <sub>CE0</sub> (V) Min					Min	Max		Min	Max	Min	Max								
BC558	TO-92 (77)	30	25	5	5	100	20	75	500* 2	5	0.3 0.65	0.82* 10	10							10	1	71
BC558A	TO-92 (77)	30	25	5	5	100	20	125	260* 2	5	0.3 0.65	0.82* 10	10							10	1	71
BC558B	TO-92 (77)	30	25	5	5	100	20	240	500* 2	5	0.3 0.65	0.82* 10	10							10	1	71
BC558C	TO-92 (77)	30	25	5	5	100	20	450	900* 2	5	0.3 0.65	0.82* 10	10							10	1	71
BC559	TO-92 (77)	25	20	5	5	100	20	125	500* 2	5	0.3 0.65	0.82* 10	10							4	1	71
BC559A	TO-92 (77)	25	20	5	5	100	20	125	260* 2	5	0.3 0.65	0.82* 10	10							4	1	71
BC559B	TO-92 (77)	25	20	5	5	100	20	240	500* 2	5	0.3 0.65	0.82* 10	10							4	1	71
BC559C	TO-92 (77)	25	20	5	5	100	20	450	900* 2	5	0.3 0.65	0.82* 10	10							4	1	71
BC560	TO-92 (77)	50	45	5	5	100	45	125	500* 2	5	0.3 0.65	0.82* 10	10							2	1	71
BC560A	TO-92 (77)	50	45	5	5	100	45	125	260* 2	5	0.3 0.65	0.82* 10	10							2	1	71
BC560B	TO-92 (77)	50	45	5	5	100	45	240	500* 2	5	0.3 0.65	0.82* 10	10							2	1	71

**TEST CONDITIONS:**

(1) I<sub>C</sub> = 200 μA, V<sub>CE</sub> = 5V, f = 1kHz. (2) I<sub>C</sub> = 100mA, V<sub>CC</sub> = 20V, I<sub>B</sub><sup>1</sup> = I<sub>B</sub><sup>2</sup> = 5mA. (3) I<sub>C</sub> = 200 μA, V<sub>CE</sub> = 2V, f = 1kHz. (4) I<sub>C</sub> = 100mA, V<sub>CC</sub> = 10V, I<sub>B</sub><sup>1</sup> = I<sub>B</sub><sup>2</sup> = 10mA. (5) I<sub>C</sub> = 10mA, V<sub>CC</sub> = 3V, I<sub>B</sub><sup>1</sup> = I<sub>B</sub><sup>2</sup> = 1mA. (6) I<sub>C</sub> = 100 μA, V<sub>CE</sub> = 5V, f = 1kHz. (7) I<sub>C</sub> = 1mA, V<sub>CE</sub> = 10V, f = 200kHz. (8) I<sub>C</sub> = 1mA, V<sub>CE</sub> = 5V, f = 1kHz. (9) I<sub>C</sub> = 150mA, V<sub>CC</sub> = 6V, I<sub>B</sub><sup>1</sup> = I<sub>B</sub><sup>2</sup> = 15mA. (10) I<sub>C</sub> = 200 μA, V<sub>CE</sub> = 5V, f = 1kHz. (11) I<sub>C</sub> = 150mA, V<sub>CC</sub> = 10V, I<sub>B</sub><sup>1</sup> = I<sub>B</sub><sup>2</sup> = 75mA. (12) I<sub>C</sub> = 300mA, V<sub>CC</sub> = 25V, I<sub>B</sub><sup>1</sup> = I<sub>B</sub><sup>2</sup> = 30mA. (13) I<sub>C</sub> = 10 μA, V<sub>CE</sub> = 5V, f = WB. (14) I<sub>C</sub> = 500mA, V<sub>CC</sub> = 25V, I<sub>B</sub><sup>1</sup> = 50mA, I<sub>B</sub><sup>2</sup> = 25mA. (15) I<sub>C</sub> = 10mA, V<sub>BE</sub> = 2V, I<sub>B</sub><sup>1</sup> = 3mA, I<sub>B</sub><sup>2</sup> = 1mA. (16) I<sub>C</sub> = 100mA, I<sub>B</sub><sup>1</sup> = 40mA, I<sub>B</sub><sup>2</sup> = 20mA.



Type No.	Case Style	V <sub>CE(S)</sub> V <sub>CB0</sub> (V) Min	V <sub>CE0</sub> (V) Min	V <sub>EB0</sub> (V) Min	I <sub>CE(S)</sub> I <sub>CB0</sub> (mA) Max	V <sub>CB</sub> (V)	f <sub>FE</sub> h <sub>FE</sub> @ 1 kHz* Min Max	I <sub>C</sub> & V <sub>CE</sub> (V) (mA) (V) Min Max	V <sub>CE(SAT)</sub> (V) Max	V <sub>BE(SAT)</sub> & V <sub>BE(ON)</sub> * (V) Min Max	I <sub>C</sub> (mA) Min Max	C <sub>ob</sub> (pF) Max	f <sub>T</sub> (MHz) Min Max	I <sub>C</sub> (mA) Max	t <sub>off</sub> (ns) Max	NF (dB) Max	Test Condition	Process No.
BC560C	TO-92 (77)	50	45	5	100	45	450 900* 2	0.3 0.65	0.82* 0.75* 2	10 100						2	1	71
BCY56	TO-18	45	45	5	100	20	40 100 450 2 125 500* 2 40		0.6 0.7* 2	2						5	1	04
BCY57	TO-18	25	20	5	100	20	200 200 240 900* 2 100		0.6 0.7* 2	2						5	1	04
BCY58	TO-18		32	7	10 <sup>†</sup>	32	40 80 1000 10 125 700* 2	0.35 0.7	0.6 0.75 1.2 0.55 0.7* 2	10 100	6	125	10	800		6	4/1	04
BCY58-7	TO-18		32	7	10 <sup>†</sup>	32	40 80 1000 10 125 250* 2	0.35 0.7	0.6 0.75 1.2 0.55 0.7* 2	10 100	6	125	10	800		6	4/1	04
BCY58-8	TO-18		32	7	10 <sup>†</sup>	32	40 80 1000 10 175 350* 2	0.35 0.7	0.6 0.75 1.2 0.55 0.7* 2	10 100	6	125	10	800		6	4/1	04
BCY58-9	TO-18		32	7	10 <sup>†</sup>	32	40 80 1000 10 250 500* 2	0.35 0.7	0.6 0.75 1.2 0.55 0.7* 2	10 100	6	125	10	800		6	4/1	04
BCY58-10	TO-18		32	7	10 <sup>†</sup>	32	40 80 1000 10 350 700* 2	0.35 0.7	0.6 0.75 1.2 0.55 0.7* 2	10 100	6	125	10	800		6	4/1	04
BCY59	TO-18		45	7	10 <sup>†</sup>	45	40 80 1000 10 125 700* 2	0.35 0.7	0.6 0.75 1.2 0.55 0.7* 2	10 100	6	125	10	800		6	4/1	04
BCY59-7	TO-18		45	7	10 <sup>†</sup>	45	40 80 1000 10 125 250* 2	0.35 0.7	0.6 0.75 1.2 0.55 0.7* 2	10 100	6	125	10	800		6	4/1	04
BCY59-8	TO-18		45	7	10 <sup>†</sup>	45	40 80 1000 10 175 350* 2	0.35 0.7	0.6 0.75 1.2 0.55 0.7* 2	10 100	6	125	10	800		6	4/1	04
BCY59-9	TO-18		45	7	10 <sup>†</sup>	45	40 80 1000 10 250 500* 2	0.35 0.7	0.6 0.75 1.2 0.55 0.7* 2	10 100	6	125	10	800		6	4/1	04
BCY59-10	TO-18		45	7	10 <sup>†</sup>	45	40 80 1000 10 350 700* 2	0.35 0.7	0.6 0.75 1.2 0.55 0.7* 2	10 100	6	125	10	800		6	4/1	04



Type No.	Case Style	V <sub>CE5</sub> <sup>*</sup> V <sub>CE0</sub> (V) Min	V <sub>CE0</sub> (V) Min	V <sub>BE0</sub> (V) Min	I <sub>CE5</sub> <sup>*</sup> I <sub>CB0</sub> (nA) @ Max	V <sub>CB</sub> (V) Min	HFE h <sub>FE</sub> @ 1 kHz Min	HFE h <sub>FE</sub> @ 1 kHz Max	V <sub>CE(SAT)</sub> (V) Max	V <sub>BE(SAT)</sub> & V <sub>BE(ON)</sub> <sup>*</sup> (V) Min	I <sub>C</sub> (mA) @ Max	C <sub>ob</sub> (pF) Max	f <sub>T</sub> (MHz) Min	f <sub>T</sub> (MHz) Max	t <sub>off</sub> (ns) Max	NF (dB) Max	Test Condition	Process No.
BCV70	TO-18	50	40	5	10	40	40	0.1	0.25	0.6	0.9	6	250	10	420	6	5/6	71
BCV71	TO-18	45	45	5	500	45	40	0.01	0.25	0.6	0.9	6	200	10		2	6	71
BCV71A	TO-18	45	45	5	500	45	40	0.01	0.25	0.6	0.9	6	300	10	420	2	6	71
BCV72	TO-18	25	25	5	500	20	40	0.1	0.25	1.0	1.2	6	200	10	420	6	5/6	71
BD135	TO-126	45	45	5	100	30	25	500	0.5	1.0*	500		50	50	420	6	5/6	37
BC136	TO-126	45	45	5	100	30	25	500	0.5	1.0*	500		50	50				77
BD137	TO-126	60	60	5	100	30	25	500	0.5	1.0*	500		50	50	420	6	5/6	38
BD138	TO-126	60	60	5	100	30	25	500	0.5	1.0*	500		50	50				78
BD139	TO-126	80	80	5	100	30	25	500	0.5	1.0*	500		50	50	420	6	5/6	39
BD140	TO-126	80	80	5	100	30	25	500	0.5	1.0*	500		50	50	420	6	5/6	79
BD201	TO-220	60	45	5	10 μA	40	30	3A	1.0	1.5*	3A	3	3	300	420	6	5/6	4A
BD202	TO-220	60	45	5	10 μA	40	30	3A	1.0	1.5*	3A	3	3	300	420	6	5/6	5A
BD233	TO-126	45	45		100 μA	45	25	150	0.6	1.3*	1A	3	3	250	420	6	5/6	2C

**TEST CONDITIONS:**

(1) I<sub>C</sub> = 200 μA, V<sub>CE</sub> = 5V, f = 1kHz. (2) I<sub>C</sub> = 100mA, V<sub>CE</sub> = 20V, I<sub>B</sub> = I<sub>B2</sub> = 5mA. (3) I<sub>C</sub> = 200 μA, V<sub>CE</sub> = 2V, f = 1kHz. (4) I<sub>C</sub> = 100mA, V<sub>CE</sub> = 10V, I<sub>B</sub> = I<sub>B2</sub> = 10mA. (5) I<sub>C</sub> = 10mA, V<sub>CE</sub> = 3V, I<sub>B</sub> = I<sub>B2</sub> = 1mA. (6) I<sub>C</sub> = 100 μA, V<sub>CE</sub> = 5V, f = 1kHz. (7) I<sub>C</sub> = 1mA, V<sub>CE</sub> = 10V, f = 200kHz. (8) I<sub>C</sub> = 1mA, V<sub>CE</sub> = 5V, f = 1kHz. (9) I<sub>C</sub> = 150mA, V<sub>CE</sub> = 6V, I<sub>B</sub> = I<sub>B2</sub> = 15mA. (10) I<sub>C</sub> = 200 μA, V<sub>CE</sub> = 5V, f = 1kHz. (11) I<sub>C</sub> = 150mA, V<sub>CE</sub> = 10V, I<sub>B</sub> = I<sub>B2</sub> = 75mA. (12) I<sub>C</sub> = 300mA, V<sub>CE</sub> = 25V, I<sub>B</sub> = I<sub>B2</sub> = 30mA. (13) I<sub>C</sub> = 10 μA, V<sub>CE</sub> = 5V, f = WB. (14) I<sub>C</sub> = 500mA, V<sub>CE</sub> = 25V, I<sub>B</sub> = 50mA, I<sub>B2</sub> = 25mA. (15) I<sub>C</sub> = 10mA, V<sub>BE</sub> = 2V, I<sub>B</sub> = 3mA, I<sub>B2</sub> = 1mA. (16) I<sub>C</sub> = 100mA, I<sub>B</sub> = 40mA, I<sub>B2</sub> = 20mA.



Type No.	Case Style	V <sub>CE0</sub> <sup>*</sup> V <sub>CB0</sub> (V) Min	V <sub>CE0</sub> (V) Min	V <sub>EB0</sub> (V) Min	I <sub>CB0</sub> <sup>*</sup> I <sub>CB0</sub> (mA) Max	V <sub>CB</sub> (V)	HFE h <sub>FE</sub> 1 kHz Min Max	I <sub>C</sub> & V <sub>CE</sub> (mA) (V) Max	V <sub>CE(SAT)</sub> (V) Max	V <sub>BE(SAT)</sub> & V <sub>BE(ON)</sub> <sup>*</sup> (V) (V) Min Max	I <sub>C</sub> (mA) Max	C <sub>ob</sub> (pF) Max	f <sub>T</sub> (MHz) Min Max	I <sub>C</sub> (mA) Max	t <sub>off</sub> (ns) Max	NF (dB) Max	Test Condition	Process No.
BD234	TO-126	45	45		100 μA	45	25 40	1A 2 150 2	0.6	1.3*	1A		3	250	420	6	5/6	3C
BD235	TO-126	60	60		100 μA	60	25 40	1A 2 150 2	0.6	1.3*	1A		3	250	420	6	5/6	2C
BD236	TO-126	60	60		100 μA	60	25 40	1A 2 150 2	0.6	1.3*	1A		3	250	420	6	5/6	3C
BD237	TO-126	80	80		100 μA	80	25 40	1A 2 150 2	0.6	1.3*	1A		3	250	420	6	5/6	2C
BD238	TO-126		80		100 μA	80	25 40	1A 2 150 2	0.6	1.3*	1A		3	250	420	6	5/6	3C
BD239	TO-220		45		200 μA*	45	15 40	1A 4 200 4	0.7	1.3*	1A		3	200	420	6	5/6	4F(2C)
BD239A	TO-220		60		200 μA*	60	15 40	1A 4 200 4	0.7	1.3*	1A		3	200	420	6	5/6	4F(2C)
BD239B	TO-220		80		200 μA*	80	15 40	1A 4 200 4	0.7	1.3*	1A		3	200	420	6	5/6	4F(2C)
BD239C	TO-220		100		200 μA*	100	15 40	1A 4 200 4	0.7	1.3*	1A		3	200	420	6	5/6	4F(2C)
BD240	TO-220		45		200 μA*	45	15 40	1A 4 200 4	0.7	1.3*	1A		3	200	420	6	5/6	5F(3C)
BD240A	TO-220		60		200 μA*	60	15 40	1A 4 200 4	0.7	1.3*	1A		3	200	420	6	5/6	5F(3C)
BD240B	TO-220		80		200 μA*	80	15 40	1A 4 200 4	0.7	1.3*	1A		3	200	420	6	5/6	5F(3C)
BD240C	TO-220		100		200 μA*	100	15 40	1A 4 200 4	0.7	1.3*	1A		3	200	420	6	5/6	5F(3C)
BD241	TO-220		45		200 μA*	45	10 25	3A 4 1A 4	1.3	1.8*	3A		3	500	420	6	5/6	4F(2C)
BD241A	TO-220		60		200 μA*	60	10 25	3A 4 1A 4	1.3	1.8*	3A		3	500	420	6	5/6	4F(2C)
BD241B	TO-220		80		200 μA*	80	10 25	3A 4 1A 4	1.3	1.8*	3A		3	500	420	6	5/6	4F(2C)
BD241C	TO-220		100		200 μA*	100	10 25	3A 4 1A 4	1.3	1.8*	3A		3	500	420	6	5/6	4F(2C)
BD242	TO-220		45		200 μA*	45	10 25	3A 4 1A 4	1.2	1.8*	3A		3	500	420	6	5/6	5E(3E)
BD242A	TO-220		60		200 μA*	60	10 25	3A 4 1A 4	1.2	1.8*	3A		3	500	420	6	5/6	5E(3E)



Type No.	Case Style	V <sub>CE</sub> <sup>*</sup> V <sub>CB0</sub> (V) Min	V <sub>CEO</sub> (V) Min	V <sub>EBO</sub> (V) Min	I <sub>CE</sub> <sup>*</sup> I <sub>CB0</sub> (mA) Max	V <sub>CB</sub> (V)	HFE h <sub>FE</sub> @ 1 kHz <sup>*</sup> Min Max	I <sub>C</sub> & V <sub>CE</sub> (mA) (V)	V <sub>CE</sub> (SAT) (V) Max	V <sub>BE</sub> (SAT) & V <sub>BE</sub> (ON) <sup>*</sup> (V) Min Max	I <sub>C</sub> (mA) Max	C <sub>ob</sub> (pF) Max	f <sub>T</sub> (MHz) Min Max	t <sub>off</sub> (ns) Max	NF (dB) Max	Test Condition	Process No.
BD242B	TO-220	80	80		200 μA <sup>*</sup>	80	10 25	3A 1A 4	1.2	1.8 <sup>*</sup>	3A	3	500	420	6	5/6	5E(3E)
BD242C	TO-220	80	100		200 μA <sup>*</sup>	100	10 25	3A 1A 4	1.2	1.8 <sup>*</sup>	3A	3	500	420	6	5/6	5E(3E)
BD370A	TO-92+ (91)	80	45		100	45	25 40	500 400 100 1	0.7	1.2 <sup>*</sup>	1A	30	50	420	6	5/6	78
BD370A-10	TO-92+ (91)	80	45		100	45	25 63	500 160 100 1	0.7	1.2 <sup>*</sup>	1A	30	50	420	6	5/6	78
BD370A-16	TO-92+ (91)	80	45		100	45	25 100	500 250 100 1	0.7	1.2 <sup>*</sup>	1A	30	50	420	6	5/6	78
BD370A-25	TO-92+ (91)	80	45		100	45	160 400	500 100 1	0.7	1.2 <sup>*</sup>	1A	30	50	420	6	5/6	78
BD370B	TO-92+ (91)	80	60		100	60	25 40	500 100 1	0.7	1.2 <sup>*</sup>	1A	30	50	420	6	5/6	78
BD370B-10	TO-92+ (91)	80	60		100	60	25 63	500 160 100 1	0.7	1.2 <sup>*</sup>	1A	30	50	420	6	5/6	78
BD370B-16	TO-92+ (91)	80	60		100	60	25 100	500 250 100 1	0.7	1.2 <sup>*</sup>	1A	30	50	420	6	5/6	78
BD370B-25	TO-92+ (91)	80	60		100	60	25 160	500 400 100 1	0.7	1.2 <sup>*</sup>	1A	30	50	420	6	5/6	78
BD370C	TO-92+ (91)	80	80		100	80	25 40	500 400 100 1	0.7	1.2 <sup>*</sup>	1A	30	50	420	6	5/6	78
BD370-6	TO-92+ (91)	80	80		100	80	25 40	500 100 1	0.7	1.2 <sup>*</sup>	1A	30	50	420	6	5/6	78
BD370C-10	TO-92+ (91)	80	80		100	80	25 63	500 160 100 1	0.7	1.2 <sup>*</sup>	1A	30	50	420	6	5/6	78
BD370C-16	TO-92+ (91)	80	80		100	80	25 100	500 250 100 1	0.7	1.2 <sup>*</sup>	1A	30	50	420	6	5/6	78
BD370D	TO-92+ (91)	80	100		100	80	25 40	500 400 100 1	0.7	1.2 <sup>*</sup>	1A	30	50	420	6	5/6	79
BD370D-6	TO-92+ (91)	80	100		100	80	25 40	500 100 1	0.7	1.2 <sup>*</sup>	1A	30	50	420	6	5/6	79

**TEST CONDITIONS:**

(1) I<sub>C</sub> = 200 μA, V<sub>CE</sub> = 5V, f = 1kHz. (2) I<sub>C</sub> = 100mA, V<sub>CC</sub> = 20V, I<sub>B</sub><sup>1</sup> = I<sub>B</sub><sup>2</sup> = 5mA. (3) I<sub>C</sub> = 200 μA, V<sub>CE</sub> = 2V, f = 1kHz. (4) I<sub>C</sub> = 100mA, V<sub>CC</sub> = 10V, I<sub>B</sub><sup>1</sup> = I<sub>B</sub><sup>2</sup> = 10mA. (5) I<sub>C</sub> = 10mA, V<sub>CC</sub> = 3V, I<sub>B</sub><sup>1</sup> = I<sub>B</sub><sup>2</sup> = 1mA. (6) I<sub>C</sub> = 100 μA, V<sub>CE</sub> = 5V, f = 1kHz. (7) I<sub>C</sub> = 1mA, V<sub>CE</sub> = 10V, f = 200kHz. (8) I<sub>C</sub> = 1mA, V<sub>CE</sub> = 5V, f = 1kHz. (9) I<sub>C</sub> = 150mA, V<sub>CC</sub> = 6V, I<sub>B</sub><sup>1</sup> = I<sub>B</sub><sup>2</sup> = 15mA. (10) I<sub>C</sub> = 200 μA, V<sub>CE</sub> = 5V, f = 1kHz. (11) I<sub>C</sub> = 150mA, V<sub>CC</sub> = 10V, I<sub>B</sub><sup>1</sup> = I<sub>B</sub><sup>2</sup> = 75mA. (12) I<sub>C</sub> = 300mA, V<sub>CC</sub> = 25V, I<sub>B</sub><sup>1</sup> = I<sub>B</sub><sup>2</sup> = 30mA. (13) I<sub>C</sub> = 10 μA, V<sub>CE</sub> = 5V, f = WB. (14) I<sub>C</sub> = 500mA, V<sub>CC</sub> = 25V, I<sub>B</sub><sup>1</sup> = 50mA, I<sub>B</sub><sup>2</sup> = 25mA. (15) I<sub>C</sub> = 10mA, V<sub>BE</sub> = 2V, I<sub>B</sub><sup>1</sup> = 3mA, I<sub>B</sub><sup>2</sup> = 1mA. (16) I<sub>C</sub> = 100mA, I<sub>B</sub><sup>1</sup> = 40mA, I<sub>B</sub><sup>2</sup> = 20mA.



Type No.	Case Style	V <sub>CE</sub> * V <sub>CB0</sub> (V) Min	V <sub>CEO</sub> (V) Min	V <sub>EB0</sub> (V) Min	I <sub>CB0</sub> * I <sub>CB0</sub> (mA) Max	V <sub>CB</sub> (V)	HFE h <sub>fe</sub> @ 1 kHz* Min Max	I <sub>C</sub> & V <sub>CE</sub> (mA) (V) Min Max	V <sub>CE(SAT)</sub> (V) Max	V <sub>BE(SAT)</sub> & V <sub>BE(ON)*</sub> (V) Min Max	I <sub>C</sub> (mA) Min Max	C <sub>ob</sub> (pF) Max	f <sub>T</sub> (MHz) Min Max	I <sub>C</sub> (mA) @ Min Max	t <sub>off</sub> (ns) Max	NF (dB) Max	Test Condition	Process No.
BD370D-10	TO-92+ (91)	80	100		100	80	25 63 160 100	500 2 100 1	0.7	1.2*	1A	30	50	200	420	6	5/6	79
BD371A	TO-92+ (91)	80	45		100	45	25 40 500 400	500 2 100 1	0.7	1.2*	1A	30	50	200	420	6	5/6	38
BD371A-10	TO-92+ (91)	80	45		100	45	25 63 500 160	500 2 100 1	0.7	1.2*	1A	30	50	200	420	6	5/6	38
BD371A-16	TO-92+ (91)	80	45		100	45	25 100 500 250	500 2 100 1	0.7	1.2*	1A	30	50	200	420	6	5/6	38
BD371A-25	TO-92+ (91)	80	45		100	45	25 160 500 400	500 2 100 1	0.7	1.2*	1A	30	50	200	420	6	5/6	38
BD371B	TO-92+ (91)	80	60		100	60	40 25 400 500	500 2 100 1	0.7	1.2*	1A	30	50	200	420	6	5/6	38
BD371B-10	TO-92+ (91)	80	60		100	60	25 63 500 160	500 2 100 1	0.7	1.2*	1A	30	50	200	420	6	5/6	38
BD371B-16	TO-92+ (91)	80	60		100	60	25 100 500 250	500 2 100 1	0.7	1.2*	1A	30	50	200	420	6	5/6	38
BD371B-25	TO-92+ (91)	80	60		100	60	25 160 500 400	500 2 100 1	0.7	1.2*	1A	30	50	200	420	6	5/6	38
BD371C	TO-92+ (91)	80	80		100	80	40 25 400 500	500 2 100 1	0.7	1.2*	1A	30	50	200	420	6	5/6	38
BD371C-6	TO-92+ (91)	80	80		100	80	25 40 500 400	500 2 100 1	0.7	1.2*	1A	30	50	200	420	6	5/6	38
BD371C-10	TO-92+ (91)	80	80		100	80	25 63 500 160	500 2 100 1	0.7	1.2*	1A	30	50	200	420	6	5/6	38
BD371C-16	TO-92+ (91)	80	80		100	80	25 100 500 250	500 2 100 1	0.7	1.2*	1A	30	50	200	420	6	5/6	38
BD371D	TO-92+ (91)	80	100		100	100	25 25 100 500	500 2 100 1	0.7	1.2*	1A	30	50	200	420	6	5/6	39
BD371D-6	TO-92+ (91)	80	100		100	100	25 40 500 400	500 2 100 1	0.7	1.2*	1A	30	50	200	420	6	5/6	39
BD371D-10	TO-92+ (91)	80	100		100	100	25 63 500 160	500 2 100 1	0.7	1.2*	1A	30	50	200	420	6	5/6	39
BD372A	TO-92+ (90)	80	45		100	45	40 25 400 500	500 2 100 1	0.7	1.2*	1A	30	50	200	420	6	5/6	78
BD372A-10	TO-92+ (90)	80	45		100	45	25 63 500 160	500 2 100 1	0.7	1.2*	1A	30	50	200	420	6	5/6	78
BD372A-16	TO-92+ (90)	80	45		100	45	25 100 500 250	500 2 100 1	0.7	1.2*	1A	30	50	200	420	6	5/6	78





Type No.	Case Style	V <sub>CE(S)</sub> V <sub>CB0</sub> (V) Min	V <sub>CEO</sub> (V) Min	V <sub>EB0</sub> (V) Min	I <sub>CB0</sub> <sup>+</sup> (mA) Max	V <sub>CB</sub> (V) @ I <sub>C</sub>	HFE		I <sub>C</sub> & V <sub>CE</sub>		V <sub>CE(SAT)</sub> & V <sub>BE(ON)</sub> <sup>+</sup>		I <sub>C</sub> (mA) @ I <sub>C</sub>	C <sub>ob</sub> (pF) Max	f <sub>T</sub> (MHz) Min	I <sub>C</sub> (mA) @ I <sub>C</sub>	t <sub>off</sub> (ns) Max	NF (dB) Max	Test Condition	Process No.
							h <sub>fe</sub> 1 kHz*	h <sub>fe</sub> 1 kHz*	I <sub>C</sub> (mA) @ I <sub>C</sub>	V <sub>CE</sub> (V) @ I <sub>C</sub>	V <sub>CE(SAT)</sub> (V) Max	V <sub>BE(ON)</sub> <sup>+</sup> (V) Min								
BD372A-25	TO-92+ (90)	80	45	45	100	45	25 160	500 400	2 1	0.7	1.2*	1A	30	50	200	420	6	5/6	78	
BD372B	TO-92 (90)	80	60	60	100	60	25 40	500 400	2 1	0.7	1.2*	1A	30	50	200	420	6	5/6	78	
BD372B-10	TO-92 (90)	80	60	60	100	60	25 63	500 160	2 1	0.7	1.2*	1A	30	50	200	420	6	5/6	78	
BD372B-16	TO-92 (90)	80	60	60	100	60	25 100	500 250	2 1	0.7	1.2*	1A	30	50	200	420	6	5/6	78	
BD372B-25	TO-92 (90)	80	60	60	100	60	25 160	500 400	2 1	0.7	1.2*	1A	30	50	200	420	6	5/6	78	
BD372C	TO-92+ (90)	80	80	80	100	80	25 40	500 400	2 1	0.7	1.2*	1A	30	50	200	420	6	5/6	78	
BD372C-6	TO-92+ (90)	80	80	80	100	80	25 40	500 100	2 1	0.7	1.2*	1A	30	50	200	420	6	5/6	78	
BD372C-10	TO-92+ (90)	80	80	80	100	80	25 63	500 160	2 1	0.7	1.2*	1A	30	50	200	420	6	5/6	78	
BD372C-16	TO-92+ (90)	80	80	80	100	80	25 100	500 250	2 1	0.7	1.2*	1A	30	50	200	420	6	5/6	78	
BD372D	TO-92+ (90)	80	100	100	100	100	25 40	500 400	2 1	0.7	1.2*	1A	30	50	200	420	6	5/6	79	
BD372D-6	TO-92+ (90)	80	100	100	100	100	25 40	500 100	2 1	0.7	1.2*	1A	30	50	200	420	6	5/6	79	
BD372D-10	TO-92+ (90)	80	100	100	100	100	25 63	500 160	2 1	0.7	1.2*	1A	30	50	200	420	6	5/6	79	
BD373A	TO-92+ (90)	80	45	45	100	45	25 40	500 400	2 1	0.7	1.2*	1A	30	50	200	420	6	5/6	38	
BD373A-10	TO-92+ (90)	80	45	45	100	45	25 63	500 160	2 1	0.7	1.2*	1A	30	50	200	420	6	5/6	38	
BD373A-16	TO-92+ (90)	80	45	45	100	45	25 100	500 250	2 1	0.7	1.2*	1A	30	50	200	420	6	5/6	38	
BD373A-25	TO-92+ (90)	80	45	45	100	45	25 160	500 400	2 1	0.7	1.2*	1A	30	50	200	420	6	5/6	38	

**TEST CONDITIONS:**

(1) I<sub>C</sub> = 200 μA, V<sub>CE</sub> = 5V, f = 1kHz. (2) I<sub>C</sub> = 100mA, V<sub>CC</sub> = 20V, I<sub>B</sub><sup>1</sup> = I<sub>B</sub><sup>2</sup> = 5mA. (3) I<sub>C</sub> = 200 μA, V<sub>CE</sub> = 2V, f = 1kHz. (4) I<sub>C</sub> = 100mA, V<sub>CC</sub> = 10V, I<sub>B</sub><sup>1</sup> = I<sub>B</sub><sup>2</sup> = 10mA. (5) I<sub>C</sub> = 10mA, V<sub>CC</sub> = 3V, I<sub>B</sub><sup>1</sup> = I<sub>B</sub><sup>2</sup> = 1mA. (6) I<sub>C</sub> = 100 μA, V<sub>CE</sub> = 5V, f = 1kHz. (7) I<sub>C</sub> = 1mA, V<sub>CE</sub> = 10V, f = 200kHz. (8) I<sub>C</sub> = 1mA, V<sub>CE</sub> = 5V, f = 1kHz. (9) I<sub>C</sub> = 150mA, V<sub>CC</sub> = 6V, I<sub>B</sub><sup>1</sup> = I<sub>B</sub><sup>2</sup> = 15mA. (10) I<sub>C</sub> = 200 μA, V<sub>CE</sub> = 5V, f = 1kHz. (11) I<sub>C</sub> = 150mA, V<sub>CC</sub> = 10V, I<sub>B</sub><sup>1</sup> = I<sub>B</sub><sup>2</sup> = 75mA. (12) I<sub>C</sub> = 300mA, V<sub>CC</sub> = 25V, I<sub>B</sub><sup>1</sup> = I<sub>B</sub><sup>2</sup> = 30mA. (13) I<sub>C</sub> = 10 μA, V<sub>CE</sub> = 5V, f = 500mA. (14) I<sub>C</sub> = 500mA, V<sub>CC</sub> = 25V, I<sub>B</sub><sup>1</sup> = 50mA, I<sub>B</sub><sup>2</sup> = 25mA. (15) I<sub>C</sub> = 10mA, V<sub>BE</sub> = 2V, I<sub>B</sub><sup>1</sup> = 3mA, I<sub>B</sub><sup>2</sup> = 1mA. (16) I<sub>C</sub> = 100mA, I<sub>B</sub><sup>1</sup> = 40mA, I<sub>B</sub><sup>2</sup> = 20mA.



Type No.	Case Style	V <sub>CE(S)</sub> (V) Min	V <sub>CE(O)</sub> (V) Min	V <sub>EB(O)</sub> (V) Min	I <sub>CB(O)</sub> (mA) Max	V <sub>CB</sub> (V)	h <sub>FE</sub> @ 1 kHz*	I <sub>C</sub> & V <sub>CE</sub> (mA) & (V)	V <sub>CE(SATI)</sub> (V) Max	V <sub>BE(SATI)</sub> & V <sub>BE(ON)</sub> * (V) Min Max	I <sub>C</sub> (mA) Max	C <sub>ob</sub> (pF) Max	f <sub>T</sub> (MHz) Min Max	I <sub>C</sub> (mA) Max	t <sub>off</sub> (ns) Max	NF (dB) Max	Test Condition	Process No.
BD373B	TO-92+ (90)	80	60		100	60	25 40	500 2 100 1	0.7	1.2*	1A	30	50	200	420	6	5/6	38
BD373B-10	TO-92+ (90)	80	60		100	60	25 63	500 2 100 1	0.7	1.2*	1A	30	50	200	420	6	5/6	38
BD373B-16	TO-92+ (90)	80	60		100	60	25 100	500 2 100 1	0.7	1.2*	1A	30	50	200	420	6	5/6	38
BD373B-25	TO-92+ (90)	80	60		100	60	25 160	500 2 100 1	0.7	1.2*	1A	30	50	200	420	6	5/6	38
BD373C	TO-92+ (90)	80	80		100	80	40	500 2 100 1	0.7	1.2*	1A	30	50	200	420	6	5/6	38
BD373C-6	TO-92+ (90)	80	80		100	80	25 40	500 2 100 1	0.7	1.2*	1A	30	50	200	420	6	5/6	38
BD373C-10	TO-92+ (90)	80	80		100	80	25 63	500 2 100 1	0.7	1.2*	1A	30	50	200	420	6	5/6	38
BD373C-16	TO-92+ (90)	80	80		100	80	25 100	500 2 100 1	0.7	1.2*	1A	30	50	200	420	6	5/6	38
BD373D	TO-92+ (90)	80	100		100	100	25 40	500 2 100 1	0.7	1.2*	1A	30	50	200	420	6	5/6	39
BD373D-6	TO-92+ (90)	80	100		100	100	25 40	500 2 100 1	0.7	1.2*	1A	30	50	200	420	6	5/6	39
BD373D-10	TO-92+ (90)	80	100		100	100	25 63	500 2 100 1	0.7	1.2*	1A	30	50	200	420	6	5/6	39
BD375	TO-126	50	45		2 μA	45	20	1A 2 375 150 2	1.0	1.5*	1A	30	50	200	420	6	5/6	38
BD375-6	TO-126	50	45		2 μA	45	20	1A 2 100 150 2	1.0	1.5*	1A	30	50	200	420	6	5/6	38
BD375-10	TO-126	50	45		2 μA	45	63	1A 2 160 150 2	1.0	1.5*	1A	30	50	200	420	6	5/6	38
BD375-16	TO-126	50	45		2 μA	45	100	1A 2 250 150 2	1.0	1.5*	1A	30	50	200	420	6	5/6	38
BD375-25	TO-126	50	45		2 μA	45	150	1A 2 375 150 2	1.0	1.5*	1A	30	50	200	420	6	5/6	38
BD376	TO-126	50	45		2 μA	45	40	1A 2 375 150 2	1.0	1.5*	1A	30	50	200	420	6	5/6	78
BD376-6	TO-126	50	45		2 μA	45	20	1A 2 100 150 2	1.0	1.5*	1A	30	50	200	420	6	5/6	78
BD376-10	TO-126	50	45		2 μA	45	63	1A 2 160 150 2	1.0	1.5*	1A	30	50	200	420	6	5/6	78



Type No.	Case Style	V <sub>CE5</sub> <sup>*</sup> V <sub>CE0</sub> (V) Min	V <sub>BE0</sub> (V) Min	I <sub>CE5</sub> <sup>*</sup> I <sub>CE0</sub> (mA) Max	V <sub>CEB</sub> (V)	HFE <sup>hfe</sup> @ 1 kHz Min	HFE <sup>hfe</sup> @ 1 kHz Max	V <sub>CE(SAT)</sub> (V) Max	V <sub>BE(SAT)</sub> (V) Min	I <sub>C</sub> (mA) Max	C <sub>ob</sub> (pF) Max	f <sub>T</sub> (MHz) Min	f <sub>T</sub> (MHz) Max	I <sub>C</sub> (mA) Max	t <sub>off</sub> (ns) Max	NF (dB) Max	Test Condition	Process No.
BD376-16	TO-126	45		2 μA	45	20	200	1.0	1.5*	1A	30	50	200	200	420	6	5/6	78
BD376-25	TO-126	45		2 μA	45	20	375	1.0	1.5*	1A	30	50	200	200	420	6	5/6	78
BD377	TO-126	60		2 μA	60	20	375	1.0	1.5*	1A	30	50	200	200	420	6	5/6	38
BD377-6	TO-126	60		2 μA	60	20	100	1.0	1.5*	1A	30	50	200	200	420	6	5/6	38
BD377-10	TO-126	60		2 μA	60	20	160	1.0	1.5*	1A	30	50	200	200	420	6	5/6	38
BD377-16	TO-126	60		2 μA	60	20	250	1.0	1.5*	1A	30	50	200	200	420	6	5/6	38
BD377-25	TO-126	60		2 μA	60	20	375	1.0	1.5*	1A	30	50	200	200	420	6	5/6	38
BD378	TO-126	60		2 μA	60	20	375	1.0	1.5*	1A	30	50	200	200	420	6	5/6	78
BD378-6	TO-126	60		2 μA	60	20	100	1.0	1.5*	1A	30	50	200	200	420	6	5/6	78
BD378-10	TO-126	60		2 μA	60	20	160	1.0	1.5*	1A	30	50	200	200	420	6	5/6	78
BD378-16	TO-126	60		2 μA	60	20	250	1.0	1.5*	1A	30	50	200	200	420	6	5/6	78
BD378-25	TO-126	60		2 μA	60	20	375	1.0	1.5*	1A	30	50	200	200	420	6	5/6	78
BD379	TO-126	80		2 μA	80	20	375	1.0	1.5*	1A	30	50	200	200	420	6	5/6	39
BD379-6	TO-126	80		2 μA	80	20	100	1.0	1.5*	1A	30	50	200	200	420	6	5/6	39
BD379-10	TO-126	80		2 μA	80	20	160	1.0	1.5*	1A	30	50	200	200	420	6	5/6	39
BD379-16	TO-126	80		2 μA	80	20	250	1.0	1.5*	1A	30	50	200	200	420	6	5/6	39

**TEST CONDITIONS:**

(1) I<sub>C</sub> = 100mA, V<sub>CE</sub> = 5V, f = 1kHz. (2) I<sub>C</sub> = 100mA, V<sub>CE</sub> = 20V, I<sub>B</sub><sup>1</sup> = I<sub>B</sub><sup>2</sup> = 5mA. (3) I<sub>C</sub> = 200 μA, V<sub>CE</sub> = 2V, f = 1kHz. (4) I<sub>C</sub> = 100mA, V<sub>CE</sub> = 10V, I<sub>B</sub><sup>1</sup> = I<sub>B</sub><sup>2</sup> = 10mA. (5) I<sub>C</sub> = 10mA, V<sub>CE</sub> = 3V, I<sub>B</sub><sup>1</sup> = I<sub>B</sub><sup>2</sup> = 1mA. (6) I<sub>C</sub> = 100 μA, V<sub>CE</sub> = 5V, f = 1kHz. (7) I<sub>C</sub> = 1mA, V<sub>CE</sub> = 10V, f = 200kHz. (8) I<sub>C</sub> = 1mA, V<sub>CE</sub> = 5V, f = 1kHz. (9) I<sub>C</sub> = 150mA, V<sub>CE</sub> = 6V, I<sub>B</sub><sup>1</sup> = I<sub>B</sub><sup>2</sup> = 15mA. (10) I<sub>C</sub> = 200 μA, V<sub>CE</sub> = 5V, f = 1kHz. (11) I<sub>C</sub> = 150mA, V<sub>CE</sub> = 10V, I<sub>B</sub><sup>1</sup> = I<sub>B</sub><sup>2</sup> = 75mA. (12) I<sub>C</sub> = 300mA, V<sub>CE</sub> = 25V, I<sub>B</sub><sup>1</sup> = I<sub>B</sub><sup>2</sup> = 30mA. (13) I<sub>C</sub> = 10 μA, V<sub>CE</sub> = 5V, f = 500MHz. (14) I<sub>C</sub> = 500mA, V<sub>CE</sub> = 25V, I<sub>B</sub><sup>1</sup> = 50mA, I<sub>B</sub><sup>2</sup> = 25mA. (15) I<sub>C</sub> = 10mA, V<sub>BE</sub> = 2V, I<sub>B</sub><sup>1</sup> = 3mA, I<sub>B</sub><sup>2</sup> = 1mA. (16) I<sub>C</sub> = 100mA, I<sub>B</sub><sup>1</sup> = 40mA, I<sub>B</sub><sup>2</sup> = 20mA.

# Pro Electron Series



Type No.	Case Style	V <sub>CE0</sub> <sup>*</sup> (V) Min	V <sub>CE0</sub> <sup>*</sup> (V) Min	V <sub>EB0</sub> (V) Min	ICES <sup>*</sup> I <sub>CB0</sub> (nA) Max	V <sub>CB</sub> (V) Max	HFE h <sub>fe</sub> 1 kHz* Min	HFE h <sub>fe</sub> 1 kHz* Max	I <sub>C</sub> & V <sub>CE</sub> (mA) & (V) Max	V <sub>CE(SAT)</sub> (V) Max	V <sub>BE(SAT)</sub> & V <sub>BE(ON)</sub> <sup>*</sup> (V) Min	I <sub>C</sub> (mA) Max	C <sub>ob</sub> (pF) Max	f <sub>T</sub> (MHz) Min	f <sub>T</sub> (MHz) Max	I <sub>C</sub> (mA) Max	t <sub>off</sub> (ns) Max	NF (dB) Max	Test Condition	Process No.
BD379-25	TO-126	100	80		2 μA	80	20 150	375 150	2A 150	1.0	1.5*	1A	30	50	200	200	420	6	5/6	39
BD380	TO-126	100	80		2 μA	80	40	375	2A 150	1.0	1.5*	1A	30	50	200	200	420	6	5/6	79
BD380-6	TO-126	100	80		2 μA	80	20 40	100	2A 150	1.0	1.5*	1A	30	50	200	200	420	6	5/6	79
BD380-10	TO-126	100	80		2 μA	80	20 63	160	2A 150	1.0	1.5*	1A	30	50	200	200	420	6	5/6	79
BD380-16	TO-126	100	80		2 μA	80	20 100	250	2A 150	1.0	1.5*	1A	30	50	200	200	420	6	5/6	79
BD380-25	TO-126	100	80		2 μA	80	20 150	375	2A 150	1.0	1.5*	1A	30	50	200	200	420	6	5/6	79
BD433	TO-126	22†	22	5	100 μA	22	50 85	475 500	2A 500	0.5	1.1*	2A		3	250	250	420	6	5/6	2E
BD434	TO-126	22†	22	5	100 μA	22	50 85	475 500	2A 500	0.5	1.1*	2A	30	3	250	250	420	6	5/6	3E
BD435	TO-126	32†	32	5	100 μA	32	50 85	475 500	2A 500	0.5	1.1*	2A	30	3	250	250	420	6	5/6	2E
BD436	TO-126	32†	32	5	100 μA	32	50 85	475 500	2A 500	0.5	1.1*	2A	30	3	250	250	420	6	5/6	3E
BD437	TO-126	45†	45	5	100 μA	45	40 40	236	2A 500	0.6	1.2*	2A	30	3	250	250	420	6	5/6	2E
BD438	TO-126	45†	45	5	100 μA	45	40 40	236	2A 500	0.6	1.2*	2A	30	3	250	250	420	6	5/6	3E
BD439	TO-126	60†	60	5	100 μA	60	25 40	236	2A 500	0.8	1.5*	2A	30	3	250	250	420	6	5/6	2E
BD440	TO-126	60†	60	5	100 μA	60	25 40	236	2A 500	0.8	1.5*	2A	80	3	250	250	420	6	5/6	3E
BD441	TO-126	80†	80	5	100 μA	80	15 40	236	2A 500	0.8	1.5*	2A	30	3	250	250	420	6	5/6	2E



Type No.	Case Style	V <sub>CE</sub> * V <sub>CB0</sub> (V)		V <sub>CEO</sub> (V) Min	V <sub>EBO</sub> (V) Min	I <sub>CE</sub> * I <sub>CB0</sub> (mA)		h <sub>FE</sub> h <sub>FE</sub> @ 1 kHz*		I <sub>C</sub> & V <sub>CE</sub> (V)		V <sub>CE</sub> (SAT) (V) & V <sub>BE</sub> (ON)* (V)		V <sub>BE</sub> (SAT) & V <sub>BE</sub> (ON)* (V) @ I <sub>C</sub> (mA)		C <sub>ob</sub> (pF) Max	f <sub>T</sub> (MHz) Min Max		I <sub>C</sub> (mA) Max	t <sub>off</sub> (ns) Max	NF (dB) Max	Test Condition	Process No.
		Min	Max			Min	Max	Min	Max	Min	Max	Min	Max	Min	Max		Min	Max					
BD442	TO-126	80†		80	5	100 μA	80	15 40	236	2A 500	1 1	0.8	1.5*	2A	30	3	250	420	6	5/6	3E		
BD533	TO-220	80†		45	5	100 μA	45	25 40	500	2A 500	2 2	0.8	1.5*	2A	30	3	250	420	6	5/6	4E		
BD534	TO-220	80†		45	5	100 μA	45	25 40	500	2A 500	2 2	0.8	1.5*	2A	30	3	250	420	6	5/6	5E		
BD535	TO-220	80†		60	5	100 μA	60	25 40	500	2A 500	2 2	0.8	1.5*	2A	30	3	250	420	6	5/6	4E		
BD536	TO-220	80†		60	5	100 μA	60	25 40	500	2A 500	2 2	0.8	1.5*	2A	30	3	250	420	6	5/6	5E		
BD537	TO-220	80†		80	5	100 μA	80	15 40	500	2A 500	2 2	0.8	1.5*	2A	30	3	250	420	6	5/6	4E		
BD538	TO-220	80†		80	5	100 μA	80	15 40	500	2A 500	2 2	0.8	1.5*	2A	30	3	250	420	6	5/6	5E		
BD633	TO-220	45		45	5	200 μA†	45	25 40	25	1A 25	2 2	0.6	1.3*	1A	30	3	250	420	6	5/6	4F		
BD634	TO-220	45		45	5	200 μA†	45	25 40	25	1A 25	2 2	0.6	1.3*	1A	30	3	250	420	6	5/6	5F		
BD635	TO-220	60		60	5	200 μA†	60	25 40	25	1A 25	2 2	0.6	1.3*	1A	30	3	250	420	6	5/6	4F		
BD636	TO-220	60		60	5	200 μA†	60	25 40	25	1A 25	2 2	0.6	1.3*	1A	30	3	250	420	6	5/6	5F		
BD637	TO-220	100		80	5	200 μA†	100	25 40	25	1A 25	2 2	0.6	1.3*	1A	30	3	250	420	6	5/6	4F		
BD638	TO-220	100		80	5	200 μA†	100	25 40	25	1A 25	2 2	0.6	1.3	1A	30	3	250	420	6	5/6	5F		

**TEST CONDITIONS:**

(1) I<sub>C</sub> = 200 μA, V<sub>CE</sub> = 5V, f = 1kHz. (2) I<sub>C</sub> = 100mA, V<sub>CC</sub> = 20V, I<sub>B</sub><sup>1</sup> = I<sub>B</sub><sup>2</sup> = 5mA. (3) I<sub>C</sub> = 200 μA, V<sub>CE</sub> = 2V, f = 1kHz. (4) I<sub>C</sub> = 100mA, V<sub>CC</sub> = 10V, I<sub>B</sub><sup>1</sup> = I<sub>B</sub><sup>2</sup> = 10mA. (5) I<sub>C</sub> = 10mA, V<sub>CC</sub> = 3V, I<sub>B</sub><sup>1</sup> = I<sub>B</sub><sup>2</sup> = 1mA. (6) I<sub>C</sub> = 100 μA, V<sub>CE</sub> = 5V, f = 1kHz. (7) I<sub>C</sub> = 1mA, V<sub>CE</sub> = 10V, f = 200kHz. (8) I<sub>C</sub> = 1mA, V<sub>CE</sub> = 5V, f = 1kHz. (9) I<sub>C</sub> = 150mA, V<sub>CC</sub> = 6V, I<sub>B</sub><sup>1</sup> = I<sub>B</sub><sup>2</sup> = 15mA. (10) I<sub>C</sub> = 200 μA, V<sub>CE</sub> = 5V, f = 1kHz. (11) I<sub>C</sub> = 150mA, V<sub>CC</sub> = 10V, I<sub>B</sub><sup>1</sup> = I<sub>B</sub><sup>2</sup> = 75mA. (12) I<sub>C</sub> = 300mA, V<sub>CC</sub> = 25V, I<sub>B</sub><sup>1</sup> = I<sub>B</sub><sup>2</sup> = 30mA. (13) I<sub>C</sub> = 10 μA, V<sub>CE</sub> = 5V, f = WB. (14) I<sub>C</sub> = 500mA, V<sub>CC</sub> = 25V, I<sub>B</sub><sup>1</sup> = 50mA, I<sub>B</sub><sup>2</sup> = 25mA. (15) I<sub>C</sub> = 10mA, V<sub>BE</sub> = 2V, I<sub>B</sub><sup>1</sup> = 3mA, I<sub>B</sub><sup>2</sup> = 1mA. (16) I<sub>C</sub> = 100mA, I<sub>B</sub><sup>1</sup> = 40mA, I<sub>B</sub><sup>2</sup> = 20mA.



Type No.	Case Style	V <sub>CE</sub> * V <sub>CB0</sub> (V) Min	V <sub>CE0</sub> (V) Min	V <sub>EB0</sub> (V) Min	I <sub>CE</sub> * I <sub>CB0</sub> (mA) Max	V <sub>CB</sub> (V)	HFE h <sub>fe</sub> @ 1 kHz* Min Max	I <sub>C</sub> & V <sub>CE</sub> (mA) (V) Max	V <sub>CE(SAT)</sub> (V) Max	V <sub>BE(SAT)</sub> & V <sub>BE(ON)*</sub> (V) Min Max	I <sub>C</sub> (mA) Max	C <sub>ob</sub> (pF) Max	f <sub>T</sub> (MHz) Min Max	f <sub>T</sub> (MHz) Min Max	t <sub>off</sub> (ns) Max	NF (dB) Max	Test Condition	Process No.
BD675	TO-126		45		200 μA	45	750	1.5A 3	2.5	2.5*	1.5A		1	1	1.5A			2J
BD675A	TO-126		45		200 μA	45	750	2A 3	2.8	2.5*	2A		1	1	1.5A			2J
BD676	TO-126		45		200 μA	45	750	1.5A 3V	2.5	2.5*	1.5A		1	1	1.5A			3J
BD676A	TO-126		45		200 μA	45	750	2A 3V	2.8	2.5*	2A		1	1	1.5A			3J
BD677	TO-126		60		200 μA	60	750	1.5A 3V	2.5	2.5*	1.5A		1	1	1.5A			2J
BD677A	TO-126		60		200 μA	60	750	2A 3V	2.8	2.5*	2A		1	1	1.5A			2J
BD678	TO-126		60		200 μA	60	750	1.5A 3V	2.5	2.5*	1.5A		1	1	1.5A			3J
BD678A	TO-126		60		200 μA	60	750	2A 3V	2.8	2.5*	2A		1	1	1.5A			3J
BD679	TO-126		80		200 μA	80	750	1.5A 3V	2.5	2.5*	1.5A		1	1	1.5A			2J
BD679A	TO-126		80		200 μA	80	750	2A 3V	2.8	2.5*	2A		1	1	1.5A			2J
BD680	TO-126		80		200 μA	80	750	1.5A 3V	2.5	2.5*	1.5A		1	1	1.5A			3J
BD680A	TO-126		80		200 μA	80	750	2A 3V	2.8	2.5*	2A		1	1	1.5A			3J
BD681	TO-126		100		200 μA	100	750	1.5A 3V	2.5	2.5*	1.5A		1	1	1.5A			2J
BD682	TO-126		100		200 μA	100	750	1.5A 3V	2.5	2.5*	1.5A		1	1	1.5A			3J
BD733	TO-220	25	25	5	200 μA†	25	50	2A 1	0.6	1.1*	2A		1	1	1.5A			4F
BD734	TO-220	25	25	5	200 μA†	25	50	2A 1	0.6	1.1*	2A		1	1	1.5A			5E
BD735	TO-220	35	35	5	200 μA†	35	40	2A 1	0.6	1.1*	2A		1	1	1.5A			4F
BD736	TO-220	35	35	5	200 μA†	35	40	2A 4	0.6	1.1*	2A		1	1	1.5A			5E
BD737	TO-220	45	45	5	200 μA†	45	40	2A 1	0.8	1.1*	2A		1	1	1.5A			4F
BD738	TO-220	45	45	5	200 μA†	45	40	2A 4	0.8	1.1*	2A		1	1	1.5A			5E
BF167	TO-72 (28)	40	30	4	100†	30	26	4 10		0.84*	4							45
BF180	TO-72 (25)	30	20	3	100	20	13	2 10										41
BF181	TO-72 (25)	30	20	3	100	20	13	2 10										41
BF182	TO-72 (25)	25	20	3	100	20	10	2 10										41
BF194	TO-92 (78)																	46

Same as BF254, see page 3-27 for explanation



Type No.	Case Style	V <sub>CE30</sub> <sup>*</sup> (V)		V <sub>CEO</sub> (V)		V <sub>EB0</sub> (V)		I <sub>CE30</sub> <sup>*</sup> (mA)		V <sub>CB</sub> (V)		H <sub>FE</sub> h <sub>FE</sub> @ 1 kHz <sup>*</sup>		I <sub>C</sub> & V <sub>CE</sub> (V)		V <sub>CE(SAT)</sub> (V) & V <sub>BE(ON)</sub> <sup>*</sup> (V)		C <sub>ob</sub> (pF)		f <sub>T</sub> (MHz)		t <sub>off</sub> (ns)		NF (dB)		Test Condition	Process No.			
		Min	Max	Min	Max	Min	Max	Min	Max	Min	Max	Min	Max	Min	Max	Min	Max	Min	Max	Min	Max	Min	Max	Min	Max					
BF195	TO-92 (78)	Same as BF255, see below for explanation																												46
BF196	TO-92 (78)	Same as BF198, see below for explanation																												45
BF197	TO-92 (78)	Same as BF195, see below for explanation																												47
BF198	TO-92 (78)	40	30	4	100	40	26	4	10	4	10	0.85*	4															45		
BF199	TO-92 (78)	40	25	4	100	40	38	7	10	7	10											1100 typ	7					47		
BF200	TO-72 (25)	30	20	3	100	40	15	3	10	12	7																	41		
BF233-2	TO-92 (71)	30	30	4	100	10	40	70	1	10	10	0.65	0.74*	1	1.0	150	1											49		
BF233-3	TO-92 (71)	30	30	4	100	10	60	100	1	10	10	0.65	0.74*	1	1.0	150	1											49		
BF233-4	TO-92 (71)	30	30	4	100	10	90	150	1	10	10	0.65	0.74*	1	1.0	150	1											49		
BF233-5	TO-92 (71)	30	30	4	100	10	140	220	1	10	10	0.65	0.74*	1	1.0	150	1											49		
BF240	TO-92 (78)	40	40	4	100	20	67	222	1	10	10	0.65	0.74*	1	0.34	3.5	7											47		
BF241	TO-92 (78)	40	40	4	100	20	36	125	1	10	10	0.65	0.74*	1	0.34	3.5	7											47		
BF254	TO-92 (78)	30	20	5	100	20	67	220	1	10	10	0.65	0.74*	1	0.34	3.5	7											46		
BF255	TO-92 (78)	30	20	5	100	20	35	125	1	10	10	0.65	0.74*	1	0.34	3.5	7											46		
BF257	TO-39	160	160	5	50	100	25	30	10	10	10	0.65	0.74*	30	0.34	3.5	7											48		
BF258	TO-39	250	250	5	50	200	25	30	10	10	10	0.65	0.74*	30	0.34	3.5	7											48		

**TEST CONDITIONS:**

(1) I<sub>C</sub> = 200 μA, V<sub>CE</sub> = 5V, f = 1kHz. (2) I<sub>C</sub> = 100mA, V<sub>CE</sub> = 20V, I<sub>B</sub><sup>1</sup> = I<sub>B</sub><sup>2</sup> = 5mA. (3) I<sub>C</sub> = 200 μA, V<sub>CE</sub> = 2V, f = 1kHz. (4) I<sub>C</sub> = 100mA, V<sub>CE</sub> = 10V, I<sub>B</sub><sup>1</sup> = I<sub>B</sub><sup>2</sup> = 10mA. (5) I<sub>C</sub> = 10mA, V<sub>CE</sub> = 3V, I<sub>B</sub><sup>1</sup> = I<sub>B</sub><sup>2</sup> = 1mA. (6) I<sub>C</sub> = 100 μA, V<sub>CE</sub> = 5V, f = 1kHz. (7) I<sub>C</sub> = 1mA, V<sub>CE</sub> = 10V, f = 200kHz. (8) I<sub>C</sub> = 1mA, V<sub>CE</sub> = 5V, f = 1kHz. (9) I<sub>C</sub> = 150mA, V<sub>CE</sub> = 6V, I<sub>B</sub><sup>1</sup> = I<sub>B</sub><sup>2</sup> = 15mA. (10) I<sub>C</sub> = 200 μA, V<sub>CE</sub> = 5V, f = 1kHz. (11) I<sub>C</sub> = 150mA, V<sub>CE</sub> = 10V, I<sub>B</sub><sup>1</sup> = I<sub>B</sub><sup>2</sup> = 75mA. (12) I<sub>C</sub> = 300mA, V<sub>CE</sub> = 25V, I<sub>B</sub><sup>1</sup> = I<sub>B</sub><sup>2</sup> = 30mA. (13) I<sub>C</sub> = 10 μA, V<sub>CE</sub> = 5V, f = WB. (14) I<sub>C</sub> = 500mA, V<sub>CE</sub> = 25V, I<sub>B</sub><sup>1</sup> = 50mA, I<sub>B</sub><sup>2</sup> = 25mA. (15) I<sub>C</sub> = 10mA, V<sub>BE</sub> = 2V, I<sub>B</sub><sup>1</sup> = 3mA, I<sub>B</sub><sup>2</sup> = 1mA. (16) I<sub>C</sub> = 100mA, I<sub>B</sub><sup>1</sup> = 40mA, I<sub>B</sub><sup>2</sup> = 20mA.



Type No.	Case Style	V <sub>CE</sub> <sup>*</sup>		V <sub>CE0</sub> (V) Min	V <sub>EB0</sub> (V) Min	I <sub>CE</sub> <sup>*</sup>		h <sub>FE</sub> @ 1 kHz <sup>*</sup>	I <sub>C</sub> & V <sub>CE</sub> (V)		V <sub>CE</sub> (SAT) (V) & V <sub>BE</sub> (ON) <sup>*</sup> (V)		I <sub>C</sub> (mA) Min	C <sub>ob</sub> (pF) Max	f <sub>T</sub> (MHz)		t <sub>off</sub> (ns) Max	NF (dB) Max	Test Condition	Process No.
		V <sub>CB0</sub> (V) Min	V <sub>CB0</sub> (V) Max			I <sub>CB0</sub> (mA) Min	I <sub>CB0</sub> (mA) Max		I <sub>C</sub> (mA) Min	I <sub>C</sub> (mA) Max	V <sub>CE</sub> (V) Min	V <sub>CE</sub> (V) Max			V <sub>BE</sub> (V) Min	V <sub>BE</sub> (V) Max				
BF259	TO-39	300	300	300	5	50	250	25	30	10	1.0	0.65	0.74*	0.34	1			3.5	7	48
BF457	TO-126	160	160	160	5	50	100	25	30	10	1.0	0.65	0.74*	0.34	1			3.5	7	48
BF458	TO-126	250	250	250	5	50	200	25	30	10	1.0	0.65	0.74*	0.34	1			3.5	7	48
BF459	TO-126	300	300	300	5	50	250	25	30	10	1.0	0.65	0.74*	0.34	1			3.5	7	48
BFX13	TO-18	20	15	15	5	50	15	10	100	2	0.2	0.78	1	6	150	10		10	8	66
BFX29	TO-5	20	15	15	5	50	50	50	50	10	0.4	1.3	150	12	100	50	150		9	63
BFX30	TO-5	65	65	65	5	50	50	10	150	0.4	0.9	30	12				290		4	63
BFX37	TO-18	60	60	60	6	20*	50	100	50	0.4	0.4	1.0	50	6	40	0.5		3	10	62
BFX65	TO-18	45	45	45	6	10*	40	100	10	5	0.25	0.9	10	6.5				3	10	62
BFX84	TO-39	45	45	45	6	500	100	15	1A	10	0.15	1.2	10	12	50	50	360		9	14
BFX85	TO-39	45	45	45	6	50	80	15	1A	10	0.15	1.2	10	12	50	50	360		9	14
BFX86	TO-39	45	45	45	6	50	30	15	1A	10	0.15	1.2	10	12	50	50	360		9	14





Type No.	Case Style	V <sub>CE</sub> <sup>†</sup> V <sub>CB</sub> <sup>†</sup> (V) Min	V <sub>CE</sub> <sup>†</sup> (V) Min	V <sub>BE</sub> <sup>†</sup> (V) Min	I <sub>CE</sub> <sup>†</sup> I <sub>CB</sub> <sup>†</sup> (mA) Max	V <sub>CB</sub> (V)	H <sub>FE</sub> h <sub>FE</sub> 1 kHz* Min Max	I <sub>C</sub> & V <sub>CE</sub> (mA) & (V) Max	V <sub>CE</sub> (SAT) (V) Max	V <sub>BE</sub> (SAT) & V <sub>BE</sub> (ON) (V) Min Max	I <sub>C</sub> (mA) Max	C <sub>ob</sub> (pF) Max	f <sub>T</sub> (MHz) Min Max	I <sub>C</sub> (mA) Max	t <sub>off</sub> (ns) Max	NF (dB) Max	Test Condition	Process No.
BFX87	TO-5	45	50	6	50	40	25 40 40	500 150 10 10	0.4	1.3 0.9	150 30	12	100	50	150		9	63
BFX88	TO-5	45	40	6	50	30	25 40 40 40	500 150 10 10	0.4	1.3 0.9	150 30	12	100	50	150		9	63
BFY72	TO-5	50	28	5	20 <sup>†</sup>	40	15 45 30 20 15	500 150 10 10 0.1	0.7	1.6 1.2	500 150	8	250	50	170		12	20
BFY76	TO-18	45	45	6	20 <sup>†</sup>	30	140 80 30	1 0.5 0.01	0.35	1 0.5 0.75*	1 0.1	6	12	0.05		4	13	07
BSX21	TO-18	45	80	6	40 μA	120	20	4		0.9*	4		60	4				07
BSX45-6	TO-39	80 <sup>†</sup>	40	7	10 <sup>†</sup>	60	40	100	1.0	2.0	1A	20	60	50	650		11	14
BSX45-10	TO-39	80 <sup>†</sup>	40	7	10 <sup>†</sup>	60	63	160	1.0	2.0	1A	20	60	50	650		11	14
BSX45-16	TO-39	80 <sup>†</sup>	40	7	10 <sup>†</sup>	60	100	250	1.0	2.0	1A	20	60	50	650		11	14
BSX46-6	TO-39	100 <sup>†</sup>	60	7	10 <sup>†</sup>	60	40	100	1.0	2.0	1A	25	60	50	650		11	14
BSX46-10	TO-39	100 <sup>†</sup>	60	7	10 <sup>†</sup>	60	63	160	1.0	2.0	1A	25	60	50	650		11	14
BSX46-16	TO-39	100 <sup>†</sup>	60	7	10 <sup>†</sup>	60	100	250	1.0	2.0	1A	25	60	50	650		11	14
BSX48	TO-18	50	25	5	120	50	17	100	1.5	1.5	500	6	250	30	110		14	20
BSX88	TO-52	40	15	5	25	20	30 15	10 0.5	0.4	0.72 0.8	10	6	300	10	75		15	21

**TEST CONDITIONS:**

(1) I<sub>C</sub> = 200 μA, V<sub>CE</sub> = 5V, f = 1kHz. (2) I<sub>C</sub> = 100mA, V<sub>CC</sub> = 20V, I<sub>B</sub><sup>1</sup> = I<sub>B</sub><sup>2</sup> = 5mA. (3) I<sub>C</sub> = 200 μA, V<sub>CE</sub> = 2V, f = 1kHz. (4) I<sub>C</sub> = 100mA, V<sub>CC</sub> = 10V, I<sub>B</sub><sup>1</sup> = I<sub>B</sub><sup>2</sup> = 10mA. (5) I<sub>C</sub> = 3V, I<sub>B</sub><sup>1</sup> = I<sub>B</sub><sup>2</sup> = 1mA. (6) I<sub>C</sub> = 100 μA, V<sub>CE</sub> = 5V, f = 1kHz. (7) I<sub>C</sub> = 1mA, V<sub>CE</sub> = 10V, f = 200kHz. (8) I<sub>C</sub> = 1mA, V<sub>CE</sub> = 5V, f = 1kHz. (9) I<sub>C</sub> = 150mA, V<sub>CC</sub> = 6V, I<sub>B</sub><sup>1</sup> = I<sub>B</sub><sup>2</sup> = 15mA. (10) I<sub>C</sub> = 200 μA, V<sub>CE</sub> = 5V, f = 1kHz. (11) I<sub>C</sub> = 150mA, V<sub>CC</sub> = 10V, I<sub>B</sub><sup>1</sup> = I<sub>B</sub><sup>2</sup> = 75mA. (12) I<sub>C</sub> = 300mA, V<sub>CC</sub> = 25V, I<sub>B</sub><sup>1</sup> = I<sub>B</sub><sup>2</sup> = 30mA. (13) I<sub>C</sub> = 10 μA, V<sub>CE</sub> = 5V, f = WB. (14) I<sub>C</sub> = 500mA, V<sub>CC</sub> = 25V, I<sub>B</sub><sup>1</sup> = 50mA, I<sub>B</sub><sup>2</sup> = 25mA. (15) I<sub>C</sub> = 10mA, V<sub>BE</sub> = 2V, I<sub>B</sub><sup>1</sup> = 3mA, I<sub>B</sub><sup>2</sup> = 1mA. (16) I<sub>C</sub> = 100mA, I<sub>B</sub><sup>1</sup> = 40mA, I<sub>B</sub><sup>2</sup> = 20mA.



Type No.	Case Style	V <sub>CE</sub> <sup>*</sup>		V <sub>BE</sub> (V) Min	V <sub>CE0</sub> (V) Min	V <sub>EB0</sub> (V) Min	I <sub>CB0</sub> <sup>*</sup> (mA) Max	h <sub>FE</sub>		I <sub>C</sub> & V <sub>CE</sub>		V <sub>CE</sub> (SAT) (V) & V <sub>BE</sub> (ON) <sup>*</sup> (V)		C <sub>ob</sub> (pF) Max	f <sub>T</sub> (MHz)		t <sub>off</sub> (ns) Max	NF (dB) Max	Test Condition	Process No.
		Min	Max					Min	Max	Min	Max	Min	Max		Min	Max				
BSY38	TO-52	20	12	5	20	5	100	15	45	100	1	0.6	1.5	5	200	10	45		16	21
BSY39	TO-52	20	12	5	20	5	100	30	60	10	0.35	0.25	0.7	5	200	10	45		16	21
BSY51	TO-5	60	25	5	30	5	100	40	120	10	0.35	0.25	0.7	9	130	50	45		16	20
BSY52	TO-5	60	25	5	30	5	100	20	70	100	1	1.0	1.3	9	130	50	45		16	20
BSY53	TO-5	75	30	7	60	7	10	100	300	150	10	0.6	1.3	9	150	50	45		16	20
BSY54	TO-5	75	30	7	60	7	10	20	40	500	10	2.0	1.3	9	150	50	45		16	20
BSY95A	TO-52	20	15	5	16	5	50	35	75	10	0.1	0.35	0.67	6	200	10	50		16	21

**TEST CONDITIONS:**

(1) I<sub>C</sub> = 200 μA, V<sub>CE</sub> = 5V, f = 1kHz. (2) I<sub>C</sub> = 100mA, V<sub>CE</sub> = 20V, I<sub>B</sub><sup>1</sup> = I<sub>B</sub><sup>2</sup> = 5mA. (3) I<sub>C</sub> = 200 μA, V<sub>CE</sub> = 2V, f = 1kHz. (4) I<sub>C</sub> = 100mA, V<sub>CE</sub> = 10V, I<sub>B</sub><sup>1</sup> = I<sub>B</sub><sup>2</sup> = 10mA. (5) I<sub>C</sub> = 10mA, V<sub>CE</sub> = 3V, I<sub>B</sub><sup>1</sup> = I<sub>B</sub><sup>2</sup> = 1mA. (6) I<sub>C</sub> = 100 μA, V<sub>CE</sub> = 5V, f = 1kHz. (7) I<sub>C</sub> = 1mA, V<sub>CE</sub> = 10V, f = 200kHz. (8) I<sub>C</sub> = 1mA, V<sub>CE</sub> = 5V, f = 1kHz. (9) I<sub>C</sub> = 150mA, V<sub>CE</sub> = 6V, I<sub>B</sub><sup>1</sup> = I<sub>B</sub><sup>2</sup> = 15mA. (10) I<sub>C</sub> = 200 μA, V<sub>CE</sub> = 5V, f = 1kHz. (11) I<sub>C</sub> = 150mA, V<sub>CE</sub> = 10V, I<sub>B</sub><sup>1</sup> = I<sub>B</sub><sup>2</sup> = 75mA. (12) I<sub>C</sub> = 300mA, V<sub>CE</sub> = 25V, I<sub>B</sub><sup>1</sup> = I<sub>B</sub><sup>2</sup> = 30mA. (13) I<sub>C</sub> = 10 μA, V<sub>CE</sub> = 5V, f = WB. (14) I<sub>C</sub> = 500mA, V<sub>CE</sub> = 25V, I<sub>B</sub><sup>1</sup> = 50mA, I<sub>B</sub><sup>2</sup> = 25mA. (15) I<sub>C</sub> = 10mA, V<sub>BE</sub> = 2V, I<sub>B</sub><sup>1</sup> = 3mA, I<sub>B</sub><sup>2</sup> = 1mA. (16) I<sub>C</sub> = 100mA, I<sub>B</sub><sup>1</sup> = 40mA, I<sub>B</sub><sup>2</sup> = 20mA.



Section 4  
**JEIDA Series**



JEIDA SERIES

Type No.	Case Style	V <sub>CE</sub> <sup>†</sup> V <sub>CB</sub> (V) Min	V <sub>CEO</sub> (V) Min	V <sub>EB</sub> (V) Min	I <sub>CE</sub> <sup>†</sup> I <sub>CB</sub> (mA) Max	V <sub>CB</sub> (V)	HFE h <sub>fe</sub> 1 kHz* Min Max	I <sub>C</sub> & V <sub>CE</sub> (mA) (V)	V <sub>CE</sub> (SAT) (V) Max	V <sub>BE</sub> (SAT) & V <sub>BE</sub> (ON)* (V) Min Max	I <sub>C</sub> (mA) Min Max	C <sub>ob</sub> (pF) Max	f <sub>T</sub> (MHz) Min Max	I <sub>C</sub> (mA) Min Max	t <sub>off</sub> (ns) Max	NF (dB) Max	Test Condition	Process No.
2SA719	TO-92 (74)	30	25	5	100	20	40	500	0.6	1.5	500		200	50				63
2SA738	TO-126	25	25	5	20 μA	25	20	1.5A	1.0	2A								77
2SC313	TO-72 (25)	30	19	2	500	10	35	500	1.0	1.5*	20	2	600	10				42
2SC372	TO-92 (74)	35	30	4	500	18	200	400	0.4	10	10	3.5	80	1				04
2SC380	TO-92 (74)	35	30	4	500	18	40	240	1.3	10	10	3.2	400	1				23
2SC385	TO-92 (74)	30	15	3	500	15	20	8				1.5	600	8				43
2SC387	TO-92 (74)	30	15	3	500	15	20	8	0.6	1.2	10	1.5	650	8				43
2SC388	TO-92 (74)	25	25	3	25	10	20	200	0.2	1.5	15	2	300	12.5				46
2SC394	TO-92 (74)	35	30	4	500	18	40	240				3.5	100	1				23
2SC398	TO-72 (25)	20	20	3	50	10	20	200				0.5	250	4		4.5	1	44
2SC399	TO-72 (25)	20	20	3	50	10	20	200				0.5	250	4		5.0	1	44
2SC454	TO-92 (74)	30	30	5	500	18	100	320	0.5	0.32*	1	3.5				25	2	27
2SC458	TO-92 (74)	30	30	5	500	18	100	500	0.5	0.75*	2	3.5				10	2	27
2SC460	TO-92 (74)	30	30	5	500	18	35	200	1.1	0.75*	2	3.5				6.5	3	27
2SC461	TO-92 (74)	30	30	5	500	18	35	200	1.1	0.75*	2	3.5						27
2SC463	TO-72 (25)	35	35	4	100	10	30	150	0.2	10	10	0.6				4	4	44
2SC464	TO-72 (25)	30	19	2	500	10	20*	1	1.0	20	20	2.0	600	10				42
2SC466	TO-72 (25)	30	19	2	500	10	20*	1	1.0	20	20	2.0	600	10				42
2SC495	TO-126	70	50	5	1 μA	30	40	240	0.8	1.1*	500	10	50	10				14
2SC535	TO-92 (74)	30	20	4	500	10	35	200				1.2	450	1		5.5	5	42
2SC536	TO-92 (74)	40	30	5	1 μA	35	60	960										04



JEIDA SERIES (Continued)

Type No.	Case Style	V <sub>CE</sub> <sup>*</sup>		V <sub>CEO</sub> (V) Min	V <sub>BO</sub>		I <sub>CS</sub> <sup>*</sup> I <sub>CBO</sub> @ (mA) Max	h <sub>FE</sub> h <sub>FE</sub> @ 1 kHz <sup>*</sup> Min Max		I <sub>C</sub> & V <sub>CE</sub> (mA) (V)	V <sub>CE(SAT)</sub> & V <sub>BE(ON)</sub> <sup>*</sup> (V) (V) Min Max		I <sub>C</sub> (mA) Min Max	C <sub>ob</sub> (pF) Max	f <sub>T</sub> (MHz) Min Max	t <sub>off</sub> (ns) Max	NF (dB) Max	Test Condition	Process No.	
		V <sub>CE</sub> <sup>*</sup> (V) Min	V <sub>CB0</sub> (V) Min		V <sub>BO</sub> (V) Min	V <sub>CB</sub> (V) Max		I <sub>C</sub> (mA) Max	V <sub>CE(SAT)</sub> (V) Max		V <sub>BE(ON)</sub> <sup>*</sup> (V) Min	I <sub>C</sub> (mA) Max								
2SC562	TO-72 (28)	40	30	4	4	10	10	26	4	10			220	500	4				45	
2SC563	TO-72 (28)	40	25	4	4	40	40	38	7	10			360	820	5				47	
2SC644	TO-92 (74)	30	25	5	5	40	40	90	700	2	5							5	6	04
2SC682	TO-72 (25)	20	20	3	3	100	10	20	200	2	10		400	2						44
2SC683	TO-72 (25)	20	20	3	3	100	10	20	200	2	10		400	2				4	4	44
2SC684	TO-92 (74)	30	19	2	2	100	10	40	10	10			900	10					42	
2SC717	TO-92 (74)	30	19	2	2	500	10	40	1	6			600	10					43	
2SC733	TO-92 (74)	35	30	5	5	100	18	70	700	2	6	0.3	80	1				10	2	04
2SC735	TO-92 (74)	35	30	5	5	100	18	25	400	5									19	
2SC761	TO-72 (25)	30	20	3	3			25	2	10			450	950	2				41	
2SC762	TO-72 (25)	30	20	3	3			22	2	10			450	770	2				41	
2SC784	TO-92 (74)	40	30	4	4	500		18	25	140	1	6						6	5	42
2SC785	TO-92 (74)	40	30	4	4	500	18	25	140	1	6								42	
2SC828	TO-92 (74)	30	25	5	5	1 μA	10	65	700	2	5								04	
2SC829	TO-92 (74)	30	20	5	5	1 μA	10	40	500	1	10								23	
2SC947	TO-72 (25)	25	20	3	3			10	2	10			400	1000	3				41	
2SC1047	TO-92 (74)	30	20	3	3			40	500	1	6		450	1					42	
2SC1117	TO-72 (25)	20	20	3	3			60	320	2	10		600	2				7	4	41

TEST CONDITIONS:

(1) V<sub>AG</sub> = 1.4V, V<sub>CC</sub> = 12V, f = 200MHz. (2) I<sub>C</sub> = 0.1mA, V<sub>CE</sub> = 6V, f = 1kHz. (3) I<sub>C</sub> = 2mA, V<sub>CE</sub> = 6V, f = 1MHz. (4) I<sub>C</sub> = 2mA, V<sub>CC</sub> = 10V, f = 200MHz. (5) I<sub>C</sub> = 1mA, V<sub>CE</sub> = 6V, f = 100MHz.  
 (6) I<sub>C</sub> = 0.2mA, V<sub>CE</sub> = 5V, f = 0.1kHz. (7) I<sub>C</sub> = 1mA, V<sub>CE</sub> = 10V, f = 5MHz.



JEIDA SERIES (Continued)

Type No.	Case Style	V <sub>CE</sub> * V <sub>CB</sub> (V) Min	V <sub>CE</sub> (V) Min	V <sub>EB</sub> (V) Min	I <sub>CB</sub> * (mA) Max	V <sub>CB</sub> (V) Max	h <sub>FE</sub> @ 1kHz* Min Max	I <sub>C</sub> & V <sub>CE</sub> (mA) (V) Min Max	V <sub>CE(SAT)</sub> (V) Max	V <sub>BE(SAT)</sub> & V <sub>BE(ON)*</sub> (V) (V) Min Max	I <sub>C</sub> (mA) Max	C <sub>ob</sub> (pF) Max	f <sub>T</sub> (MHz) Min Max	I <sub>C</sub> (mA) Max	t <sub>off</sub> (ns) Max	NF (dB) Max	Test Condition	Process No.
25C1205	TO-92 (74)	30	30	5	500	18	35 200	2 12	1.1	0.75* 2	1	3.5						27
25C1215	TO-92 (74)	30	20	3	100	10	25	2 10		0.72* 2	2	1.5	650	10				42
25C1306	TO-220	65		4	10 μA	40	30 150	500 10	0.6		1A	30	200	150				35
25C1335*	TO-92 (74)	30	30	5	500	18	160 1200	2 12	0.5	0.75* 2	10	3.5				6	2	04
25C1342	TO-92 (74)	30	20	4	500	10	35 200	1 6	1.2		10	1.5	150	1		8.5	5	23
25C1344	TO-92 (74)	30	30	5	500	18	160 1200	2 12	0.5	0.75* 2	10	3.5				8	2	04
25C1359	TO-92 (74)	30	20	5	100	10	50 220	1 10				1.5	150	1		4	7	23
25C1678	TO-220	65		4	10 μA	30	15 10	500 5 1.5A 5	1.0		500	45	100	100				35
25C1318*	TO-92 (74)	60	50	5	100	20	40 60	500 10 15.0 10	0.6	1.5	500		200	50				62
CS9011	TO-92 (72)		18	3	50	18	29 280	1 5										27
CS9012	TO-92 (72)		25	3			64 202	5 1	1.0		250							60
CS9013	TO-92 (72)		25	3			64 202	5 1	1.0		250							09
CS9014	TO-92 (72)		18	3	50	18	60 1000	1 5	0.5		1							04
CS9015	TO-92 (72)		18	3	50	18	60 1000	1 5	0.5		1							71
CS9016	TO-92 (72)		20	3	50	18	29 146	1 5	3	1	10							44
CS9018	TO-92 (72)		12	2	50	15	29 198	1 5	0.6		10							43

TEST CONDITIONS:

(1) V<sub>AG</sub> = 1.4V, V<sub>CC</sub> = 12V, I = 200MHz. (2) I<sub>C</sub> = 0.1mA, V<sub>CE</sub> = 6V, f = 1kHz. (3) I<sub>C</sub> = 2mA, V<sub>CE</sub> = 6V, f = 1MHz. (4) I<sub>C</sub> = 2mA, V<sub>CC</sub> = 10V, f = 200MHz. (5) I<sub>C</sub> = 1mA, V<sub>CE</sub> = 6V, f = 100MHz. (6) I<sub>C</sub> = 0.2mA, V<sub>CE</sub> = 5V, f = 0.1kHz. (7) I<sub>C</sub> = 1mA, V<sub>CE</sub> = 10V, f = 5MHz.



Section 5

**NA/NB/NR Series**





## NA/NB TRANSISTOR SERIES SELECTION GUIDE

### GENERAL DESCRIPTION

The NA series of transistors are complementary power series which provide minimum collector saturation voltages at low drive conditions and feature matched HFE, guaranteed  $V_{BE}$  (on),  $V_{BE}$  (sat),  $V_{CE}$  (sat), etc, for estimating circuit performance at limit conditions. They are ideal for use with the NB series in complementary audio power amplifier applications. In addition, the collector breakdown voltages range from 20 to 60 Volts, which allows great flexibility in other power applications, such as converters/inverters, servo amplifiers, etc. The NB series of transistors are complementary general-purpose devices which cover a wide range of applications from low-noise equalizer preamplifiers to 1.5 Amp class B drivers. This series provides low leakage, low  $V_{CE}$  (sat), high HFE and three different types of collector breakdown voltages (35, 50 and 65 Volts) for multi-purpose usage and total flexibility.

### NA — APPLICATIONS

- 0.1 to 25 Watts fully complementary audio power amplifiers
- Converters/Inverters
- Power control circuits
- Switching/linear regulators
- High current switching circuits
- Servo amplifiers

### NB — APPLICATIONS

- Low noise equalizer preamplifiers
- Class A general purpose amplifiers
- Class B drivers
- Oscillators
- Control/Switching circuits
- Display/line drivers
- Servo amplifiers

### NA SERIES — — COMPLEMENTARY POWER TRANSISTORS

#### device types and ratings

PART #		AVAILABLE PACKAGES	$V_{CE}$ (max) VOLTS	$I_C$ (max) AMPS	HFE	DESCRIPTION
NPN	PNP					
NA01	NA02	TO-92	20	0.8	Matched	0.8A complementary power transistors
NA11	NA12	TO-92	20	1.0	Matched	1.0A complementary power transistors
NA21	NA22	TO-92, TO-92 PLUS	20	1.5	Matched	1.5A complementary power transistors
NA31	NA32	TO-92 PLUS, TO-202	30	2.0	Matched	2.0A complementary power transistors
NA41	NA42	TO-126, TO-220	30	2.5	Guaranteed min	2.5A complementary power transistors
NA51	NA52	TO-126, TO-220	45	3.5	Guaranteed min	3.5A complementary power transistors
NA61	NA62	TO-126, TO-220	45	4.5	Guaranteed min	4.5A complementary power transistors
NA71	NA72	TO-126, TO-220	60	3.5	Guaranteed min	3.5A complementary power transistors

### NB SERIES — — GENERAL PURPOSE COMPLEMENTARY TRANSISTORS

#### device types and ratings

PART #		AVAILABLE PACKAGES	$V_{CE}$ (max) VOLTS	$I_C$ (max) AMPS	$V_{CE}$ (sat)		DESCRIPTION
NPN	PNP				max	$I_C$ /lb (mA)	
NB011	NB021	TO-92	35	0.03	0.3	10/0.5	30mA general purpose transistors
NB012	NB022	TO-92	50	0.03	0.3	10/0.5	30mA general purpose transistors
NB013	NB023	TO-92	35	0.03	0.3	10/0.5	30mA low noise transistors
NB014	NB024	TO-92	50	0.03	0.3	10/0.5	30mA low noise transistors
NB111	NB121	TO-92	35	0.1	0.3	40/0.8	100mA general purpose transistors
NB112	NB122	TO-92	50	0.1	0.3	40/0.8	100mA general purpose transistors
NB113	NB123	TO-92	65	0.1	0.3	40/0.8	100mA general purpose transistors
NB211	NB221	TO-92, TO-92 PLUS	35	0.5	0.4	100/2	500mA medium current drivers
NB212	NB222	TO-92, TO-92 PLUS	50	0.5	0.4	100/2	500mA medium current drivers
NB213	NB223	TO-92, TO-92 PLUS	65	0.5	0.4	100/2	500mA medium current drivers
NB311	NB321	TO-92, TO-92 PLUS, TO-202	35	1.5	0.5	300/10	1.5A complementary power drivers
NB312	NB322	TO-92, TO-92 PLUS, TO-202	50	1.5	0.5	300/10	1.5A complementary power drivers
NB313	NB323	TO-92, TO-92 PLUS, TO-202	65	1.5	0.5	300/10	1.5A complementary power drivers



## COMPLEMENTARY AUDIO AMPLIFIER CROSS REFERENCE CHARTS

### AUDIO OUTPUT POWER -- Battery operated "OTL" amplifiers

OPERATING CONDITIONS	(1) OUTPUT POWER minimum	@ 10% THD typical	RECOMMENDED OUTPUT DEVICES	RECOMMENDED DRIVER DEVICES
6 Volts/8Ω single-bootstrapping 6 Volts/8Ω single-bootstrapping 6 Volts/4Ω single-bootstrapping	380 mW 480 mW 680 mW	380 mW 480 mW 850 mW	NA01 / NA02 NA11 / NA12 NA21 / NA22	NB111 / NB121 NB111 / NB121 NB111 / NB121
6 Volts/4Ω double-bootstrapping 9 Volts/8Ω single-bootstrapping 9 Volts/4Ω single-bootstrapping	920 mW 800 mW 1.4 W	1.0 W 1.0 W 1.8 W	NA21 / NA22 NA21 / NA22 NA21 / NA22	NB111 / NB121 NB111 / NB121 NB111 / NB121
9 Volts/4Ω double-bootstrapping 14 Volts/8Ω single-bootstrapping 14 Volts/4Ω single-bootstrapping	1.9 W 2.0 W 3.8 W	2.2 W 2.3 W 4.2 W	NA21 / NA22 NA21 / NA22 NA31 / NA32	NB111 / NB121 NB111 / NB121 NB211 / NB221

### AUDIO OUTPUT POWER -- AC operated "OTL" amplifiers

OUTPUT POWER (min) @ 10% THD	LOAD IMPEDENCE	(2) REQUIRED SUPPLY VOLTAGE (min)	RECOMMENDED OUTPUT DEVICES	RECOMMENDED DRIVER DEVICES
3 Watts 4 Watts 6 Watts	8Ω 8Ω 8Ω	15 17 20	NA31 / NA32 NA31 / NA32 NA41 / NA42	NB211 / NB221 NB211 / NB221 NB211 / NB221
8 Watts 12 Watts 15 Watts	8Ω 8Ω 8Ω	23 27 32	NA51 / NA52 NA51 / NA52 NA71 / NA72	NB212 / NB222 NB312 / NB322 NB312 / NB322
18 Watts 24 Watts	8Ω 8Ω	35 40	NA71 / NA72 NA71 / NA72	NB313 / NB323 NB313 / NB323
3 Watts 4 Watts 6 Watts	4Ω 4Ω 4Ω	11 13 16	NA31 / NA32 NA31 / NA32 NA41 / NA42	NB211 / NB221 NB211 / NB221 NB211 / NB221
8 Watts 12 Watts 15 Watts	4Ω 4Ω 4Ω	18 20 23	NA51 / NA52 NA51 / NA52 NA61 / NA62	NB211 / NB221 NB311 / NB321 NB312 / NB322
18 Watts 24 Watts	4Ω 4Ω	26 30	NA61 / NA62 NA61 / NA62	NB312 / NB322 NB312 / NB322

**NOTES :** (1) Minimum Output Power levels shown are obtained by considering transistor parameter variations only, and do not include external component value tolerances.  
 (2) Voltage drops across emitter ballast resistors of the output devices are not included as part of the minimum required supply voltages; voltages specified are dc and under full load condition.

### PACKAGE OUTLINES

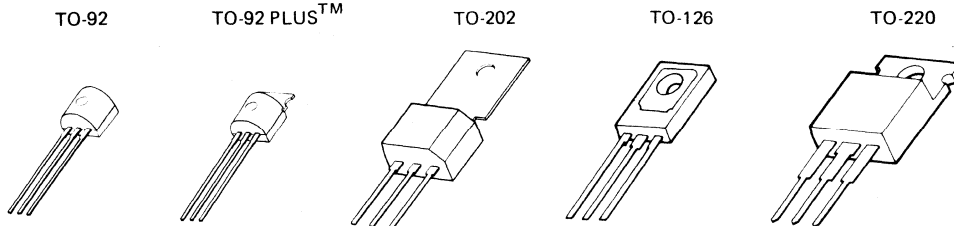

**NAO1(NPN)  
NAO2(PNP) 800mA complementary power transistors**

**features**

- 20 Volt/800 mA Amp rating
- Low  $V_{CE(sat)}$  and  $V_{BE(sat)}$  characteristics at  $I_C = 500\text{ mA}$ ,  $I_B = 50\text{ mA}$
- Guaranteed  $V_{BE(on)}$  characteristics at low current for stable biasing
- Matched HFE groupings for complementary applications
- "Epoxy B" packaging concept for excellent reliability

**1 package and lead coding**

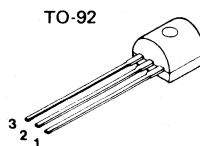

**applications**

- 0.2 to 1 Watt audio power amplifiers
- Medium power switching circuits
- Converter/Inverter circuits
- Circuits for toys

PACKAGE CODE TO-92	LEAD		
	1	2	3
E	E	B	C
F	E	C	B
H	C	B	E

**2 maximum ratings**

PARAMETER	SYMBOL	RATING	UNIT
Collector-Emitter Voltage	$V_{CEO}$	20	$V_{DC}$
Collector-Base Voltage	$V_{CB}$	25	$V_{DC}$
Emitter-Base Voltage	$V_{EB}$	5.0	$V_{DC}$
Collector Current (continuous)	$I_C (max)$	800	mA
Power Dissipation ( $T_A = 25^\circ\text{C}$ ) TO-92	$P_D$	0.6	W
Power Dissipation ( $T_C = 25^\circ\text{C}$ ) TO-92	$P_D$	1.0	W
Thermal Resistance TO-92	$\theta_{JA}$	208	$^\circ\text{C/W}$
	$\theta_{JC}$	125	$^\circ\text{C/W}$
Temperature, Junction and Storage	$T_j, T_{stg}$	-55 to + 150	$^\circ\text{C}$

**3 ordering information**

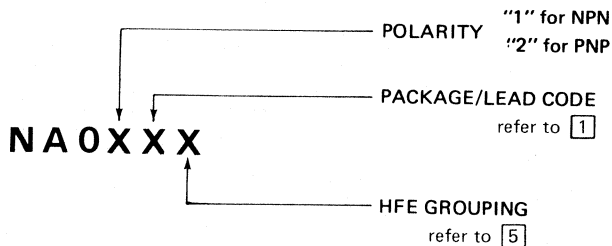

**4** electrical characteristics  $T_C = 25^\circ\text{C}$

SYMBOL	PARAMETER	CONDITIONS	MIN	TYP	MAX	UNIT
$V_{CEO}$	Collector-Emitter Sustaining Voltage	$I_C = 1\text{ mA}$	20			V
$V_{CB0}$	Collector-Base Breakdown Voltage	$I_C = 100\mu\text{A}$	25			V
$V_{EBO}$	Emitter-Base Breakdown Voltage	$I_E = 10\mu\text{A}$	5			V
$I_{CEO}$	Collector-Emitter Leakage Current	$V_{CE} = 15\text{V}$			100	$\mu\text{A}$
$I_{CBO}$	Collector-Base Leakage Current	$V_{CB} = 20\text{V}$			1	$\mu\text{A}$
$V_{BE}(\text{on})$	Base-Emitter Voltage	$I_C = 10\text{ mA}, V_{CE} = 3\text{V}$	630	680	730	mV
$V_{BE}(\text{sat})$	Base-Emitter Saturation Voltage	$I_C = 400\text{ mA}, I_B = 10\text{ mA}$		0.9	1.0	V
$V_{CE}(\text{sat})$	Collector-Emitter Saturation Voltage	$I_C = 400\text{ mA}, I_B = 10\text{ mA}$		0.3	0.5	V
$C_{ob}$	Collector Output Capacitance NPN types PNP types	$V_{CB} = 10\text{V}, f = 1\text{ MHz}$		4.5 7.0		pF pF
$f_t$	Current Gain Bandwidth Product	$I_C = 100\text{ mA}, V_{CE} = 3\text{V}$	50	200		MHz

**5** HFE groupings

GROUPING	PARAMETER	CONDITIONS	MIN	TYP	MAX	RATIO
G	DC Current Gain	$I_C = 100\text{ mA}, V_{CE} = 3\text{V}$	68	85	110	1:1.6
H	DC Current Gain	$I_C = 100\text{ mA}, V_{CE} = 3\text{V}$	100	127	160	1:1.6
I	DC Current Gain	$I_C = 100\text{ mA}, V_{CE} = 3\text{V}$	140	180	240	1:1.6
J	DC Current Gain	$I_C = 100\text{ mA}, V_{CE} = 3\text{V}$	200	260	350	1:1.6
X	DC Current Gain	$I_C = 100\text{ mA}, V_{CE} = 3\text{V}$	30	58	110	1:3.5
Y	DC Current Gain	$I_C = 100\text{ mA}, V_{CE} = 3\text{V}$	100	190	350	1:3.5

**6** physical dimensions

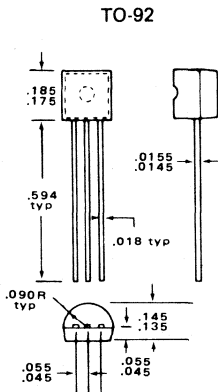

**7** max power dissipation

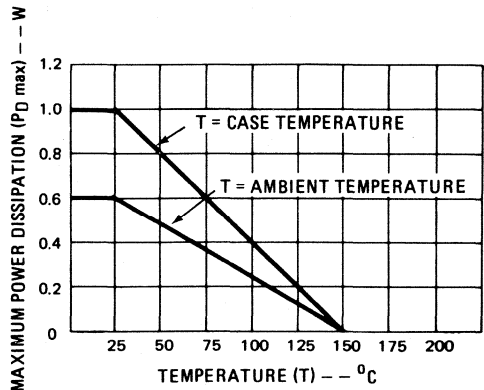

8 typical performance characteristics

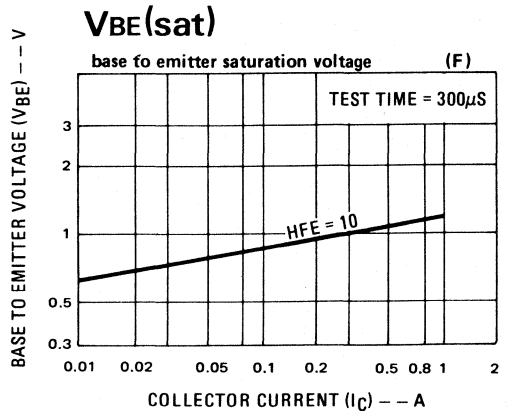
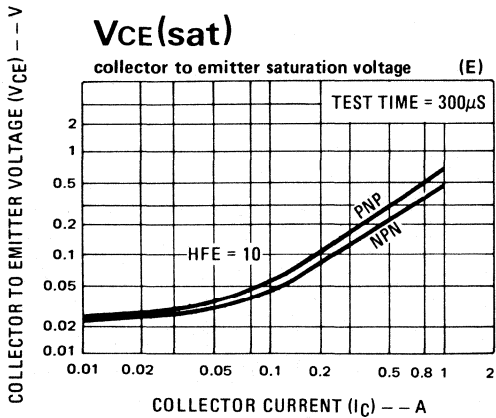
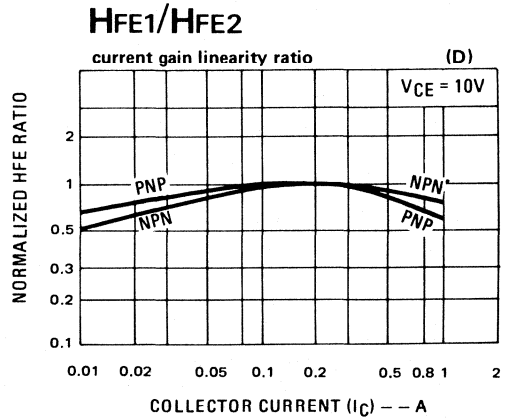
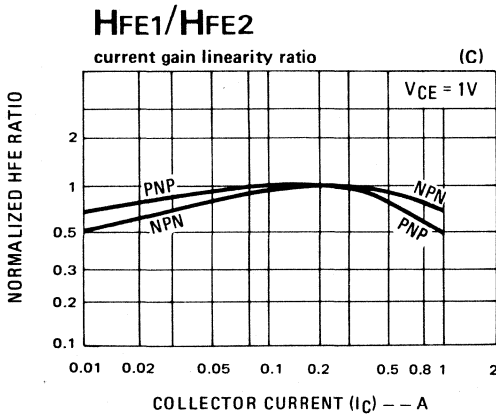
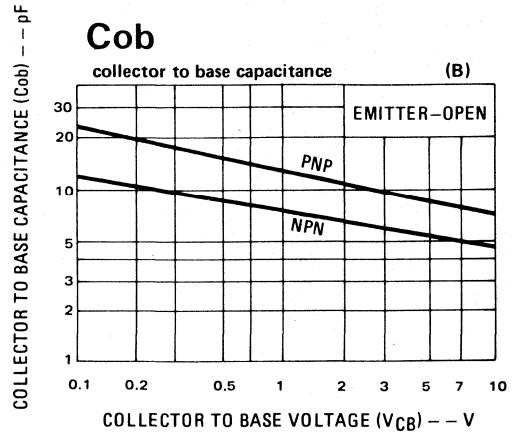
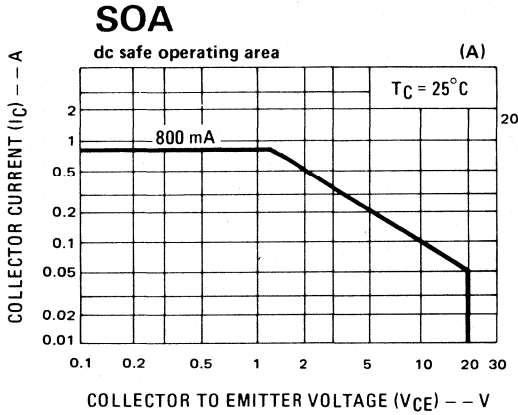

9 typical applications

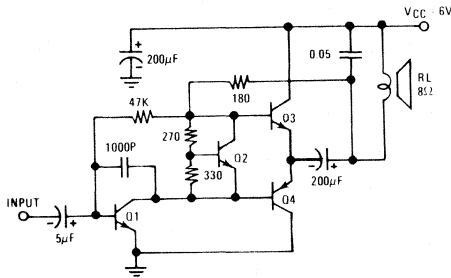

Q1 NB111EH/J Q3 NA01EG/J  
Q2 NR001E Q4 NA01EG/J

Figure A. 380mW 6V/8Ω OTL Amplifier

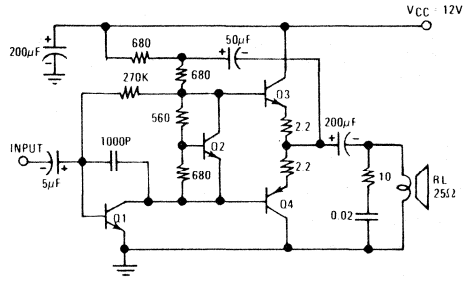

Q1 NB111EH/J Q3 NA01EG/J  
Q2 NR001E Q4 NA01EG/J

Figure B. 650mW 12V/25Ω OTL Amplifier

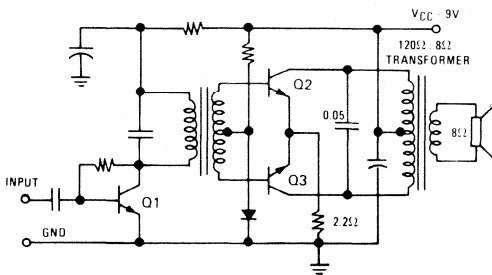

Q1 NB111EH/J Q2 NA01EG/J Q3 NA01EG/J

Figure C. 1.2W Audio Amplifier

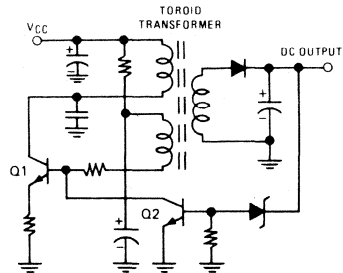

Q1 NA01EX Q2 NB111EY

Figure D. Typical Converter Circuit

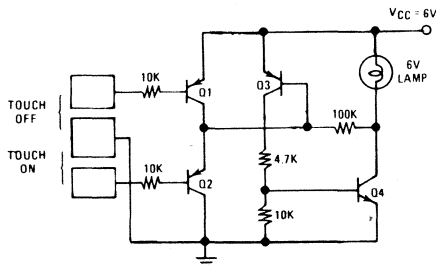

Q1 NB021EY Q3 NB021EY  
Q2 NB021EY Q4 NA01EX

Figure E. Touch-on/Touch-off Electronic Switch

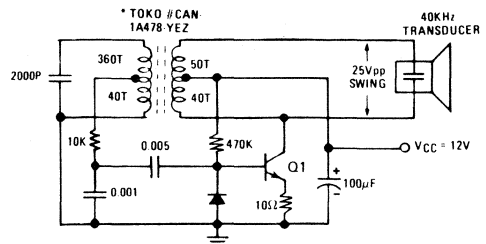

Q1 NA01EX

Figure F. 40KHz Ultrasonic Transmitter



**NA11 (NPN)**  
**NA12 (PNP)** 1 Amp complementary power transistors

**features**

- 20 Volt/1 Amp rating
- Low  $V_{CE}$  (sat) and  $V_{BE}$  (sat) characteristics at  $I_C = 400$  mA,  $I_B = 10$  mA
- Guaranteed  $V_{BE}$  (on) characteristics at low current for stable biasing
- Matched HFE groupings for complementary applications
- "Epoxy B" packaging concept for excellent reliability

**1 package and lead coding**

TO-92

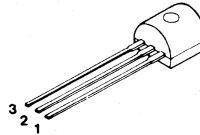

**applications**

- 0.2 to 1 Watt audio power amplifiers
- Medium power switching circuits
- Converter/Inverter circuits
- Circuits for toys

PACKAGE CODE TO-92	LEAD		
	1	2	3
E	E	B	C
F	E	C	B
H	C	B	E

**2 maximum ratings**

PARAMETER	SYMBOL	RATING	UNIT
Collector-Emitter Voltage	$V_{CEO}$	20	$V_{DC}$
Collector-Base Voltage	$V_{CB}$	25	$V_{DC}$
Emitter-Base Voltage	$V_{EB}$	5.0	$V_{DC}$
Collector Current (continuous)	$I_C$ (max)	1.0	A
Power Dissipation ( $T_A = 25^\circ\text{C}$ ) TO-92	$P_D$	0.6	W
Power Dissipation ( $T_C = 25^\circ\text{C}$ ) TO-92	$P_D$	1.0	W
Thermal Resistance TO-92	$\theta_{JA}$	208	$^\circ\text{C/W}$
	$\theta_{JC}$	125	$^\circ\text{C/W}$
Temperature, Junction and Storage	$T_j, T_{stg}$	-55 to +150	$^\circ\text{C}$

**3 ordering information**

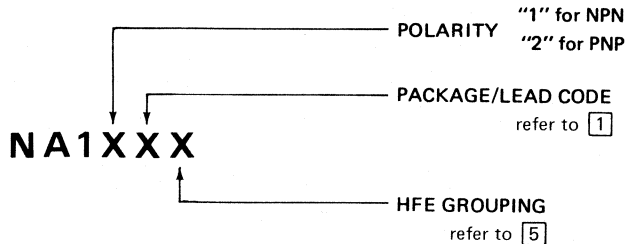

**4** electrical characteristics  $T_C = 25^\circ\text{C}$

SYMBOL	PARAMETER	CONDITIONS	MIN	TYP	MAX	UNIT
$BV_{CEO}$	Collector-Emitter Sustaining Voltage	$I_C = 1 \text{ mA}$	20			V
$BV_{CBO}$	Collector-Base Breakdown Voltage	$I_C = 100\mu\text{A}$	25			V
$BV_{EBO}$	Emitter-Base Breakdown Voltage	$I_E = 10\mu\text{A}$	5			V
$I_{CEO}$	Collector-Emitter Leakage Current	$V_{CE} = 15\text{V}$			100	$\mu\text{A}$
$I_{CBO}$	Collector-Base Leakage Current	$V_{CB} = 20\text{V}$			1	$\mu\text{A}$
$V_{BE}(\text{on})$	Base-Emitter Voltage	$I_C = 10 \text{ mA}, V_{CE} = 3\text{V}$	630	680	730	mV
$V_{BE}(\text{sat})$	Base-Emitter Saturation Voltage	$I_C = 500 \text{ mA}, I_B = 50 \text{ mA}$		0.95	1.5	V
$V_{CE}(\text{sat})$	Collector-Emitter Saturation Voltage	$I_C = 500 \text{ mA}, I_B = 50 \text{ mA}$		0.2	0.5	V
$C_{ob}$	Collector Output Capacitance NPN types PNP types	$V_{CB} = 10\text{V}, f = 1 \text{ MHz}$		4.5 7.0		pF pF
$f_t$	Current Gain Bandwidth Product	$I_C = 100 \text{ mA}, V_{CE} = 3\text{V}$	50	200		MHz

**5** HFE groupings

GROUPING	PARAMETER	CONDITIONS	MIN	TYP	MAX	RATIO
G	DC Current Gain	$I_C = 100 \text{ mA}, V_{CE} = 3\text{V}$	68	85	110	1:1.6
H	DC Current Gain	$I_C = 100 \text{ mA}, V_{CE} = 3\text{V}$	100	127	160	1:1.6
I	DC Current Gain	$I_C = 100 \text{ mA}, V_{CE} = 3\text{V}$	140	180	240	1:1.6
J	DC Current Gain	$I_C = 100 \text{ mA}, V_{CE} = 3\text{V}$	200	260	350	1:1.6
X	DC Current Gain	$I_C = 100 \text{ mA}, V_{CE} = 3\text{V}$	30	58	110	1:3.5
Y	DC Current Gain	$I_C = 100 \text{ mA}, V_{CE} = 3\text{V}$	100	190	350	1:3.5

**6** physical dimensions

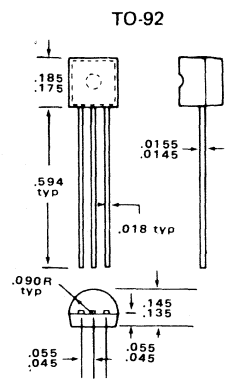

**7** max power dissipation

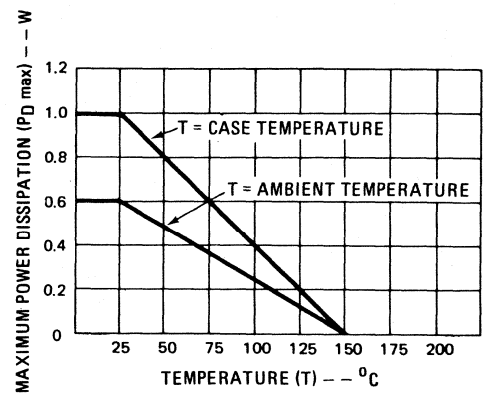

8 typical performance characteristics

SOA

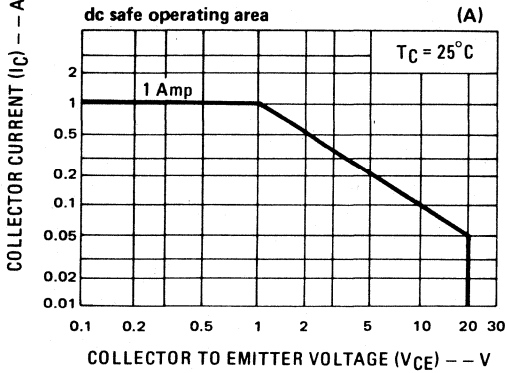

Cob

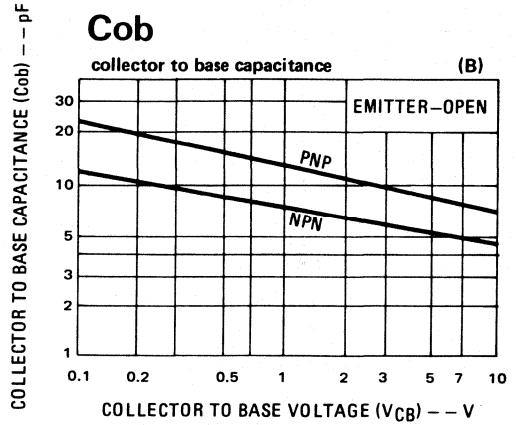

HFE1/HFE2

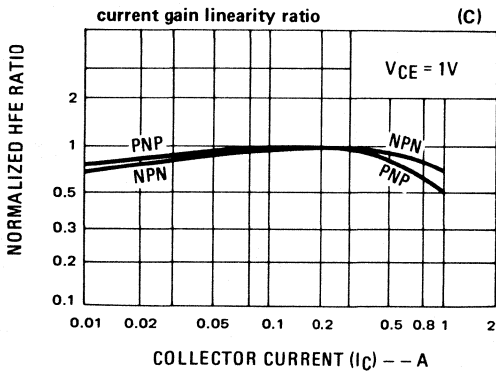

HFE1/HFE2

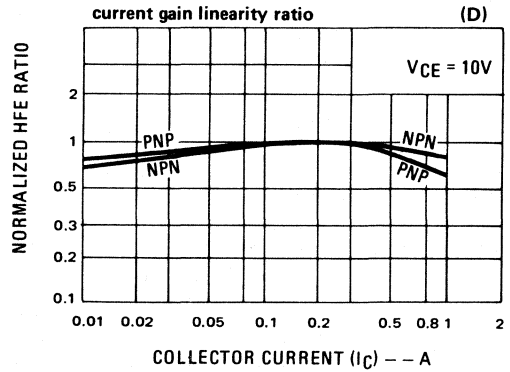

VCE(sat)

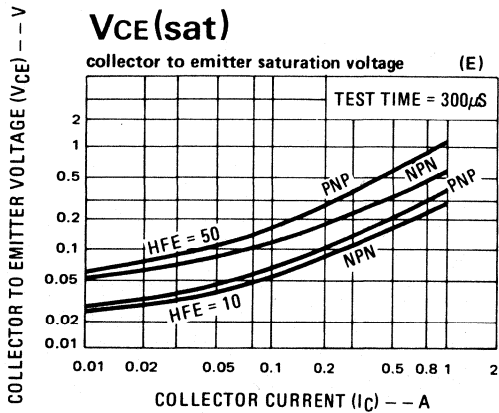

VBE(sat)

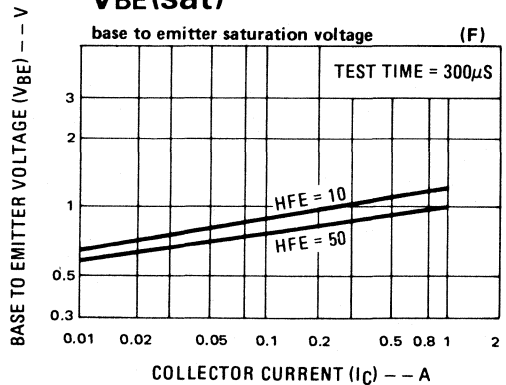



# 9 typical applications

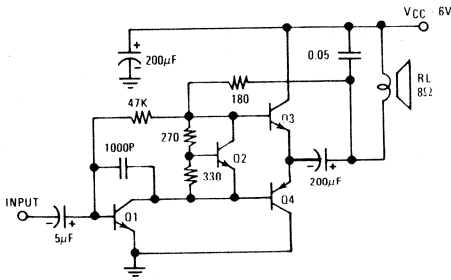

Q1 NB111EH/J      Q3 NA11EG/J  
Q2 NR001E        Q4 NA12EG/J

Figure A. 380mW 6V/8Ω OTL Amplifier

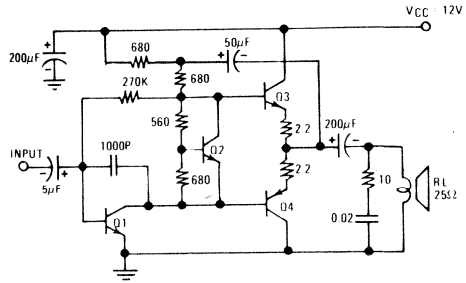

Q1 NB111EH/J      Q3 NA11EG/J  
Q2 NR001E        Q4 NA12EG/J

Figure B. 650mW 12V/25Ω OTL Amplifier

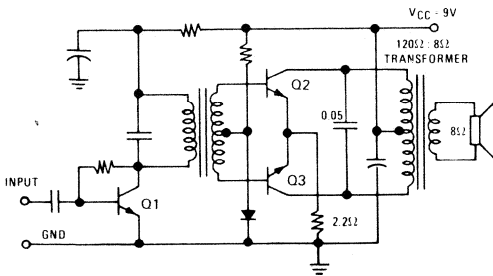

Q1 NB111EH/J    Q2 NA11EG/J    Q3 NA11EG/J

Figure C. 1.2W Audio Amplifier

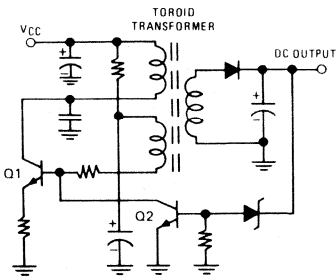

Q1 NA11EX            Q2 NB111EY

Figure D. Typical Converter Circuit

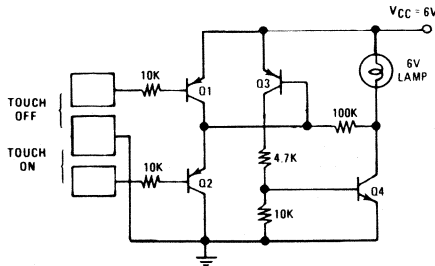

Q1 NB021EY      Q3 NB021EY  
Q2 NB021EY      Q4 NA11EX

Figure E. Touch-on/Touch-off Electronic Switch

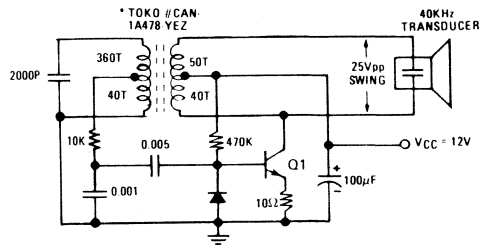

Q1 NA11EX

Figure F. 40KHz Ultrasonic Transmitter



## NA21 (NPN) NA22 (PNP) 1.5 Amp complementary power transistors

### features

- 20 Volt/1.5 Amp rating
- 1.2 Watts practical power dissipation (TO-92 PLUS™)
- Low  $V_{CE}$  (sat) and  $V_{BE}$  (sat) characteristics at  $I_C = 700$  mA,  $I_B = 14$  mA
- Guaranteed  $V_{BE}$  (on) characteristics at small current for stable biasing
- Matched HFE groupings for complementary applications
- "Epoxy B" packaging concept for excellent reliability

### 1 package and lead coding

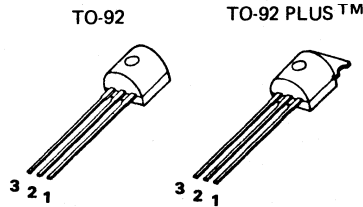

### applications

- 0.5 – 2 Watt audio power amplifiers
- Medium power switching circuits
- Converter/Inverter circuits
- Toy circuits

PACKAGE CODE		LEAD		
TO-92	TO-92 PLUS	1	2	3
E	X	E	B	C
F	Y	E	C	B
	Z	B	C	E
H		C	B	E

### 2 maximum ratings

PARAMETER	SYMBOL	RATING	UNIT
Collector-Emitter Voltage	$V_{CE}$	20	$V_{DC}$
Collector-Base Voltage	$V_{CB}$	25	$V_{DC}$
Emitter-Base Voltage	$V_{EB}$	5.0	$V_{DC}$
Collector Current (continuous)	$I_C$ (max)	1.5	A
Power Dissipation ( $T_A = 25^\circ\text{C}$ )	$P_D$		
TO-92		0.6	W
TO-92 PLUS		0.75	W
Power Dissipation ( $T_C = 25^\circ\text{C}$ )	$P_D$		
TO-92		1.0	W
TO-92 PLUS		2.5	W
Thermal Resistance			
TO-92	$\theta_{JA} / \theta_{JC}$	208/125	$^\circ\text{C/W}$
TO-92 PLUS	$\theta_{JA} / \theta_{JC}$	167/50	$^\circ\text{C/W}$
Temperature, Junction and Storage	$T_j, T_{stg}$	-55 to +150	$^\circ\text{C}$

### 3 ordering information

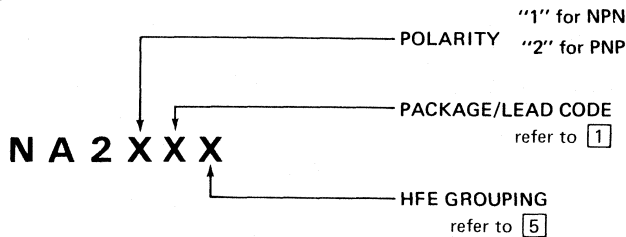

**4** electrical characteristics  $T_C = 25^\circ C$

SYMBOL	PARAMETER	CONDITIONS	MIN	TYP	MAX	UNIT
$BV_{CEO}$	Collector-Emitter Sustaining Voltage	$I_C = 1 \text{ mA}$	20			V
$BV_{CBO}$	Collector-Base Breakdown Voltage	$I_C = 100 \mu A$	25			V
$BV_{EBO}$	Emitter-Base Breakdown Voltage	$I_E = 10 \mu A$	5			V
$I_{CEO}$	Collector-Emitter Leakage Current	$V_{CE} = 15V$			100	$\mu A$
$I_{CBO}$	Collector-Base Leakage Current	$V_{CB} = 20V$			1	$\mu A$
$V_{BE}(\text{on})$	Base-Emitter Voltage	$I_C = 10 \text{ mA}, V_{CE} = 3V$	630	680	730	mV
$V_{BE}(\text{sat})$	Base-Emitter Saturation Voltage	$I_C = 700 \text{ mA}, I_B = 14 \text{ mA}$		0.9	1.0	V
$V_{CE}(\text{sat})$	Collector-Emitter Saturation Voltage	$I_C = 700 \text{ mA}, I_B = 14 \text{ mA}$				
	NPN types			0.35	0.5	V
	PNP types			0.65	1	V
$C_{ob}$	Collector Output Capacitance	$V_{CB} = 10V, f = 1 \text{ MHz}$				
	NPN types			0.45		pF
	PNP types			0.7		pF
$f_t$	Current Gain Bandwidth Product	$I_C = 100 \text{ mA}, V_{CE} = 3V$	50	200		MHz

**5** HFE groupings

GROUPING	PARAMETER	CONDITIONS	MIN	TYP	MAX	RATIO
G	DC Current Gain	$I_C = 100 \text{ mA}, V_{CE} = 3V$	68	85	110	1:1.6
H	DC Current Gain	$I_C = 100 \text{ mA}, V_{CE} = 3V$	100	127	160	1:1.6
I	DC Current Gain	$I_C = 100 \text{ mA}, V_{CE} = 3V$	140	180	240	1:1.6
J	DC Current Gain	$I_C = 100 \text{ mA}, V_{CE} = 3V$	200	260	350	1:1.6
X	DC Current Gain	$I_C = 100 \text{ mA}, V_{CE} = 3V$	30	58	110	1:3.5
Y	DC Current Gain	$I_C = 100 \text{ mA}, V_{CE} = 3V$	100	190	350	1:3.5

**6** physical dimensions

**7** heatsink information

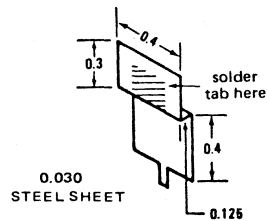
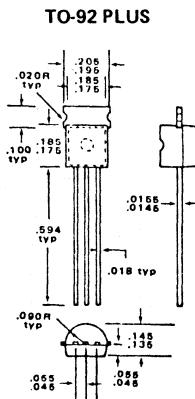
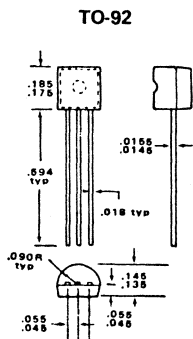

■ TO-92 PLUS package with heatsink shown on right permits 1.6 Watts power dissipation and combined Thermal Resistance  $\theta_{JA} = 78^\circ C/W$ . If used without heatsink and PCB land area at collector lead > 1 sq. inch,  $P_D = 1.2W$ .

8 typical performance characteristics

**SOA**

dc safe operating area

(A)

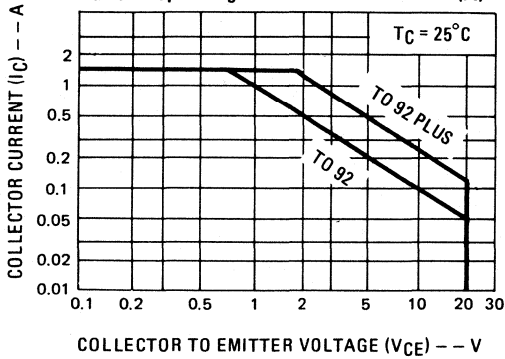

**Cob**

collector to base capacitance

(B)

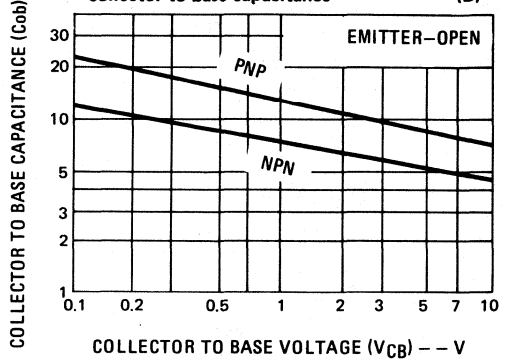

**HFE1/HFE2**

current gain linearity ratio

(C)

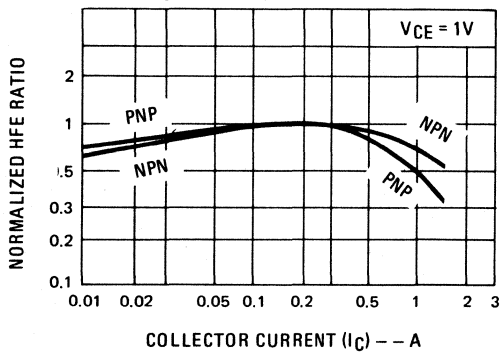

**HFE1/HFE2**

current gain linearity ratio

(D)

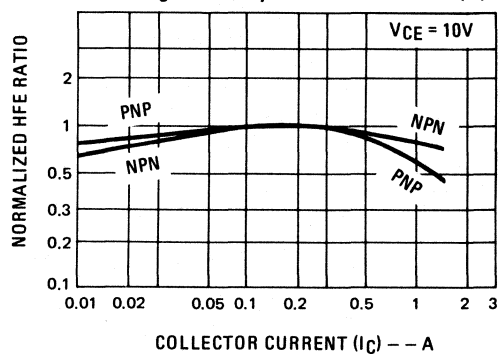

**VCE(sat)**

collector to emitter saturation voltage

(E)

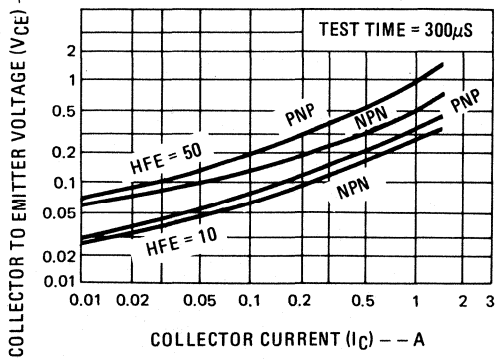

**VBE(sat)**

base to emitter saturation voltage

(F)

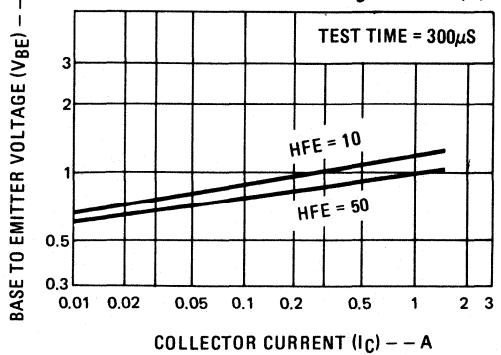

**9** typical applications

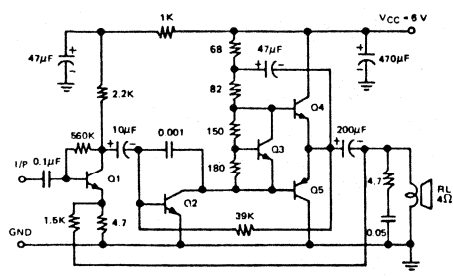

Q1 NB011EY Q3 NR001E Q5 NA22EG/J  
Q2 NB111EH/J Q4 NA21EG/J

**Figure A. 700mW 6V/4Ω OTL Amplifier**

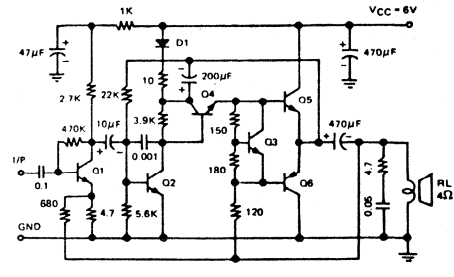

Q1 NB011EY Q3 NR001E Q5 NA21EG/J  
Q2 NB011EY Q4 NB111EY Q6 NA22EG/J

**Figure B. 950mW 6V/4Ω OTL Amplifier**

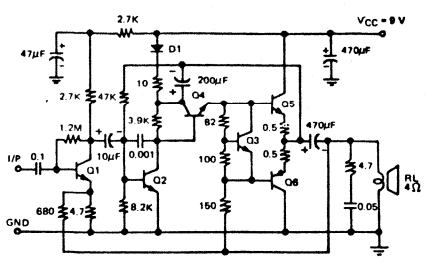

Q1 NB011EY Q3 NR001E Q5 NA21EG/J  
Q2 NB011EY Q4 NB111EY Q6 NA22EG/J

**Figure C. 2W 9V/4Ω OTL Amplifier**

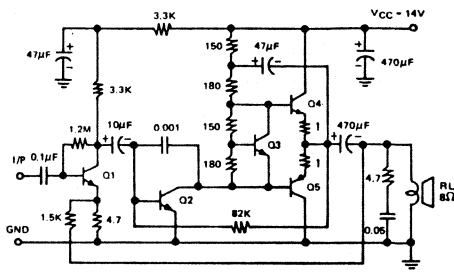

Q1 NB011EY Q3 NR001E Q5 NA22EG/J  
Q2 NB111EH/J Q4 NA21EG/J

**Figure D. 2.2W 14V/8Ω OTL Amplifier**

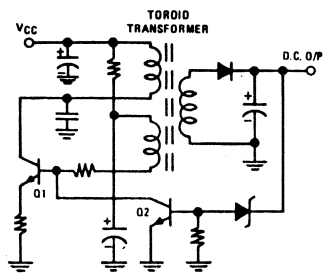

Q1 NA21EX Q2 NB111EY

**Figure E. Typical Converter Circuit**

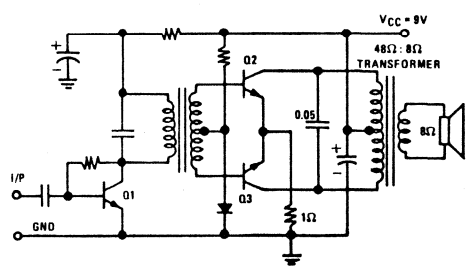

Q1 NB111E Q2 NA21Y G/J Q3 NA21Y G/J

**Figure F. 2W Audio Amplifier**



**NA31 (NPN) 2 Amp complementary power transistors**  
**NA32 (PNP)**

**features**

- 30 Volt/2 Amp rating
- 1.2 Watts practical power dissipation (TO-92 PLUS™)
- 1.75 Watts free air power dissipation (TO-202)
- Low  $V_{CE(sat)}$  and  $V_{BE(sat)}$  characteristics at  $I_C = 1.2A$ ,  $I_B = 30 mA$
- Matched HFE groupings for complementary applications
- "Epoxy B" packaging concept for excellent reliability

**1 packages and lead coding**

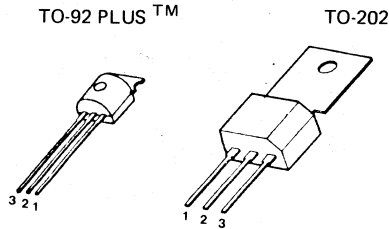

**applications**

- 4-Watt audio power amplifiers
- Medium power switching circuits
- Converter/Inverter circuits
- TV receivers

PACKAGE CODE		LEAD		
TO-92 PLUS	TO-202	1	2	3
X	K	E	B	C
Y	L	E	C	B
Z	M	B	C	E

**2 maximum ratings**

PARAMETER	SYMBOL	RATING	UNIT
Collector-Emitter Voltage	$V_{CEO}$	30	$V_{DC}$
Collector-Base Voltage	$V_{CB}$	35	$V_{DC}$
Emitter-Base Voltage	$V_{EB}$	5.0	$V_{DC}$
Collector Current (continuous)	$I_C (max)$	2.0	A
Power Dissipation ( $T_A = 25^\circ C$ )	$P_D$		
TO-92 PLUS		0.75	W
TO-202		1.75	W
Power Dissipation ( $T_C = 25^\circ C$ )	$P_D$		
TO-92 PLUS		2.5	W
TO-202		10	W
Thermal Resistance			
TO-92 PLUS	$\theta_{JA}/\theta_{JC}$	167/ 50	$^\circ C/W$
TO-202	$\theta_{JA}/\theta_{JC}$	72/ 12.5	$^\circ C/W$
Temperature, Junction and Storage	$T_j, T_{stg}$	-55 to + 150	$^\circ C$

**3 ordering information**

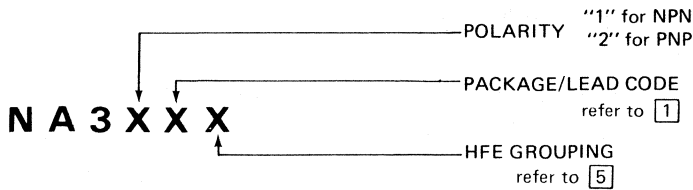

**4 electrical characteristics**  $T_C = 25^\circ C$

SYMBOL	PARAMETER	CONDITIONS	MIN	TYP	MAX	UNIT
$BV_{CEO}$	Collector-Emitter Sustaining Voltage	$I_C = 1 \text{ mA}$	30			V
$BV_{CBO}$	Collector-Base Breakdown Voltage	$I_C = 100 \mu\text{A}$	35			V
$BV_{EBO}$	Emitter-Base Breakdown Voltage	$I_E = 10 \mu\text{A}$	5			V
$I_{CEO}$	Collector-Emitter Leakage Current	$V_{CE} = 25\text{V}$			100	$\mu\text{A}$
$I_{CBO}$	Collector-Base Leakage Current	$V_{CB} = 30\text{V}$			1	$\mu\text{A}$
$V_{BE(on)}$	Base-Emitter Voltage	$I_C = 15 \text{ mA}, V_{CE} = 5\text{V}$	600	650	700	mV
$V_{BE(sat)}$	Base-Emitter Saturation Voltage	$I_C = 1.2\text{A}, I_B = 30 \text{ mA}$		0.95	1.2	V
$V_{CE(sat)}$	Collector-Emitter Saturation Voltage	$I_C = 1.2\text{A}, I_B = 30 \text{ mA}$		0.5	1	V
$V_{BE(sat)}$	Base-Emitter Saturation Voltage	$I_C = 1.2\text{A}, I_B = 120 \text{ mA}$		1.0	1.4	V
$V_{CE(sat)}$	Collector-Emitter Saturation Voltage	$I_C = 1.2\text{A}, I_B = 120 \text{ mA}$		0.25	0.5	V
$C_{ob}$	Collector Output Capacitance NPN types PNP types	$V_{CB} = 10\text{V}, f = 1 \text{ MHz}$		10 17		pF pF
$f_t$	Current Gain Bandwidth Product	$I_C = 300 \text{ mA}, V_{CE} = 5\text{V}$	20			MHz

**5 HFE groupings**

GROUPING	PARAMETER	CONDITIONS	MIN	TYP	MAX	RATIO
G	DC Current Gain	$I_C = 300 \text{ mA}, V_{CE} = 5\text{V}$	68	85	110	1:1.6
H	DC Current Gain	$I_C = 300 \text{ mA}, V_{CE} = 5\text{V}$	100	127	160	1:1.6
I	DC Current Gain	$I_C = 300 \text{ mA}, V_{CE} = 5\text{V}$	140	180	240	1:1.6
J	DC Current Gain	$I_C = 300 \text{ mA}, V_{CE} = 5\text{V}$	200	260	350	1:1.6
X	DC Current Gain	$I_C = 300 \text{ mA}, V_{CE} = 5\text{V}$	30	58	110	1:3.5
Y	DC Current Gain	$I_C = 300 \text{ mA}, V_{CE} = 5\text{V}$	100	190	350	1:3.5

**6 physical dimensions**

**7 heatsink information**

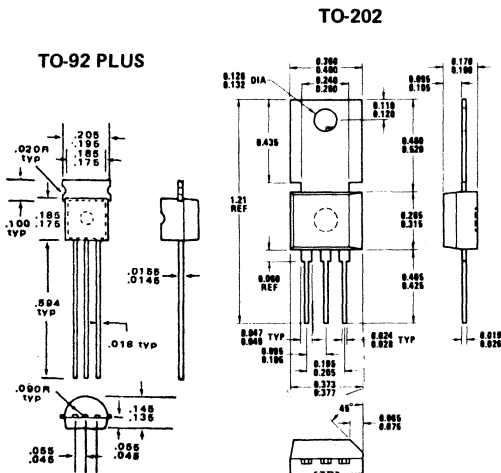

■ TO-92 PLUS package with heatsink shown on right permits 1.6 Watts power dissipation and combined Thermal Resistance  $\theta_{JA} = 78^\circ C/W$ . If used without heatsink and PCB land area at collector lead  $> 1 \text{ sq. inch}$ ,  $P_D = 1.2\text{W}$ .

■ TO-202 package with heatsink shown on right permits 3 Watts  $P_D$  and  $\theta_{JA} = 42^\circ C/W$ .

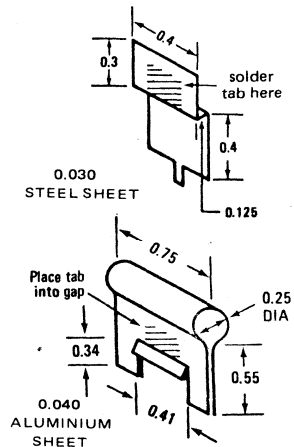

8 typical performance characteristics

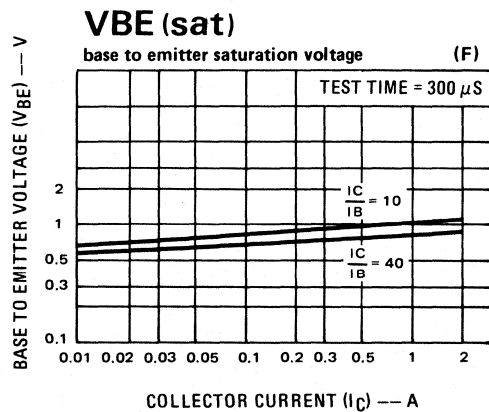
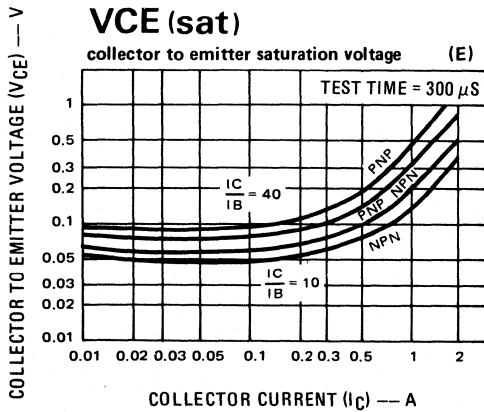
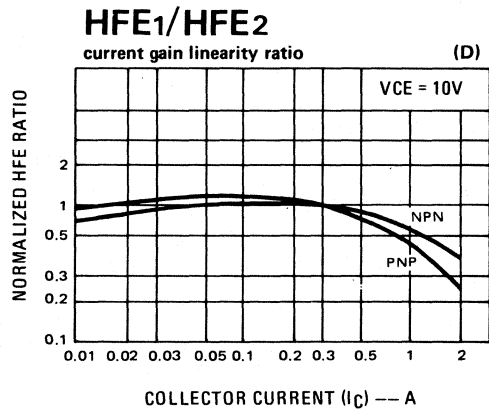
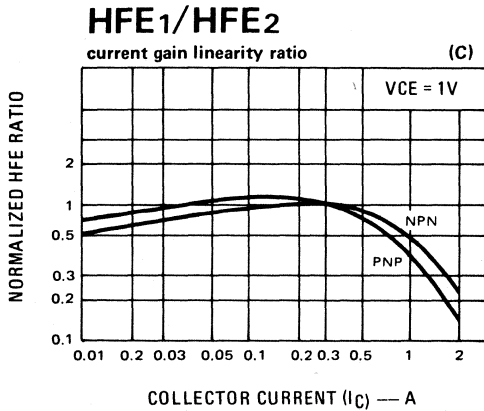
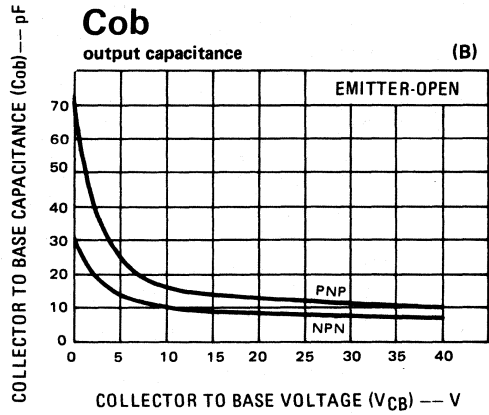
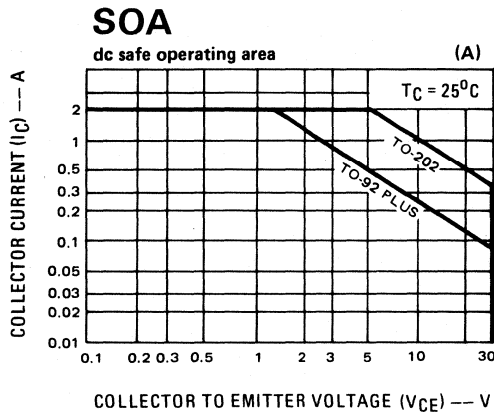



9 typical applications

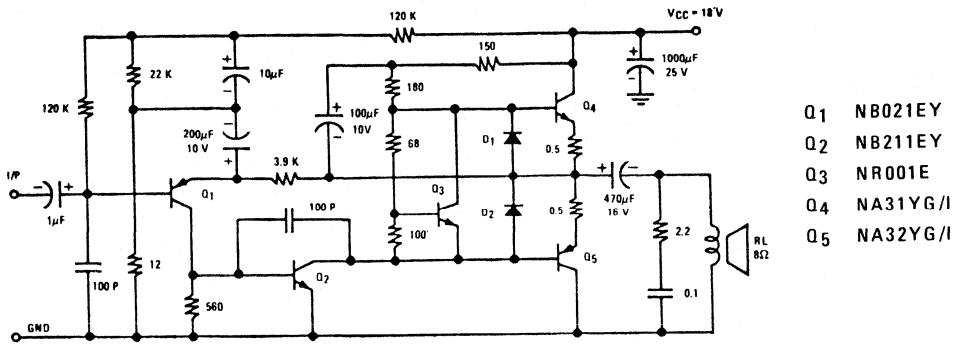

Figure A. 4 Watt / 8 Ohm OTL Amplifier

- Q1 NB021EY
- Q2 NB211EY
- Q3 NR001E
- Q4 NA31YG/I
- Q5 NA32YG/I

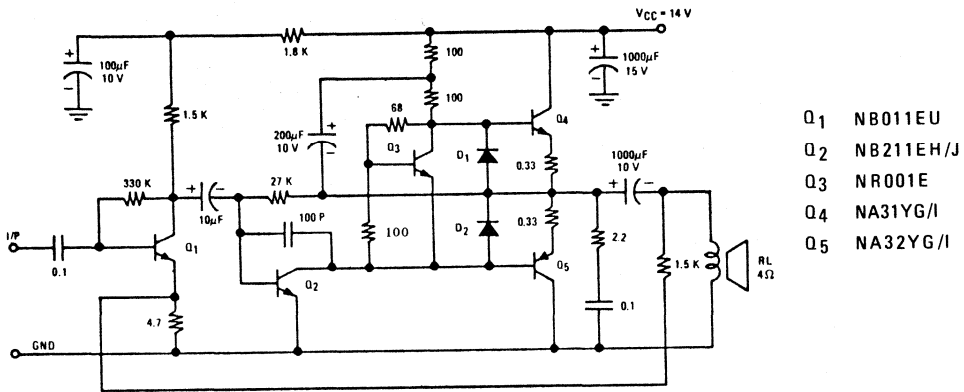

Figure B. 4 Watt / 4 Ohm OTL Amplifier

- Q1 NB011EU
- Q2 NB211EH/J
- Q3 NR001E
- Q4 NA31YG/I
- Q5 NA32YG/I

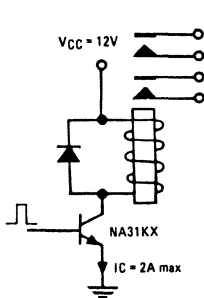

Figure C. Relay Driver

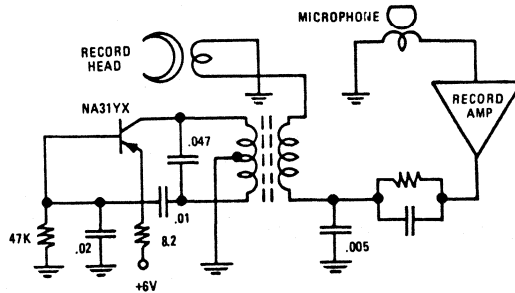

Figure D. Cassette Bias Oscillator



**NA41 (NPN)  
NA42 (PNP) 2.5 Amp complementary power transistors**

**features**

- 30 Volt/2.5 Amp rating
- Available in TO-126 and TO-220 packages
- Low  $V_{CE(sat)}$  and  $V_{BE(sat)}$  characteristics at  $I_C = 1.6 A, I_B = 40 mA$
- Matched HFE groupings for complementary applications
- "Epoxy B" packaging concept for excellent reliability

**applications**

- 4 to 7 Watt, 4 or 8 Ohm audio power amplifiers
- High current switching circuits
- Converter/Inverter circuits
- TV receivers

**1 packages and lead coding**

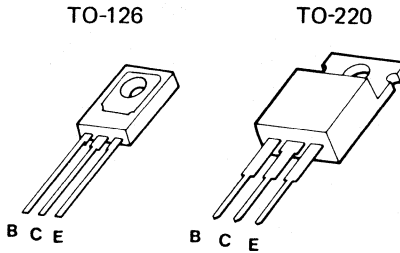

PACKAGE CODE	
TO 126	TO 220
U	W

**2 maximum ratings**

PARAMETER	SYMBOL	RATING	UNIT
Collector-Emitter Voltage	$V_{CE}$	30	$V_{DC}$
Collector-Base Voltage	$V_{CB}$	35	$V_{DC}$
Emitter-Base Voltage	$V_{EB}$	4	$V_{DC}$
Collector Current (continuous)	$I_C (max)$	2.5	A
Power Dissipation ( $T_A = 25^\circ C$ )	$P_D$		
TO-126		1.7	W
TO-220		1.8	W
Power Dissipation ( $T_C = 25^\circ C$ )	$P_D$		
TO-126		25	W
TO-220		25	W
Thermal Resistance			
TO-126	$\theta_{JA}/\theta_{JC}$	73.5/5	$^\circ C/W$
TO-220	$\theta_{JA}/\theta_{JC}$	69.4/5	$^\circ C/W$
Temperature, Junction and Storage	$T_j, T_{stg}$	-55 to + 150	$^\circ C$

**3 ordering information**

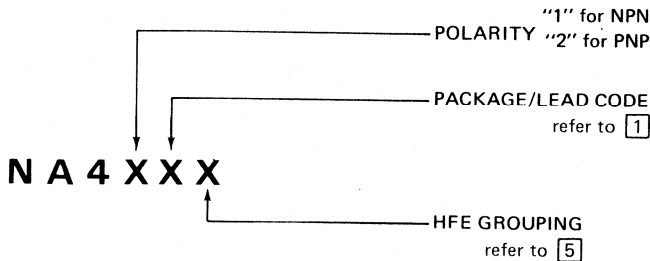

**4** electrical characteristics  $T_C = 25^\circ\text{C}$

SYMBOL	PARAMETER	CONDITIONS	MIN	TYP	MAX	UNIT
$V_{CEER}$	Collector-Emitter Sustaining Voltage	$I_C = 10\text{ mA}, R = 1\text{K}$	30			V
$V_{CBO}$	Collector-Base Breakdown Voltage	$I_C = 100\mu\text{A}$	35			V
$V_{EBO}$	Emitter-Base Breakdown Voltage	$I_E = 100\mu\text{A}$	4			V
$I_{CER}$	Collector-Emitter Leakage Current	$V_{CE} = 20\text{V}, R = 1\text{K}$			500	$\mu\text{A}$
$I_{CBO}$	Collector-Base Leakage Current	$V_{CB} = 25\text{V}$			200	$\mu\text{A}$
$V_{BE}(\text{on})$	Base-Emitter Voltage	$I_C = 10\text{ mA}, V_{CE} = 10\text{V}$	510	590	670	mV
$V_{BE}(\text{sat})$	Base-Emitter Saturation Voltage	$I_C = 1.6\text{A}, I_B = 40\text{ mA}$			1.2	V
$V_{BE}(\text{sat})$	Base-Emitter Saturation Voltage	$I_C = 1.6\text{A}, I_B = 160\text{ mA}$			1.4	V
$V_{CE}(\text{sat})$	Collector-Emitter Saturation Voltage	$I_C = 1.6\text{A}, I_B = 40\text{ mA}$			1.2	V
$V_{CE}(\text{sat})$	Collector-Emitter Saturation Voltage	$I_C = 1.6\text{A}, I_B = 160\text{ mA}$			0.6	V
$C_{ob}$	Collector Output Capacitance	$V_{CB} = 10\text{V}, f = 1\text{ MHz}$				pF
	NPN types			35		pF
	PNP types			65		pF

**5** HFE groupings

GROUPING	PARAMETER	CONDITIONS	MIN	TYP	MAX	RATIO
G	DC Current Gain	$I_C = 300\text{ mA}, V_{CE} = 10\text{V}$	68	85	110	1:1.6
H	DC Current Gain	$I_C = 300\text{ mA}, V_{CE} = 10\text{V}$	100	127	160	1:1.6
I	DC Current Gain	$I_C = 300\text{ mA}, V_{CE} = 10\text{V}$	140	180	240	1:1.6
X	DC Current Gain	$I_C = 300\text{ mA}, V_{CE} = 10\text{V}$	30	58	110	1:3.5
Y	DC Current Gain	$I_C = 300\text{ mA}, V_{CE} = 10\text{V}$	100	190	350	1:3.5

**6** physical dimensions

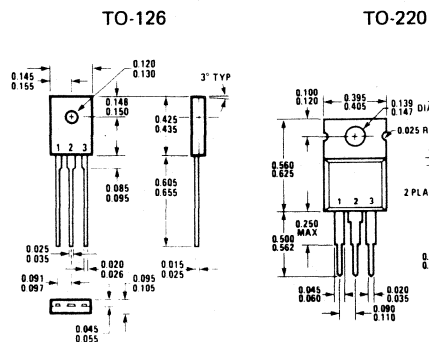

**7** heatsink information

The TO-126 and TO-220 packages used with heatsink shown below permits about 8.7 Watts Power Dissipation and  $\theta_{CA} = 9.4^\circ\text{C/W}$ .

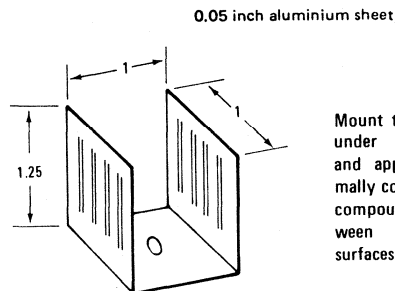

Mount transistor under heatsink and apply thermally conductive compound between contact surfaces.

8 typical performance characteristics

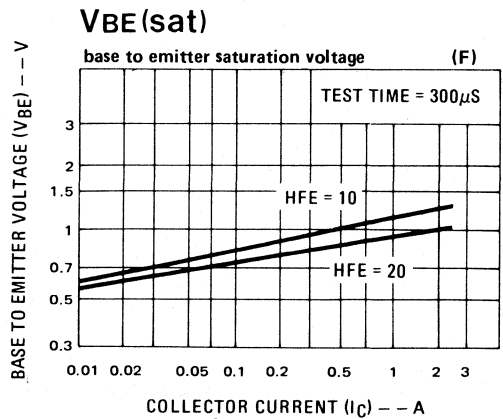
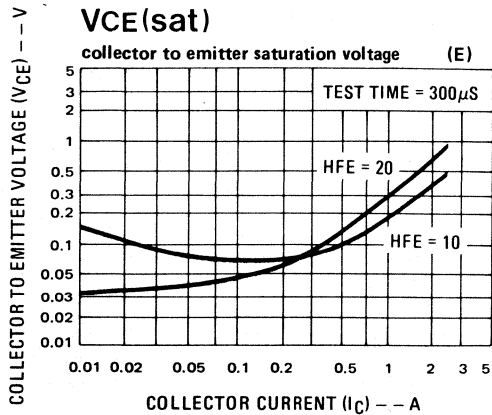
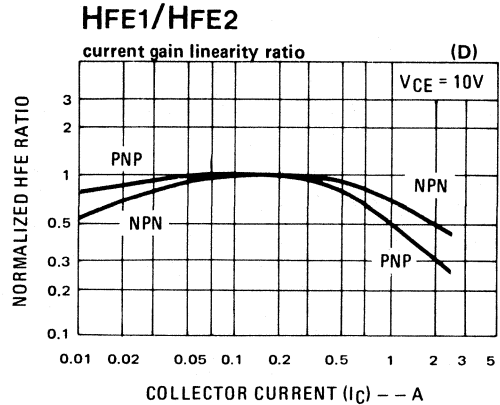
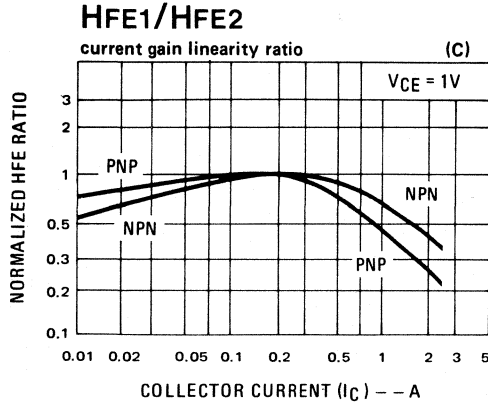
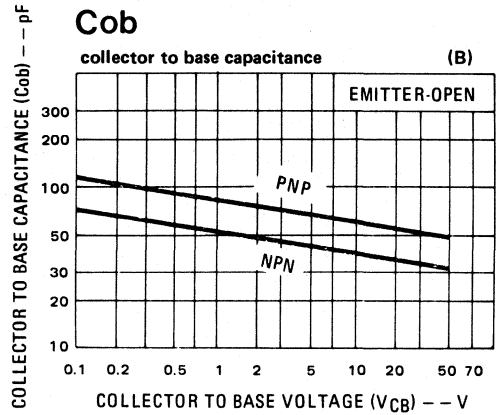
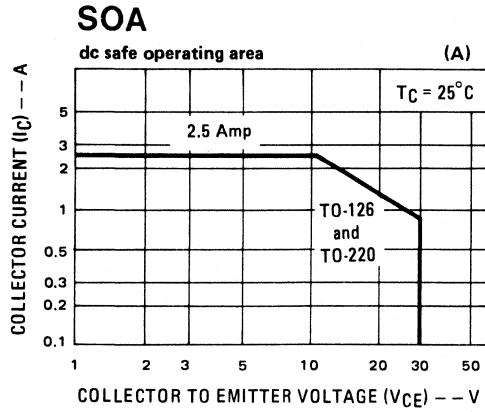

9 typical applications

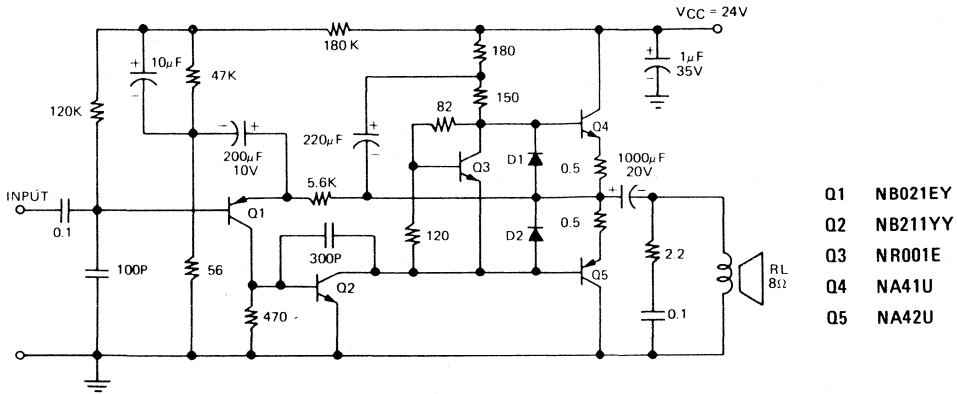

Figure A. 6 Watt, 8 Ohm OTL Amplifier

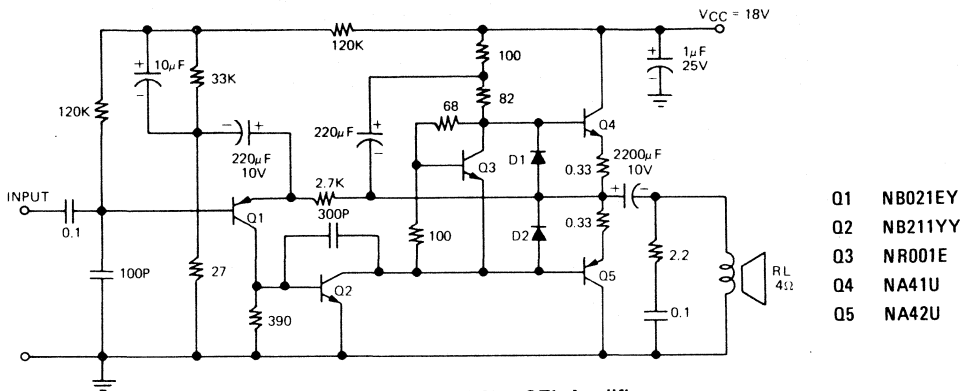

Figure B. 6 Watt, 4 Ohm OTL Amplifier

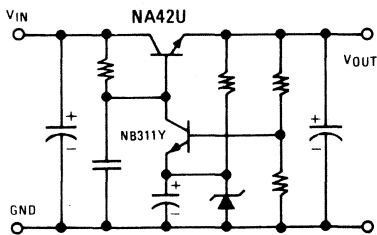

Figure C. Linear Regulator Circuit

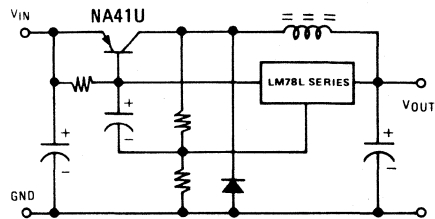

Figure D. Switching Regulator Circuit



**NA51 (NPN)  
NA52 (PNP) 3.5 Amp complementary power transistors**

**features**

- 45 Volt/3.5 Amp rating
- Available in TO-126 and TO-220 packages
- Low  $V_{CE(sat)}$  and  $V_{BE(sat)}$  characteristics at  $I_C = 2A, I_B = 80\text{ mA}$
- Guaranteed  $V_{CE(sat)}$  and  $V_{BE(sat)}$  at  $I_C = 3A, I_B = 160\text{ mA}$  for improved short-circuit protection design in audio amplifier
- "Epoxy B" packaging concept for excellent reliability

**applications**

- 6 to 14 Watt, 4 or 8 Ohm audio power amplifier
- High current switching circuits
- Converter/Inverter circuits
- TV receivers

**1 packages and lead coding**

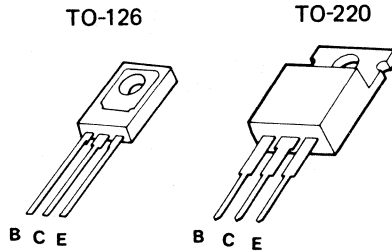

PACKAGE CODE	
TO 126	TO 220
U	W

**2 maximum ratings**

PARAMETER	SYMBOL	RATING	UNIT
Collector-Emitter Voltage	$V_{CE}$	45	$V_{DC}$
Collector-Base Voltage	$V_{CB}$	50	$V_{DC}$
Emitter-Base Voltage	$V_{EB}$	4	$V_{DC}$
Collector Current (continuous)	$I_C (max)$	3.5	A
Power Dissipation ( $T_A = 25^\circ C$ )	$P_D$		
TO-126		1.8	W
TO-220		2.0	W
Power Dissipation ( $T_C = 25^\circ C$ )	$P_D$		
TO-126		30	W
TO-220		30	W
Thermal Resistance			
TO-126	$\theta_{JA}/\theta_{JC}$	69.4/4.17	$^\circ C/W$
TO-220	$\theta_{JA}/\theta_{JC}$	62.5/4.17	$^\circ C/W$
Temperature, Junction and Storage	$T_j, T_{stg}$	-55 to + 150	$^\circ C$

**3 ordering information**

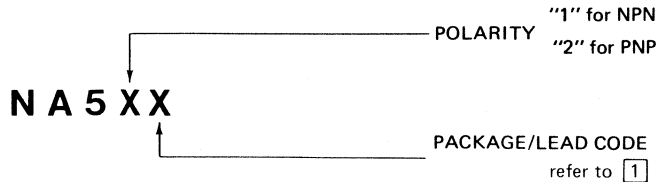

**4** electrical characteristics  $T_C = 25^\circ\text{C}$

SYMBOL	PARAMETER	CONDITIONS	MIN	TYP	MAX	UNIT
$BV_{CER}$	Collector-Emitter Sustaining Voltage	$I_C = 10\text{ mA}, R = 1\text{K}$	45			V
$BV_{CBO}$	Collector-Base Breakdown Voltage	$I_C = 100\mu\text{A}$	50			V
$BV_{EBO}$	Emitter-Base Breakdown Voltage	$I_E = 100\mu\text{A}$	4			V
$I_{CER}$	Collector-Emitter Leakage Current	$V_{CE} = 35\text{V}, R = 1\text{K}$			1	mA
$I_{CBO}$	Collector-Base Leakage Current	$V_{CB} = 40\text{V}$			0.5	mA
$V_{BE}(\text{on})$	Base-Emitter Voltage	$I_C = 15\text{ mA}, V_{CE} = 10\text{V}$	520	600	680	mV
$V_{BE}(\text{sat})$	Base-Emitter Saturation Voltage	$I_C = 2\text{A}, I_B = 80\text{ mA}$			1.3	V
$V_{BE}(\text{sat})$	Base-Emitter Saturation Voltage	$I_C = 3\text{A}, I_B = 160\text{ mA}$			1.6	V
$V_{CE}(\text{sat})$	Collector-Emitter Saturation Voltage	$I_C = 2\text{A}, I_B = 80\text{ mA}$			1.5	V
$V_{CE}(\text{sat})$	Collector-Emitter Saturation Voltage	$I_C = 3\text{A}, I_B = 160\text{ mA}$			5	V
$HFE_1$	DC Current Gain	$I_C = 500\text{ mA}, V_{CE} = 10\text{V}$	30	100		ratio
$C_{ob}$	Collector Output Capacitance	$V_{CB} = 10\text{V}, f = 1\text{ MHz}$				pF
	NPN types			35		pF
	PNP types			65		pF

**5** physical dimensions

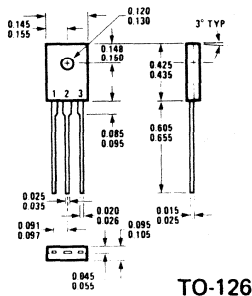

TO-126

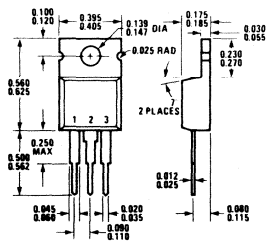

TO-220

**6** heatsink information

The TO-126 and TO-220 packages used with heatsink shown below permits about 9.2 Watts power dissipation and  $\theta_{CA} = 9.4^\circ\text{C/W}$ .

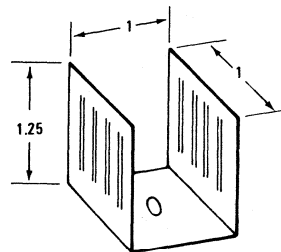

0.05 inch aluminium sheet

Mount transistor under heatsink and apply thermally conductive compound between contact surfaces.

7 typical performance characteristics

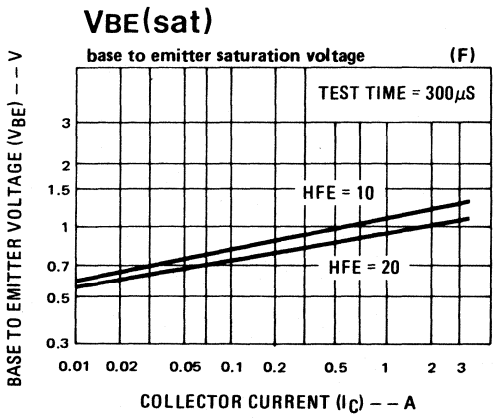
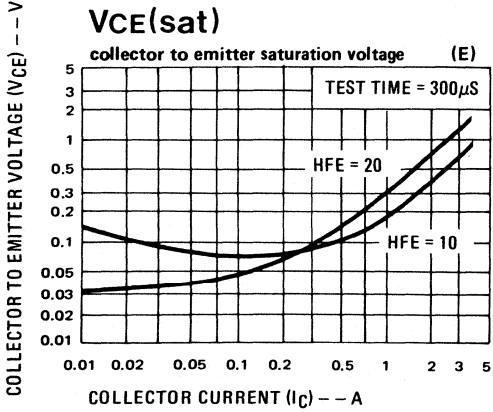
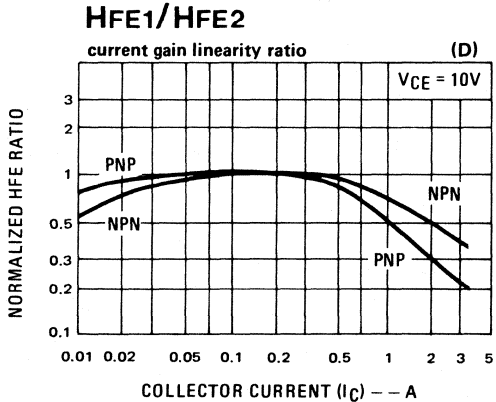
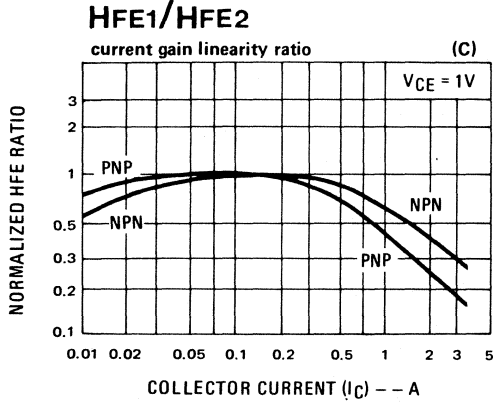
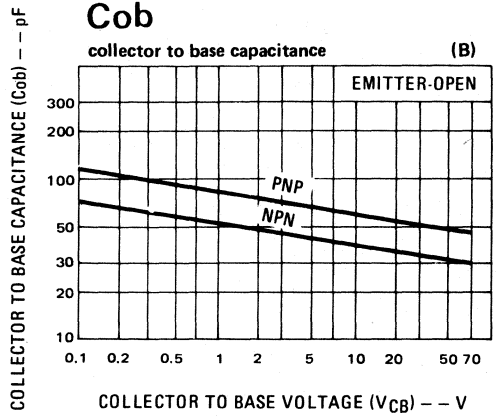
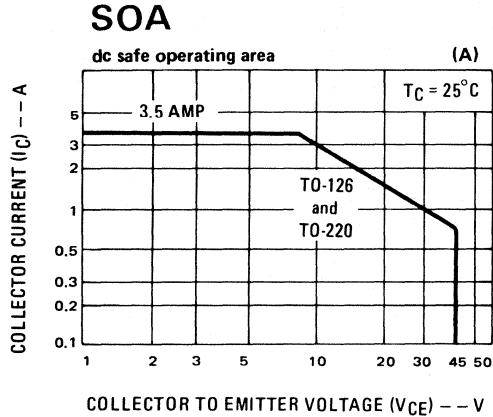



8 typical applications

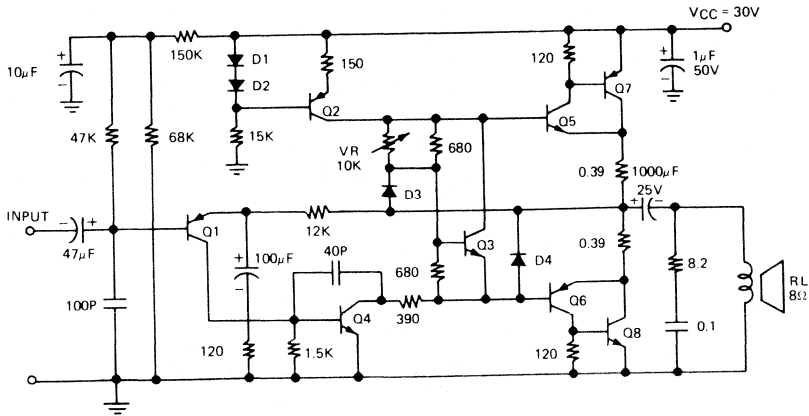

- Q1 NB021EY
- Q2 NB122EY
- Q3 NR001E
- Q4 NB112EY
- Q5 NB312E
- Q6 NB322E
- Q7 NA52W
- Q8 NA51W

Figure A. 12 Watt, 8 Ohm OTL Amplifier

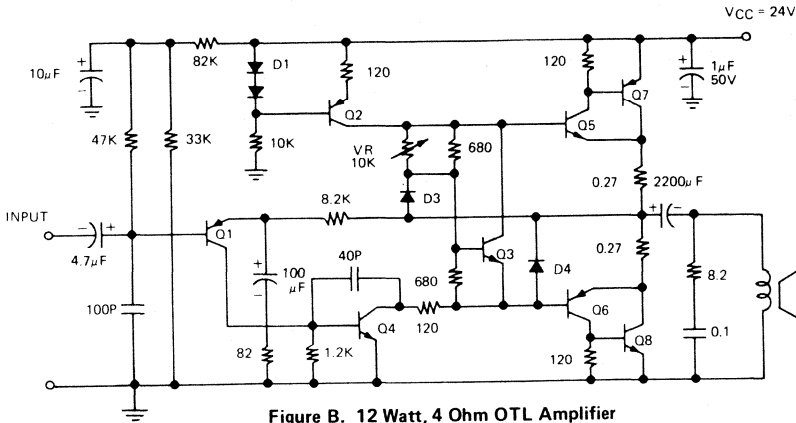

- Q1 NB021EY
- Q2 NB122EY
- Q3 NR001E
- Q4 NB112EY
- Q5 NB312E
- Q6 NB322E
- Q7 NA52W
- Q8 NA51W

Figure B. 12 Watt, 4 Ohm OTL Amplifier

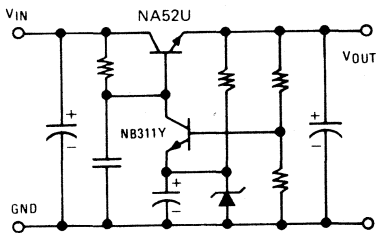

Figure C. Linear Regulator Circuit

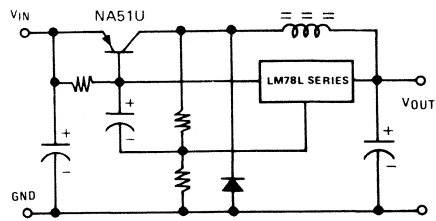

Figure D. Switching Regulator Circuit



**NA61 (NPN)  
NA62 (PNP) 4.5 Amp complementary power transistors**

**features**

- 45 Volt/4.5 Amp rating
- Available in TO-126 and TO-220 packages
- Low  $V_{CE(sat)}$  and  $V_{BE(sat)}$  characteristics at  $I_C = 3A, I_B = 150 mA$
- Guaranteed  $V_{CE(sat)}$  and  $V_{BE(sat)}$  at  $I_C = 4.5A, I_B = 300 mA$  for improved short-circuit protection design in audio amplifiers
- "Epoxy B" packaging concept for excellent reliability

**1 packages and lead coding**

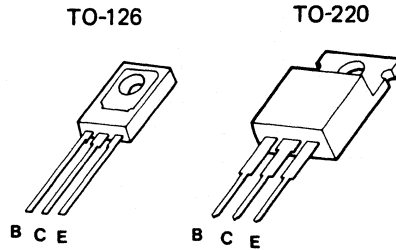

**applications**

- 10 to 25 Watt, 4 Ohm audio power amplifiers
- High current switching circuits
- Converter/Inverter circuits
- TV receivers

PACKAGE CODE	
TO 126	TO 220
U	W

**2 maximum ratings**

PARAMETER	SYMBOL	RATING	UNIT
Collector-Emitter Voltage	$V_{CE}$	45	$V_{DC}$
Collector-Base Voltage	$V_{CB}$	50	$V_{DC}$
Emitter-Base Voltage	$V_{EB}$	4	$V_{DC}$
Collector Current (continuous)	$I_C (max)$	4.5	A
Power Dissipation ( $T_A = 25^\circ C$ )	$P_D$		
TO-126		1.8	W
TO-220		2.0	W
Power Dissipation ( $T_C = 25^\circ C$ )	$P_D$		
TO-126		40	W
TO-220		40	W
Thermal Resistance			
TO-126	$\theta_{JA}/\theta_{JC}$	69.4/3.125	$^\circ C/W$
TO-220	$\theta_{JA}/\theta_{JC}$	62.5/3.125	$^\circ C/W$
Temperature, Junction and Storage	$T_j, T_{stg}$	-55 to +150	$^\circ C$

**3 ordering information**

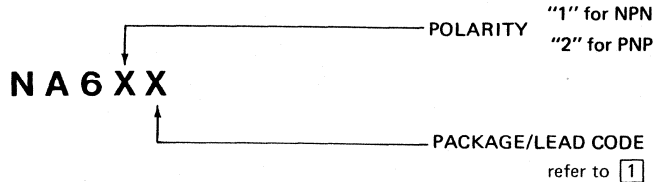

**4** electrical characteristics  $T_C = 25^\circ\text{C}$

SYMBOL	PARAMETER	CONDITIONS	MIN	TYP	MAX	UNIT
$BV_{CER}$	Collector-Emitter Sustaining Voltage	$I_C = 10\text{ mA}, R = 1\text{K}$	45			V
$BV_{CBO}$	Collector-Base Breakdown Voltage	$I_C = 100\mu\text{A}$	50			V
$BV_{EBO}$	Emitter-Base Breakdown Voltage	$I_E = 100\mu\text{A}$	4			V
$I_{CER}$	Collector-Emitter Leakage Current	$V_{CE} = 35\text{V}, R = 1\text{K}$			2	mA
$I_{CBO}$	Collector-Base Leakage Current	$V_{CB} = 40\text{V}$			1	mA
$V_{BE}(\text{on})$	Base-Emitter Voltage	$I_C = 20\text{ mA}, V_{CE} = 10\text{V}$	520	600	680	mV
$V_{BE}(\text{sat})$	Base-Emitter Saturation Voltage	$I_C = 3\text{A}, I_B = 150\text{ mA}$			1.5	V
$V_{BE}(\text{sat})$	Base-Emitter Saturation Voltage	$I_C = 4.5\text{A}, I_B = 300\text{ mA}$			2	V
$V_{CE}(\text{sat})$	Collector-Emitter Saturation Voltage	$I_C = 3\text{A}, I_B = 150\text{ mA}$			2	V
$V_{CE}(\text{sat})$	Collector-Emitter Saturation Voltage	$I_C = 4.5\text{A}, I_B = 300\text{ mA}$			5	V
$HFE_1$	DC Current Gain	$I_C = 500\text{ mA}, V_{CE} = 10\text{V}$	30	100		ratio
$C_{ob}$	Collector Output Capacitance	$V_{CB} = 10\text{V}, f = 1\text{ MHz}$				pF
	NPN types			40		pF
	PNP types			70		pF

**5** physical dimensions

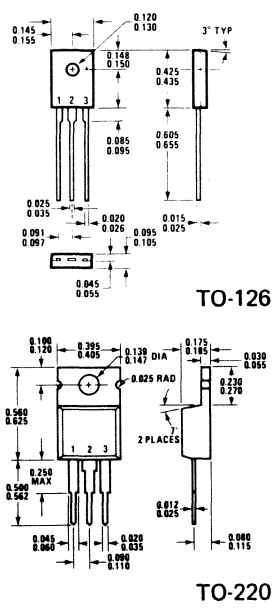

**6** heatsink information

The TO-126 and TO-220 packages used with heatsink shown below permits about 10 Watts power dissipation and  $\theta_{CA} = 9.4^\circ\text{C/W}$ .

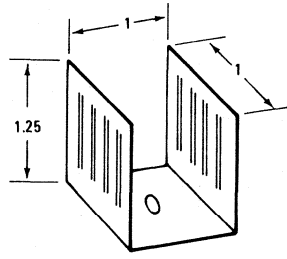

0.05 inch aluminium sheet

Mount transistor under heatsink and apply thermally conductive compound between contact surfaces.

7 typical performance characteristics

SOA

dc safe operating area

(A)

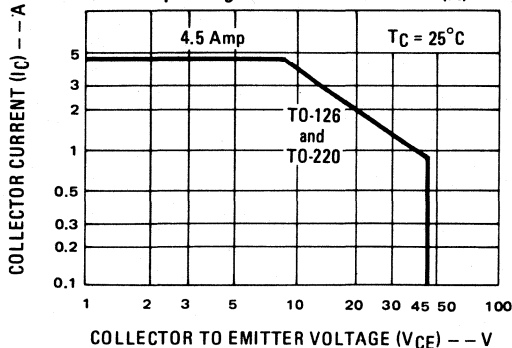

Cob

collector to base capacitance

(B)

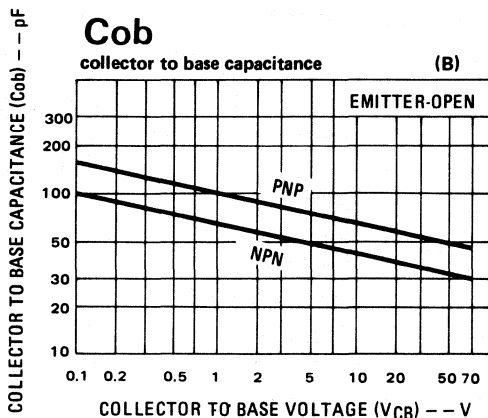

HFE1/HFE2

current gain linearity ratio

(C)

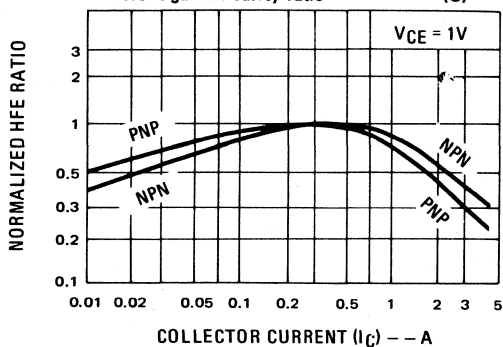

HFE1/HFE2

current gain linearity ratio

(D)

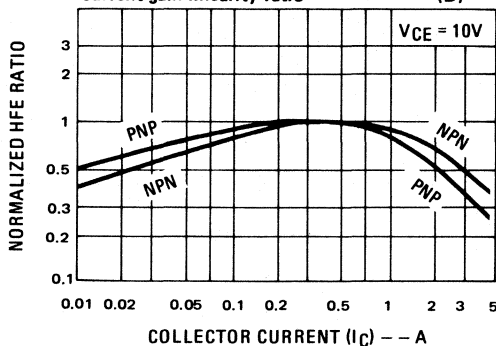

VCE(sat)

collector to emitter saturation voltage

(E)

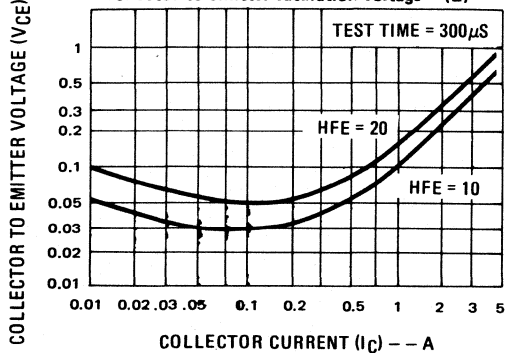

VBE(sat)

base to emitter saturation voltage

(F)

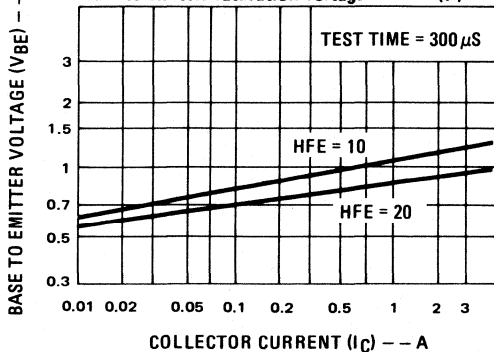

**8** typical applications

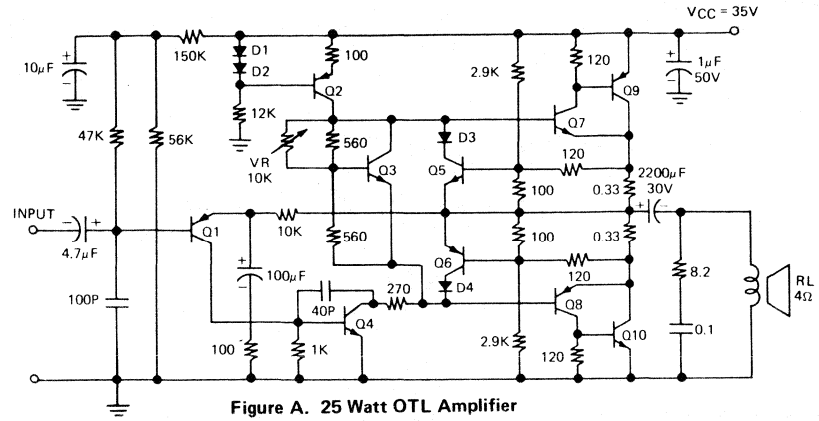

**Figure A. 25 Watt OTL Amplifier**

- Q1 NB022EY
- Q2 NB123EY
- Q3 NR001E
- Q4 NB113EY
- Q5 NB111EY
- Q6 NB121EY
- Q7 NB313Y
- Q8 NB323Y
- Q9 NA62W
- Q10 NA61W

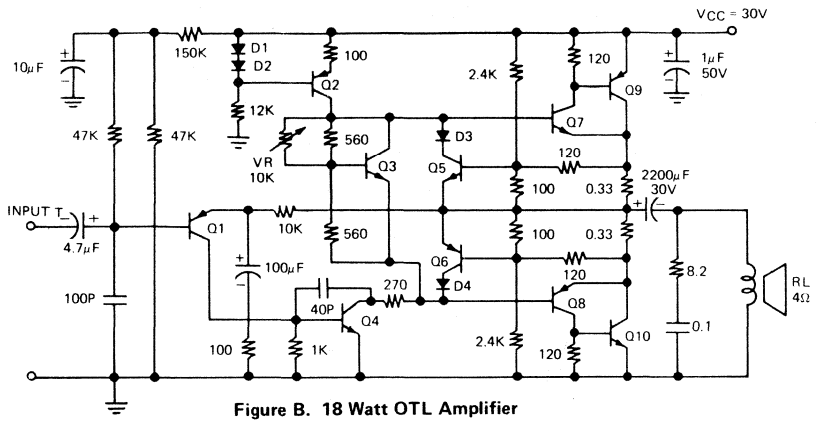

**Figure B. 18 Watt OTL Amplifier**

- Q1 NB022EY
- Q2 NB122EY
- Q3 NR001E
- Q4 NB112EY
- Q5 NB111EY
- Q6 NB121EY
- Q7 NB313Y
- Q8 NB323Y
- Q9 NA62W
- Q10 NA61W

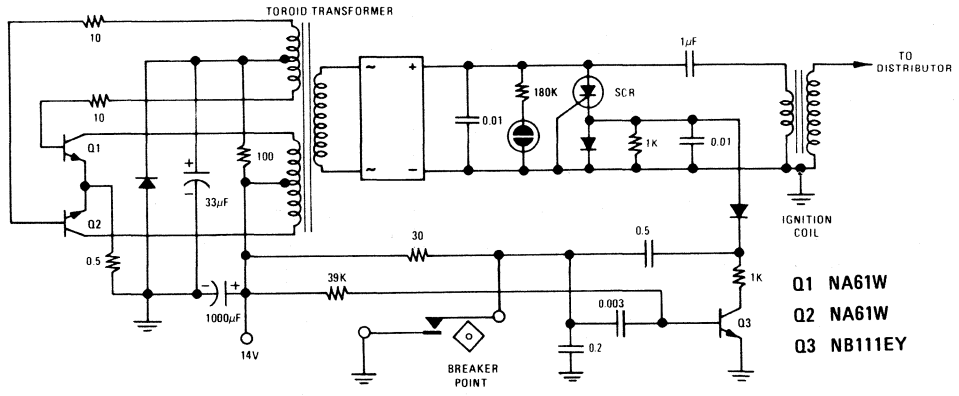

**Figure C. Capacitor Discharge Ignition System**

- Q1 NA61W
- Q2 NA61W
- Q3 NB111EY



## NA71 (NPN) NA72 (PNP) 3.5 Amp complementary power transistors

### features

- 60 Volt/3.5 Amp rating
- Available in TO-126 and TO-220 packages
- Low  $V_{CE} (sat)$  and  $V_{BE} (sat)$  characteristics at  $I_C = 2 A, I_B = 100mA$
- Guaranteed  $V_{CE} (sat)$  and  $V_{BE} (sat)$  at  $I_C = 3A, I_B = 200mA$  for improved short circuited protection design in audio amplifiers
- "Epoxy B" packaging concept for excellent reliability

### applications

- 10–25 Watt 8 Ohm audio power amplifiers
- High current switching circuits
- Converter/Inverter circuits
- TV receivers

### 1 packages and lead coding

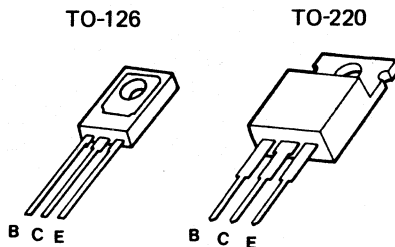

PACKAGE CODE	
TO 126	TO 220
U	W

### 2 maximum ratings

PARAMETER	SYMBOL	RATING	UNIT
Collector-Emitter Voltage	$V_{CE}$	60	$V_{DC}$
Collector-Base Voltage	$V_{CB}$	65	$V_{DC}$
Emitter-Base Voltage	$V_{EB}$	4	$V_{DC}$
Collector Current (continuous)	$I_C (max)$	3.5	A
Power Dissipation ( $T_A = 25^\circ C$ )	$P_D$		
TO-126		1.8	W
TO-220		2.0	W
Power Dissipation ( $T_C = 25^\circ C$ )	$P_D$		
TO-126		40	W
TO-220		40	W
Thermal Resistance			
TO-126	$\theta_{JA}/\theta_{JC}$	69.4/3.125	$^\circ C/W$
TO-220	$\theta_{JA}/\theta_{JC}$	62.5/3.125	$^\circ C/W$
Temperature, Junction and Storage	$T_j, T_{stg}$	-55 to +150	$^\circ C$

### 3 ordering information

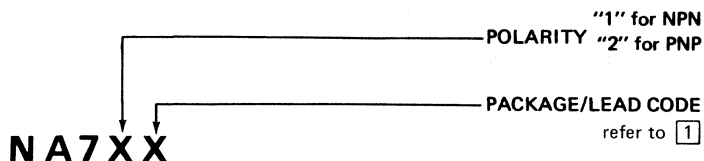

**4** electrical characteristics  $T_C = 25^\circ\text{C}$

SYMBOL	PARAMETER	CONDITIONS	MIN	TYP	MAX	UNIT
$BV_{CER}$	Collector-Emitter Sustaining Voltage	$I_C = 10\text{ mA}, R = 1\text{K}$	60			V
$BV_{CBO}$	Collector-Base Breakdown Voltage	$I_C = 100\ \mu\text{A}$	65			V
$BV_{EBO}$	Emitter-Base Breakdown Voltage	$I_E = 100\ \mu\text{A}$	4			V
$I_{CER}$	Collector-Emitter Leakage Current	$V_{CE} = 50\text{V}, R = 1\text{K}$			2	mA
$I_{CBO}$	Collector-Base Leakage Current	$V_{CB} = 55\text{V}$			1	mA
$V_{BE}(\text{on})$	Base-Emitter Voltage	$I_C = 20\text{ mA}, V_{CE} = 10\text{V}$	520	600	680	mV
$V_{BE}(\text{sat})$	Base-Emitter Saturation Voltage	$I_C = 2\text{A}, I_B = 100\text{ mA}$			1.5	V
$V_{BE}(\text{sat})$	Base-Emitter Saturation Voltage	$I_C = 3\text{A}, I_B = 200\text{ mA}$			2	V
$V_{CE}(\text{sat})$	Collector-Emitter Saturation Voltage	$I_C = 2\text{A}, I_B = 100\text{ mA}$			2	V
$V_{CE}(\text{sat})$	Collector-Emitter Saturation Voltage	$I_C = 3\text{A}, I_B = 200\text{ mA}$			5	V
$HFE_1$	DC Current Gain	$I_C = 500\text{ mA}, V_{CE} = 10\text{V}$	30	100		ratio
$C_{ob}$	Collector Output Capacitance NPN types PNP types	$V_{CB} = 10\text{V}, f = 1\text{ MHz}$		40 70		pF pF

**5** physical dimensions

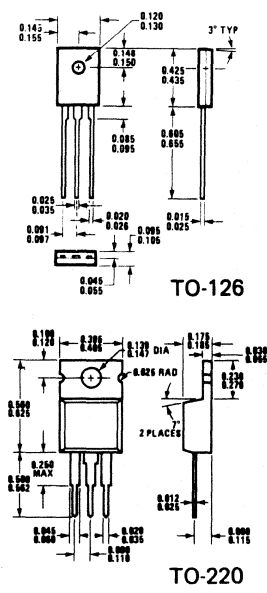

**6** heatsink information

The TO-126 and TO-220 packages used with heatsink shown below permits about 10 Watts power dissipation and  $\theta_{CA} = 9.4^\circ\text{C/W}$ .

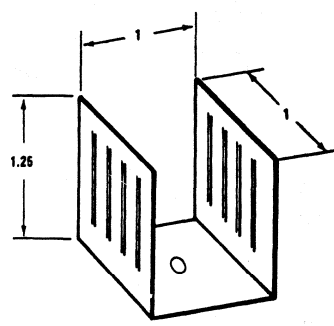

0.05 inch aluminium sheet

Mount transistor under heatsink and apply thermally conductive compound between contact surfaces.

7 typical performance characteristics

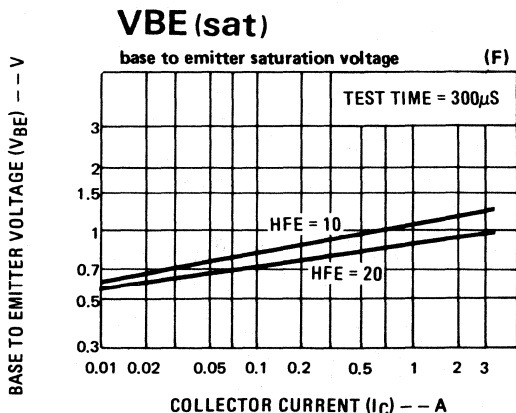
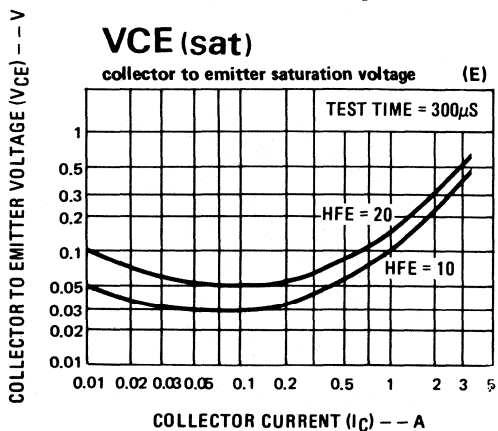
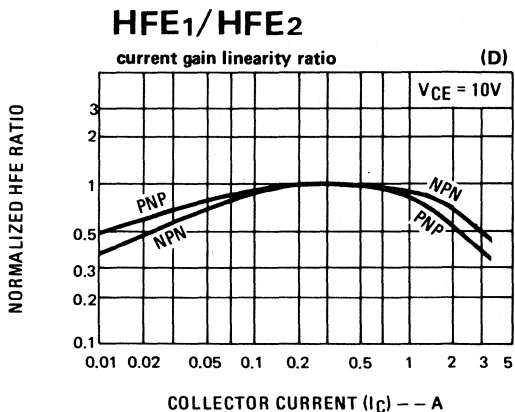
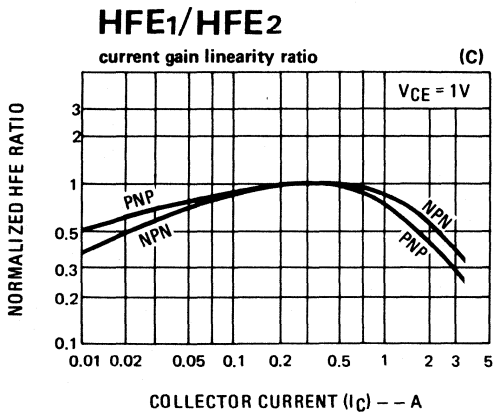
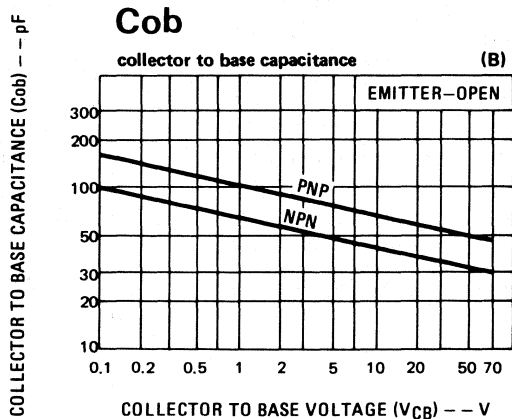
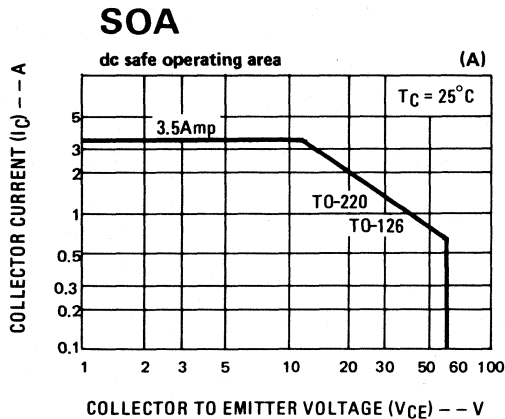



# 8 typical applications

NA71(NPN), NA72(PNP)

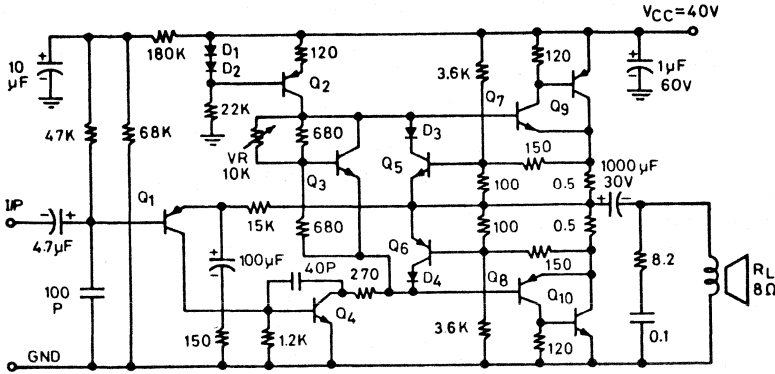

- Q1 NB022EY
- Q2 NB123EY
- Q3 NR001E
- Q4 NB113EY
- Q5 NB111EY
- Q6 NB121EY
- Q7 NB313Y
- Q8 NB323Y
- Q9 NA72W
- Q10 NA71W

Figure A. 25 Watt OTL Amplifier

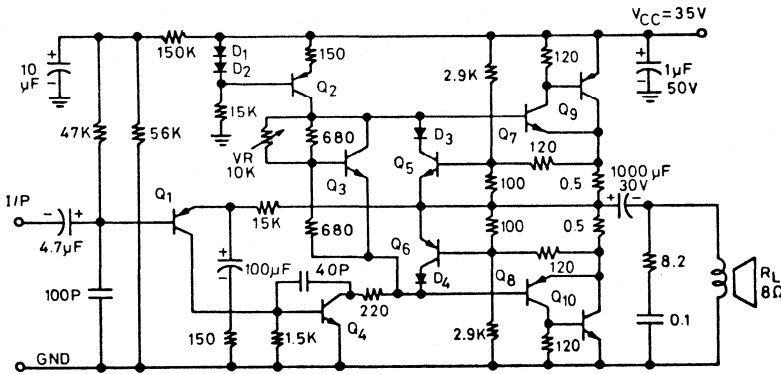

- Q1 NB022EY
- Q2 NB123EY
- Q3 NR001E
- Q4 NB113EY
- Q5 NB111EY
- Q6 NB121EY
- Q7 NB313Y
- Q8 NB323Y
- Q9 NA72W
- Q10 NA71W

Figure B. 18 Watt OTL Amplifier

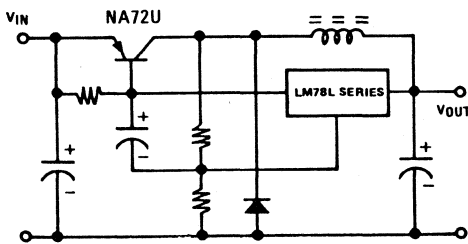

Figure C. Switching Regulator Circuit

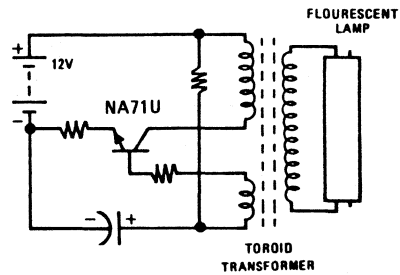

Figure D. Battery Lantern Circuit



**NB011,012 (NPN) NB021,022 (PNP) 30mA general purpose transistors**

**features**

- 35 to 50 Volt at 30 mA collector ratings
- 300 mV guaranteed  $V_{CE}$  (sat) characteristics at  $I_C = 10$  mA and  $I_B = 0.5$  mA
- Matched HFE groupings for complementary applications
- "Epoxy B" packaging concept for excellent reliability

**1 package and lead coding**

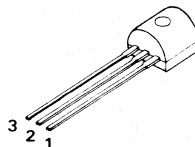

**applications**

- Small signal amplifier circuits
- Equalizer preamplifiers
- Low current switching circuits
- TV receivers

PACKAGE CODE TO-92	LEAD		
	1	2	3
E	E	B	C
F	E	C	B
H	C	B	E

**2 maximum ratings**

PARAMETER	SYMBOL	NB011 NB021	NB012 NB022	UNIT
Collector-Emitter Voltage	$V_{CEO}$	35	50	$V_{DC}$
Collector-Base Voltage	$V_{CB}$	40	55	$V_{DC}$
Emitter-Base Voltage	$V_{EB}$	5	5	$V_{DC}$
Collector Current (continuous)	$I_C$ (max)	30	30	mA <sub>DC</sub>
Power Dissipation ( $T_A = 25^\circ\text{C}$ )	$P_D$	0.6	0.6	W
Power Dissipation ( $T_C = 25^\circ\text{C}$ )	$P_D$	1.0	1.0	W
Thermal Resistance	$\theta_{JA}$	208	208	$^\circ\text{C}/\text{W}$
	$\theta_{JC}$	125	125	$^\circ\text{C}/\text{W}$
Temperature, Junction and Storage	$T_j, T_{stg}$	-55 to + 150	-55 to + 150	$^\circ\text{C}$

**3 ordering information**

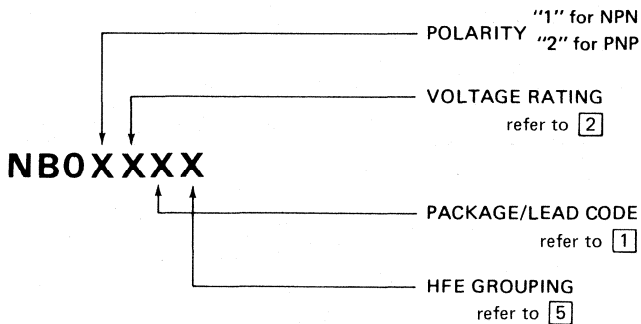

**4 electrical characteristics**  $T_C = 25^\circ\text{C}$

SYMBOL	PARAMETER	CONDITIONS	MIN	TYP	MAX	UNIT
BV <sub>CEO</sub>	Collector-Emitter Sustaining Voltage NB011/021 NB012/022	I <sub>C</sub> = 1 mA	35			V
			50			V
BV <sub>CB0</sub>	Collector-Base Breakdown Voltage NB011/021 NB012/022	I <sub>C</sub> = 100μA	40			V
			55			V
BV <sub>EBO</sub>	Emitter-Base Breakdown Voltage	I <sub>E</sub> = 10μA	5			V
I <sub>CEO</sub>	Collector-Emitter Leakage Current	V <sub>CE</sub> = 30V NB011/021 45V NB012/022			1	μA
					1	μA
I <sub>CB0</sub>	Collector-Base Leakage Current	V <sub>CB</sub> = 35V NB011/021 50V NB012/022			0.1	μA
					0.1	μA
I <sub>EBO</sub>	Emitter-Base Leakage Current	V <sub>EB</sub> = 4V			0.1	μA
V <sub>BE</sub> (sat)	Base-Emitter Saturation Voltage	I <sub>C</sub> = 10 mA, I <sub>B</sub> = 0.5 mA		0.75	0.95	V
V <sub>CE</sub> (sat)	Collector-Emitter Saturation Voltage	I <sub>C</sub> = 10 mA, I <sub>B</sub> = 0.5 mA		0.1	0.3	V
C <sub>ob</sub>	Collector Output Capacitance NPN types PNP types	V <sub>CB</sub> = 10V, f = 1 MHz		2		pF
				3		pF
f <sub>t</sub>	Current Gain Bandwidth Product	I <sub>C</sub> = 1 mA, V <sub>CE</sub> = 5V	50	120		MHz

**5 HFE groupings**

GROUPING	PARAMETER	CONDITIONS	MIN	TYP	MAX	RATIO
I	DC Current Gain	I <sub>C</sub> = 1 mA, V <sub>CE</sub> = 5V	140	180	240	1:1.6
J	DC Current Gain	I <sub>C</sub> = 1 mA, V <sub>CE</sub> = 5V	200	260	350	1:1.6
K	DC Current Gain	I <sub>C</sub> = 1 mA, V <sub>CE</sub> = 5V	300	380	500	1:1.6
L	DC Current Gain	I <sub>C</sub> = 1 mA, V <sub>CE</sub> = 5V	450	580	750	1:1.6
T	DC Current Gain	I <sub>C</sub> = 1 mA, V <sub>CE</sub> = 5V	100	150	240	1:2.4
U	DC Current Gain	I <sub>C</sub> = 1 mA, V <sub>CE</sub> = 5V	200	320	500	1:2.4
V	DC Current Gain	I <sub>C</sub> = 1 mA, V <sub>CE</sub> = 5V	450	700	1100	1:2.4
Y	DC Current Gain	I <sub>C</sub> = 1 mA, V <sub>CE</sub> = 5V	100	190	350	1:3.5
Z	DC Current Gain	I <sub>C</sub> = 1 mA, V <sub>CE</sub> = 5V	300	580	1100	1:3.5

**6 physical dimensions**

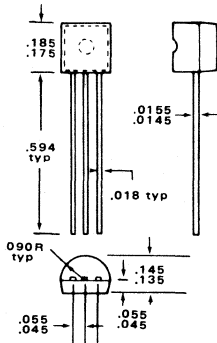

**7 max power dissipation**

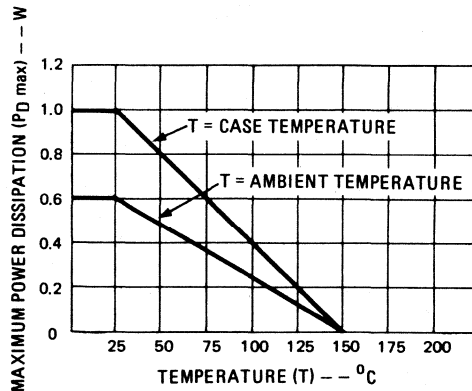

8

## typical performance characteristics

**HFE1/HFE2**

current gain linearity ratio

(A)

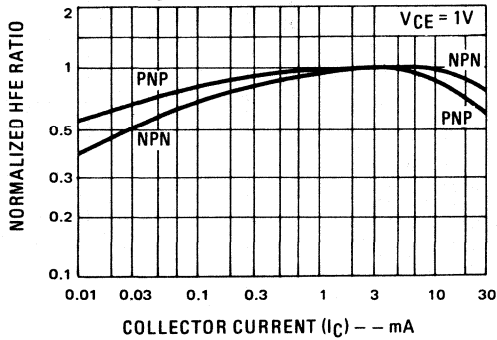
**HFE1/HFE2**

current gain linearity ratio

(B)

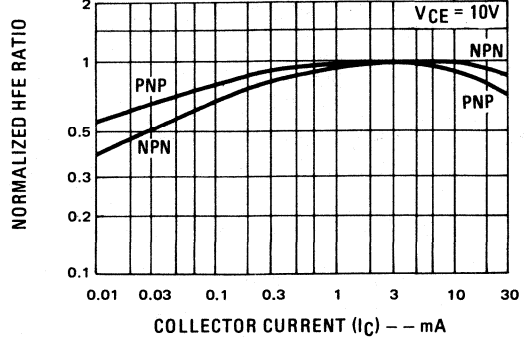
**VCE(sat)**

collector to emitter saturation voltage

(C)

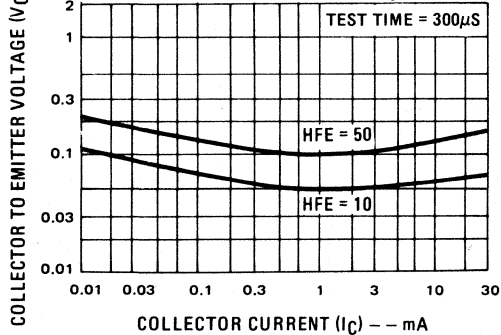
**VBE(sat)**

base to emitter saturation voltage

(D)

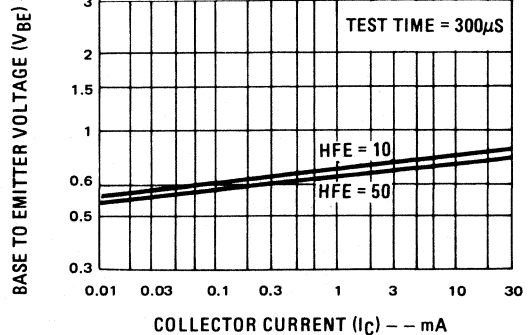
**Cob**

output capacitance

(E)

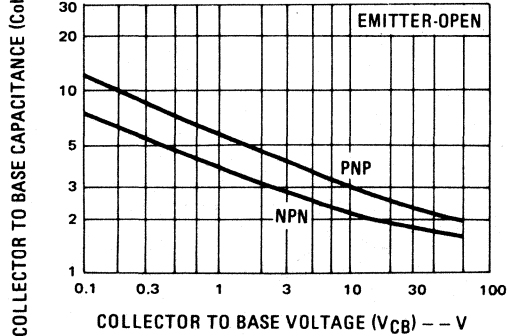
**hoe**

common emitter output admittance

(F)

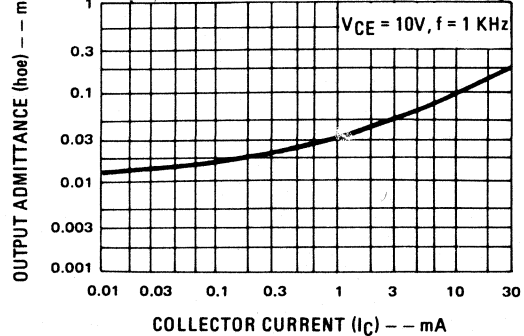

# 9 typical applications

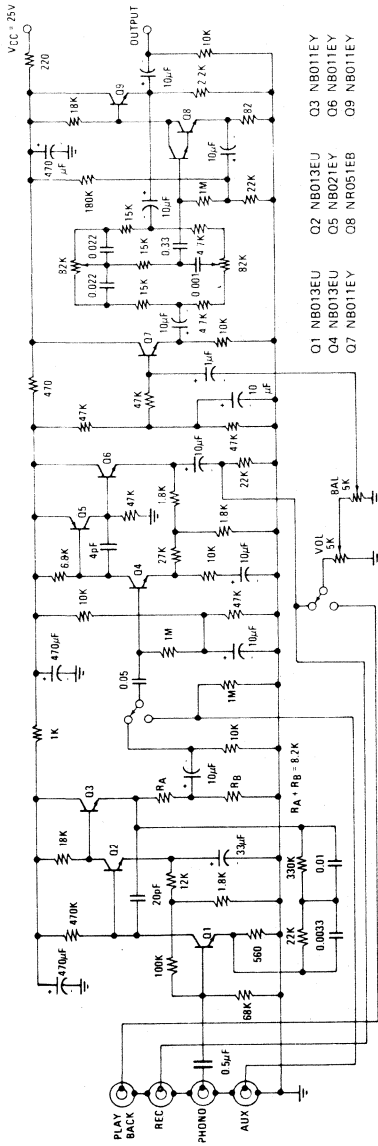

- Q1 NB013EU
- Q2 NB013EU
- Q3 NB011EY
- Q4 NB013EU
- Q5 NB021EY
- Q6 NB011EY
- Q7 NB011EY
- Q8 NR051EB
- Q9 NB011EY

Figure A. High Quality Preamp with Tone Control Circuit

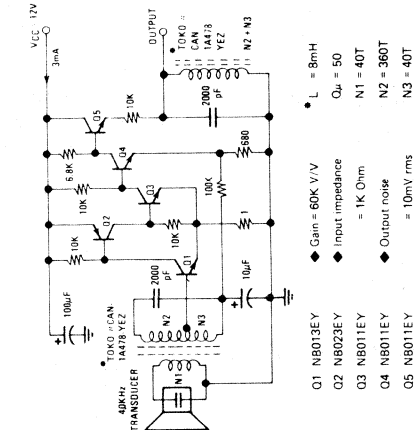

- Q1 NB013EY
  - Q2 NB023EY
  - Q3 NB011EY
  - Q4 NB011EY
  - Q5 NB011EY
- Gain = 8mH  
 Qu = 50  
 Input impedance = 1K Ohm  
 Output noise = 10mV rms

Figure C. High Gain Ultrasonic Amplifier

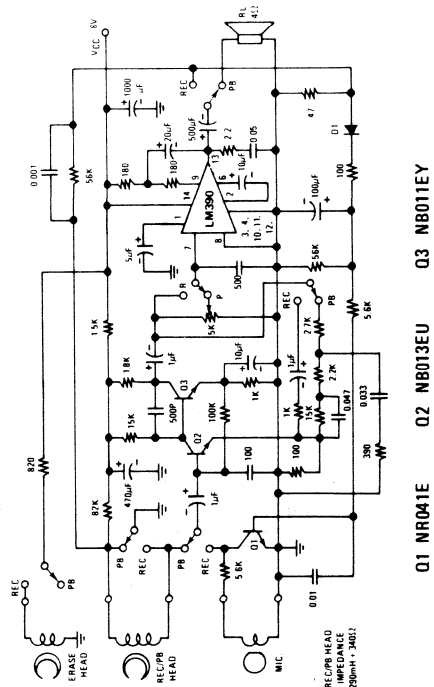

- Q1 NR041E
- Q2 NB013EU
- Q3 NB011EY

Figure B. Battery Operated Recording/Playback Cassette Circuit





**NB013, 014 (NPN)  
NB023, 024 (PNP) 30mA low noise transistors**

**features**

- 35 to 50 Volt at 30mA collector ratings
- 300mV guaranteed  $V_{CE}$  (sat) characteristics at  $I_C = 10mA$  and  $I_B = 0.5mA$
- 1dB typical wide-band Noise Figure
- "Epoxy B" packaging concept for excellent reliability

**applications**

- Low noise amplifier circuits
- Equalizer, preamplifiers

**1 package and lead coding**

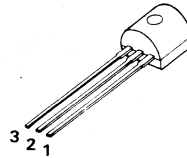

PACKAGE CODE TO-92	LEAD		
	1	2	3
E	E	B	C
F	E	C	B
H	C	B	E

**2 maximum ratings**

PARAMETER	SYMBOL	NB013 NB023	NB014 NB024	UNIT
Collector-Emitter Voltage	$V_{CEO}$	35	50	$V_{DC}$
Collector-Base Voltage	$V_{CB}$	40	55	$V_{DC}$
Emitter-Base Voltage	$V_{EB}$	5	5	$V_{DC}$
Collector Current (continuous)	$I_C$ (max)	30	30	$mA_{DC}$
Power Dissipation ( $T_A = 25^\circ C$ )	$P_D$	0.6	0.6	W
Power Dissipation ( $T_C = 25^\circ C$ )	$P_D$	1.0	1.0	W
Thermal Resistance	$\theta_{JA}$	208	208	$^\circ C/W$
	$\theta_{JC}$	125	125	$^\circ C/W$
Temperature, Junction and Storage	$T_j, T_{stg}$	-55 to + 150	-55 to + 150	$^\circ C$

**3 ordering information**

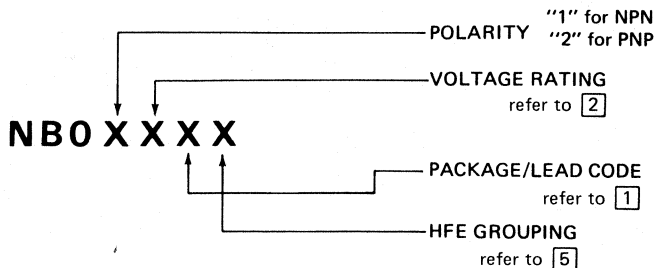

**4** electrical characteristics  $T_C = 25^\circ\text{C}$

SYMBOL	PARAMETER	CONDITIONS	MIN	TYP	MAX	UNIT
$BV_{CEO}$	Collector-Emitter Sustaining Voltage NB013/023 NB014/024	$I_C = 1\text{ mA}$	35 50			V V
$BV_{CBO}$	Collector-Base Breakdown Voltage NB013/023 NB014/024	$I_C = 100\mu\text{A}$	40 55			V V
$BV_{EBO}$	Emitter-Base Breakdown Voltage	$I_E = 10\mu\text{A}$	5			V
$I_{CEO}$	Collector-Emitter Leakage Current	$V_{CE} = 30\text{V}$ NB013/023 $45\text{V}$ NB014/024			1 1	$\mu\text{A}$ $\mu\text{A}$
$I_{CBO}$	Collector-Base Leakage Current	$V_{CB} = 35\text{V}$ NB013/023 $50\text{V}$ NB014/024			50 50	nA nA
$I_{EBO}$	Emitter-Base Leakage Current	$V_{EB} = 4\text{V}$			0.1	$\mu\text{A}$
$V_{BE}(\text{sat})$	Base-Emitter Saturation Voltage	$I_C = 10\text{ mA}$ , $I_B = 0.5\text{ mA}$		0.75	0.95	V
$V_{CE}(\text{sat})$	Collector-Emitter Saturation Voltage	$I_C = 10\text{ mA}$ , $I_B = 0.5\text{ mA}$		0.1	0.3	V
$C_{ob}$	Collector Output Capacitance NPN types PNP types	$V_{CB} = 10\text{V}$ , $f = 1\text{ MHz}$		2 3		pF pF
$f_t$	Current Gain Bandwidth Product	$I_C = 1\text{ mA}$ , $V_{CE} = 5\text{V}$	50	120		MHz
NF	Noise Figure	$I_C = 10\mu\text{A}$ , $V_{CE} = 5\text{V}$ $R_S = 10\text{ K}$ , BW = 15.7 KHz		1	4	dB

**5** HFE groupings

GROUPING	PARAMETER	CONDITIONS	MIN	TYP	MAX	RATIO
I	DC Current Gain	$I_C = 100\mu\text{A}$ , $V_{CE} = 5\text{V}$	140	180	240	1:1.6
J	DC Current Gain	$I_C = 100\mu\text{A}$ , $V_{CE} = 5\text{V}$	200	260	350	1:1.6
K	DC Current Gain	$I_C = 100\mu\text{A}$ , $V_{CE} = 5\text{V}$	300	380	500	1:1.6
L	DC Current Gain	$I_C = 100\mu\text{A}$ , $V_{CE} = 5\text{V}$	450	580	750	1:1.6
T	DC Current Gain	$I_C = 100\mu\text{A}$ , $V_{CE} = 5\text{V}$	100	150	240	1:2.4
U	DC Current Gain	$I_C = 100\mu\text{A}$ , $V_{CE} = 5\text{V}$	200	320	500	1:2.4
V	DC Current Gain	$I_C = 100\mu\text{A}$ , $V_{CE} = 5\text{V}$	450	700	1100	1:2.4
Y	DC Current Gain	$I_C = 100\mu\text{A}$ , $V_{CE} = 5\text{V}$	100	190	350	1:3.5
Z	DC Current Gain	$I_C = 100\mu\text{A}$ , $V_{CE} = 5\text{V}$	300	580	1100	1:3.5

**6** physical dimensions

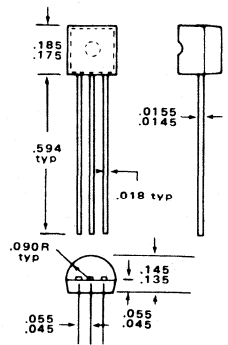

**7** max power dissipation

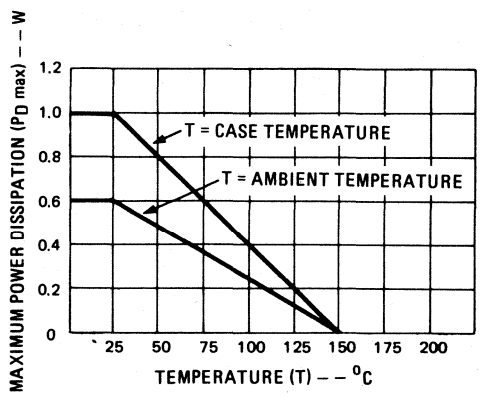

**8** typical performance characteristics

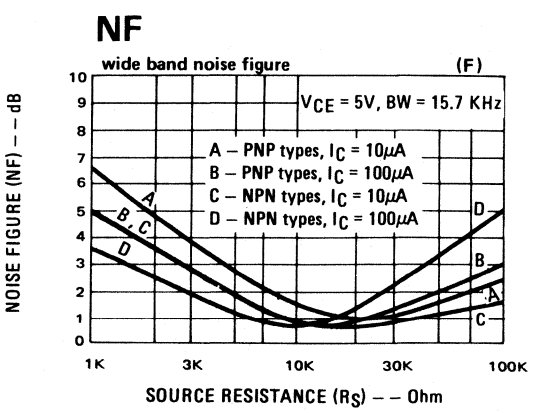
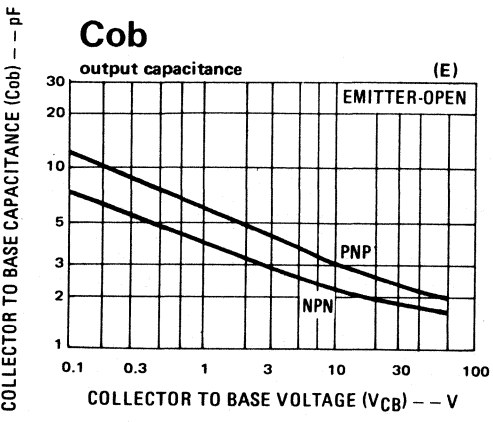
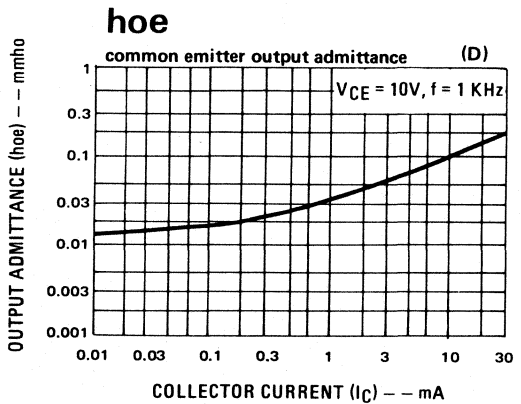
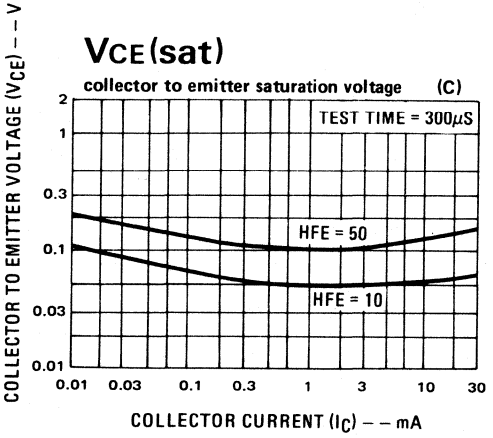
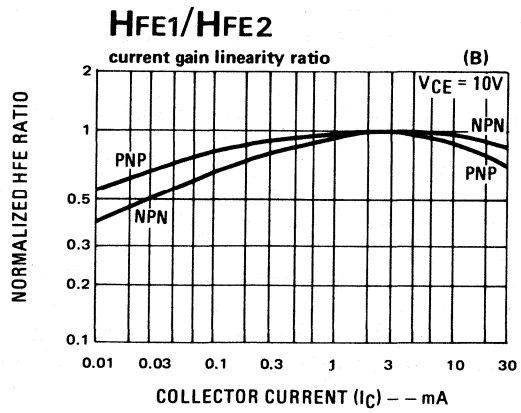
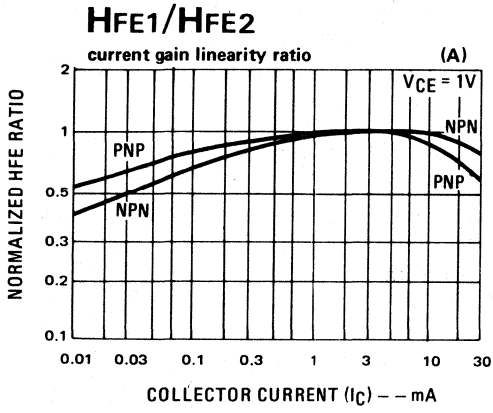



**9** typical applications

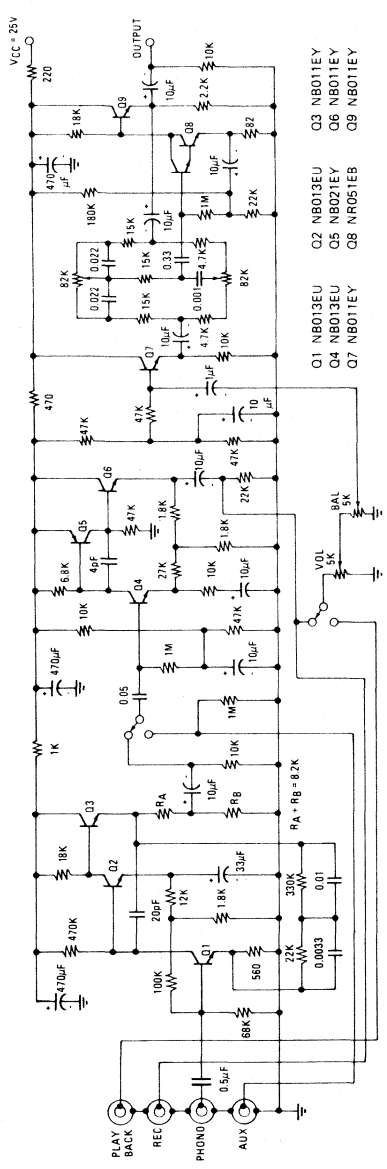

Figure A. High Quality Preamplifier with Tone Control Circuit

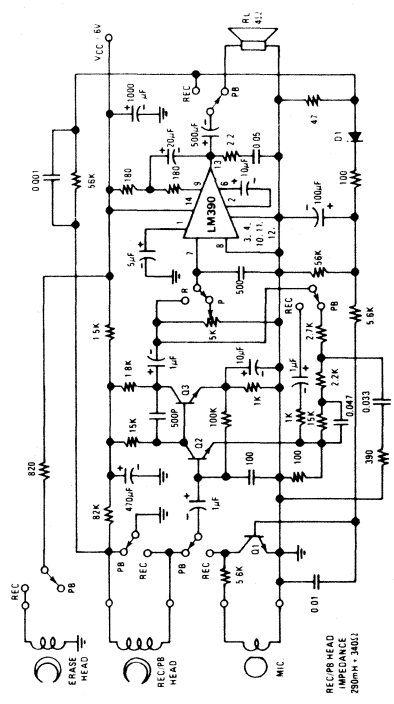

Figure B. Battery Operated Recording/Playback Cassette Circuit

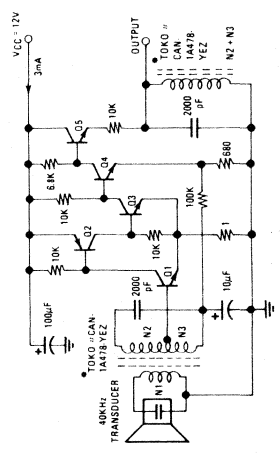

Figure C. High Gain Ultrasonic Amplifier

NB013, 014(N/PN), NB023, 024(PNP)





**NB111,112,113 (NPN) 100mA general purpose transistors**  
**NB121,122,123 (PNP)**

**features**

- 35 to 65 Volt at 100mA collector ratings
- 300mV guaranteed  $V_{CE}$  (sat) characteristics at  $I_C = 40mA$  and  $I_B = 0.8mA$
- Matched HFE groupings for complementary applications
- "Epoxy B" packaging concept for excellent reliability

**1 package and lead coding**

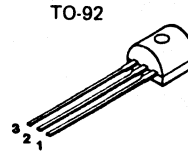

**applications**

- Small signal amplifier circuits
- Medium current level switching circuits
- LED drivers
- TV receivers

PACKAGE CODE TO-92	LEAD		
	1	2	3
E	E	B	C
F	E	C	B
H	C	B	E

**2 maximum ratings**

PARAMETER	SYMBOL	NB111 NB121	NB112 NB122	NB113 NB123	UNIT
Collector-Emitter Voltage	$V_{CEO}$	35	50	65	$V_{DC}$
Collector-Base Voltage	$V_{CB}$	40	55	70	$V_{DC}$
Emitter-Base Voltage	$V_{EB}$	6	6	6	$V_{DC}$
Collector Current (continuous)	$I_C$ (max)	100	100	100	$mA_{DC}$
Power Dissipation ( $T_A = 25^\circ C$ )	$P_D$	0.6	0.6	0.6	W
Power Dissipation ( $T_C = 25^\circ C$ )	$P_D$	1.0	1.0	1.0	W
Thermal Resistance	$\theta_{JA}$	208	208	208	$^\circ C/W$
	$\theta_{JC}$	125	125	125	$^\circ C/W$
Temperature, Junction and Storage	$T_j, T_{stg}$	-55 to + 150	-55 to + 150	-55 to + 150	$^\circ C$

**3 ordering information**

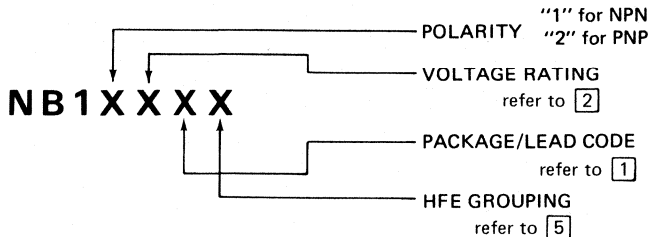

**4 electrical characteristics**  $T_C = 25^\circ\text{C}$

SYMBOL	PARAMETER	CONDITIONS	MIN	TYP	MAX	UNIT
BV <sub>CEO</sub>	Collector-Emitter Sustaining Voltage NB111/121 NB112/122 NB113/123	I <sub>C</sub> = 1 mA	35			V
			50			V
			65			V
BV <sub>CBO</sub>	Collector-Base Breakdown Voltage NB111/121 NB112/122 NB113/123	I <sub>C</sub> = 100μA	40			V
			55			V
			70			V
BV <sub>EBO</sub>	Emitter-Base Breakdown Voltage	I <sub>E</sub> = 10μA	6			V
I <sub>CEO</sub>	Collector-Emitter Leakage Current	V <sub>CE</sub> = 30V NB111/121			1	μA
		45V NB112/122			1	μA
		60V NB113/123			1	μA
I <sub>CBO</sub>	Collector-Base Leakage Current	V <sub>CB</sub> = 35V NB111/121			0.1	μA
		50V NB112/122			0.1	μA
		65V NB113/123			0.1	μA
I <sub>EBO</sub>	Emitter-Base Leakage Current	V <sub>EB</sub> = 5V			0.1	μA
V <sub>BE(sat)</sub>	Base-Emitter Saturation Voltage	I <sub>C</sub> = 40 mA, I <sub>B</sub> = 0.8 mA		0.8	0.95	V
V <sub>CE(sat)</sub>	Collector-Emitter Saturation Voltage	I <sub>C</sub> = 40 mA, I <sub>B</sub> = 0.8 mA		0.15	0.3	V
HFE1	DC Current Gain	I <sub>C</sub> = 100μA, V <sub>CE</sub> = 5V	50			ratio
C <sub>ob</sub>	Collector Output Capacitance NPN types PNP types	V <sub>CB</sub> = 10V, f = 1MHz		2		pF
				3		pF
f <sub>t</sub>	Current Gain Bandwidth Product	I <sub>C</sub> = 15 mA, V <sub>CE</sub> = 5V	100			MHz

**5 HFE groupings**

GROUPING	PARAMETER	CONDITIONS	MIN	TYP	MAX	RATIO
H	DC Current Gain	I <sub>C</sub> = 15 mA, V <sub>CE</sub> = 5V	100	127	160	1:1.6
I	DC Current Gain	I <sub>C</sub> = 15 mA, V <sub>CE</sub> = 5V	140	180	240	1:1.6
J	DC Current Gain	I <sub>C</sub> = 15 mA, V <sub>CE</sub> = 5V	200	260	350	1:1.6
Y	DC Current Gain	I <sub>C</sub> = 15 mA, V <sub>CE</sub> = 5V	100	190	350	1:3.5

**6 physical dimensions**

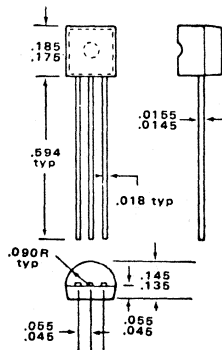

**7 max power dissipation**

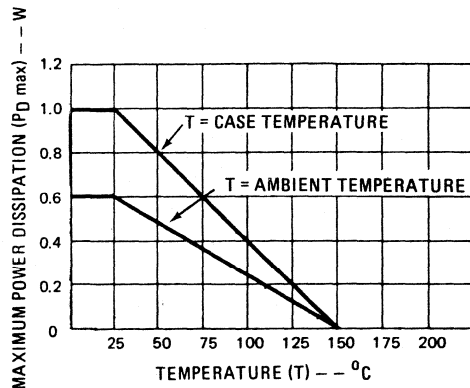

8 typical performance characteristics

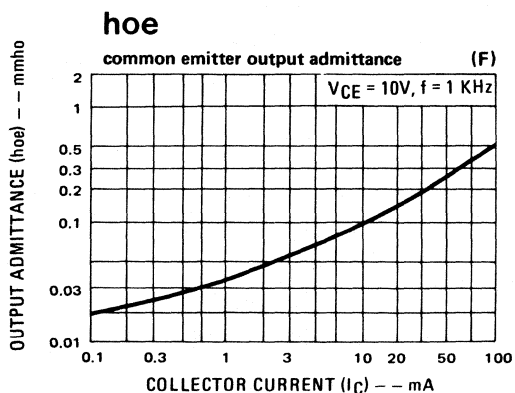
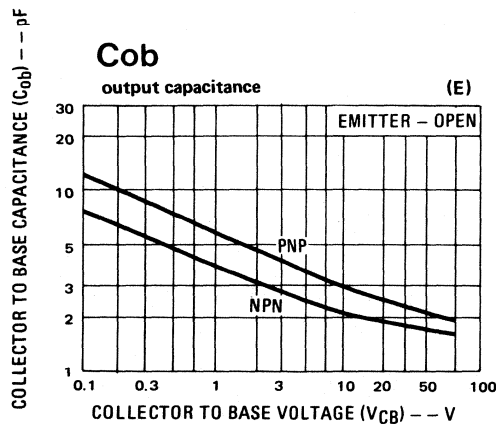
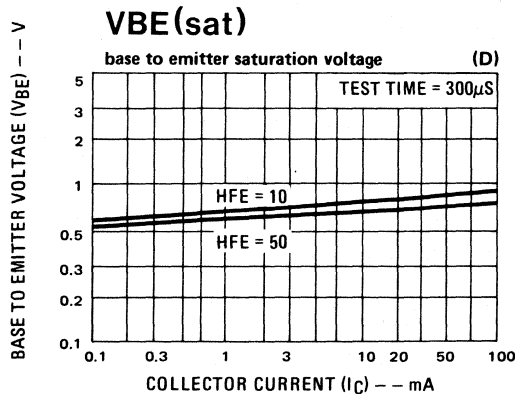
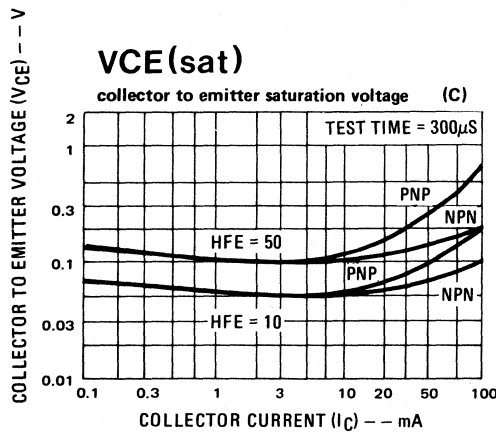
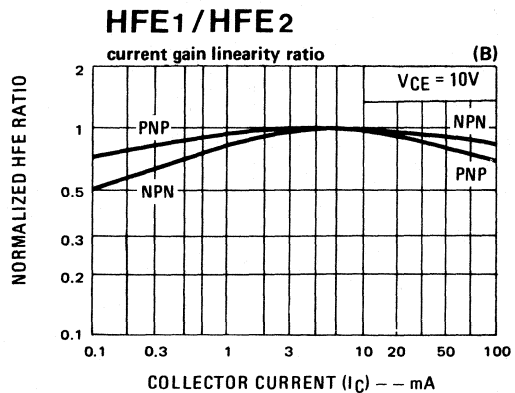
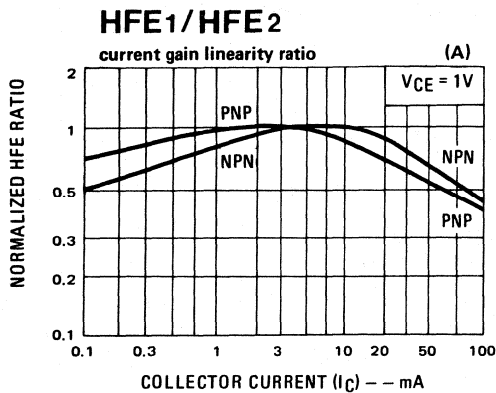

**9** typical applications

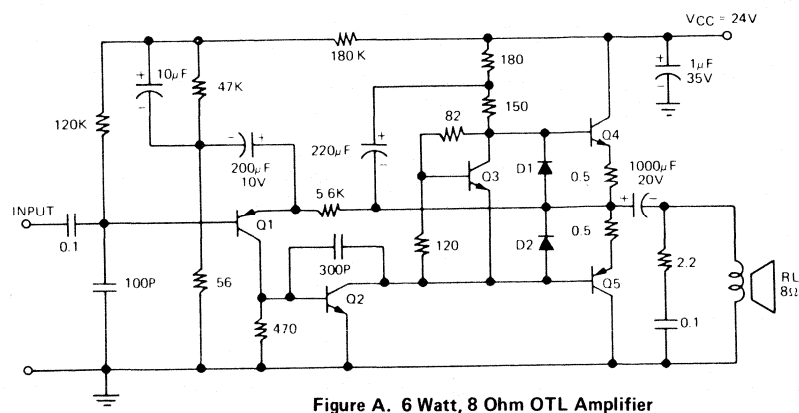

- Q1 NB021EY
- Q2 NB211YY
- Q3 NR001E
- Q4 NA41U
- Q5 NA42U

Figure A. 6 Watt, 8 Ohm OTL Amplifier

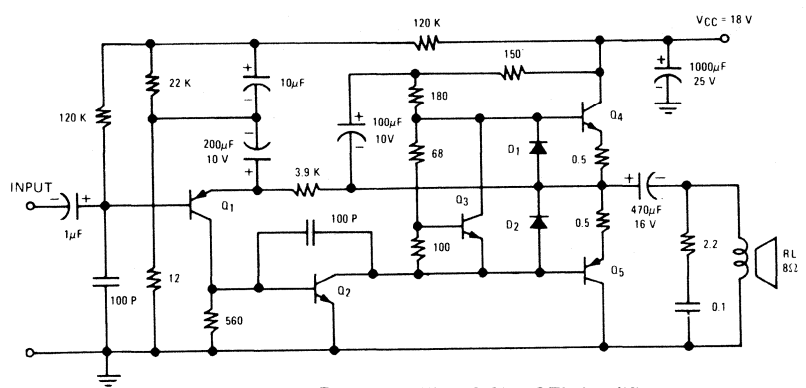

- Q1 NB021EY
- Q2 NB211EY
- Q3 NR001E
- Q4 NA31YG/I
- Q5 NA32YG/I

Figure B. 4 Watt, 8 Ohm OTL Amplifier

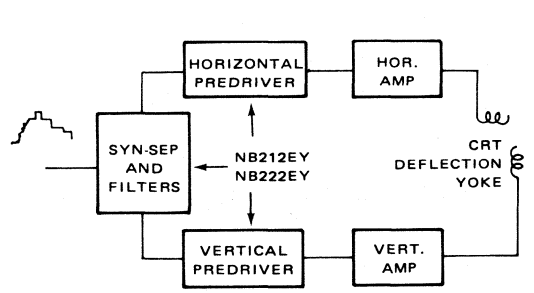

Figure C. TV processor/predriver applications

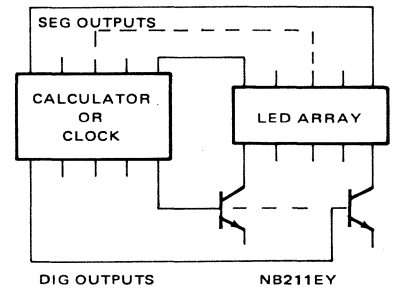

Figure D. Calculator/Clock driver application

NB111, 112, 113(NPN), NB121, 122, 123(PNP)



**NB 211, 212, 213 (NPN)  
NB 221, 222, 223 (PNP) 500mA medium current driver transistors**

**features**

- 35 to 65 Volt at 500 mA collector ratings
- 1.2 Watts practical power dissipation (TO-92 PLUSTM)
- 400 mV guaranteed  $V_{CE}$  (sat) characteristics at  $I_C = 100$  mA and  $I_B = 2$  mA
- Matched HFE groupings for complementary applications
- "Epoxy B" packaging concept for excellent reliability

**1 package and lead coding**

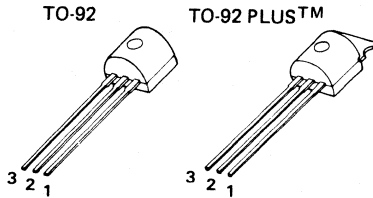

**applications**

- 4 to 6 Watt amplifier class A drivers
- Medium current level switching circuits
- LED drivers
- TV receivers

PACKAGE CODE	TO-92 PLUS	LEAD		
		1	2	3
E	X	E	B	C
F	Y	E	C	B
H	Z	B	C	E

**2 maximum ratings**

PARAMETER	SYMBOL	NB211 NB221	NB212 NB222	NB213 NB223	UNIT
Collector-Emitter Voltage	$V_{CEO}$	35	50	65	$V_{DC}$
Collector-Base Voltage	$V_{CB}$	40	55	70	$V_{DC}$
Emitter-Base Voltage	$V_{EB}$	6.0	6.0	6.0	$V_{DC}$
Collector Current (continuous)	$I_C$ (max)	500	500	500	mA
Power Dissipation ( $T_A = 25^\circ C$ )	$P_D$				
TO-92		0.6	0.6	0.6	W
TO-92 PLUS		0.75	0.75	0.75	W
Power Dissipation ( $T_C = 25^\circ C$ )	$P_D$				
TO-92		1.0	1.0	1.0	W
TO-92 PLUS		2.5	2.5	2.5	W
Thermal Resistance					
TO-92	$\theta_{JA}/\theta_{JC}$	208/125	208/125	208/125	$^\circ C/W$
TO-92 PLUS	$\theta_{JA}/\theta_{JC}$	167/50	167/50	167/50	$^\circ C/W$
Temperature, Junction and Storage	$T_j, T_{stg}$	-55 to +150	-55 to +150	-55 to +150	$^\circ C$

**3 ordering information**

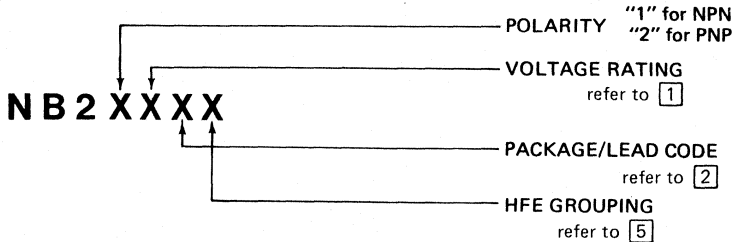

**4** electrical characteristics  $T_C = 25^\circ\text{C}$

SYMBOL	PARAMETER	CONDITIONS	MIN	TYP	MAX	UNIT
$BV_{CEO}$	Collector-Emitter Sustaining Voltage NB211/221 NB212/222 NB213/223	$I_C = 1\text{ mA}$	35 50 65			V V V
$BV_{CBO}$	Collector-Base Breakdown Voltage NB211/221 NB212/222 NB213/223	$I_C = 100\mu\text{A}$	40 55 70			V V V
$BV_{EBO}$	Emitter-Base Breakdown Voltage	$I_E = 10\mu\text{A}$	6			V
$I_{CEO}$	Collector-Emitter Leakage Current	$V_{CE} = 30\text{V}$ NB211/221 45V NB212/222 60V NB213/223			10 10 10	$\mu\text{A}$ $\mu\text{A}$ $\mu\text{A}$
$I_{CBO}$	Collector-Base Leakage Current	$V_{CB} = 35\text{V}$ NB211/221 50V NB212/222 65V NB213/223			0.5 0.5 0.5	$\mu\text{A}$ $\mu\text{A}$ $\mu\text{A}$
$I_{EBO}$	Emitter-Base Leakage Current	$V_{EB} = 5\text{V}$			0.1	$\mu\text{A}$
$V_{BE}(\text{sat})$	Base-Emitter Saturation Voltage	$I_C = 100\text{ mA}$ , $I_B = 2\text{ mA}$		0.8	0.95	V
$V_{CE}(\text{sat})$	Collector-Emitter Saturation Voltage	$I_C = 100\text{ mA}$ , $I_B = 2\text{ mA}$		0.2	0.4	V
HFE1	DC Current Gain	$I_C = 1\text{ mA}$ , $V_{CE} = 5\text{V}$	30			ratio
$C_{ob}$	Collector Output Capacitance NPN types PNP types	$V_{CB} = 10\text{V}$ , $f = 1\text{ MHz}$		3.5 4.5		pF pF
$f_t$	Current Gain Bandwidth Product	$I_C = 20\text{ mA}$ , $V_{CE} = 5\text{V}$	50			MHz

**5** HFE groupings

GROUPING	PARAMETER	CONDITIONS	MIN	TYP	MAX	RATIO
G	DC Current Gain	$I_C = 30\text{ mA}$ , $V_{CE} = 5\text{V}$	68	85	110	1:1.6
H	DC Current Gain	$I_C = 30\text{ mA}$ , $V_{CE} = 5\text{V}$	100	127	160	1:1.6
I	DC Current Gain	$I_C = 30\text{ mA}$ , $V_{CE} = 5\text{V}$	140	180	240	1:1.6
J	DC Current Gain	$I_C = 30\text{ mA}$ , $V_{CE} = 5\text{V}$	200	260	350	1:1.6
X	DC Current Gain	$I_C = 30\text{ mA}$ , $V_{CE} = 5\text{V}$	30	58	110	1:3.5
Y	DC Current Gain	$I_C = 30\text{ mA}$ , $V_{CE} = 5\text{V}$	100	190	250	1:3.5

**6** physical dimensions

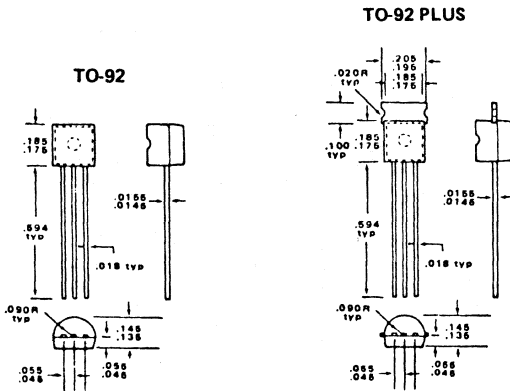

**7** heatsink information

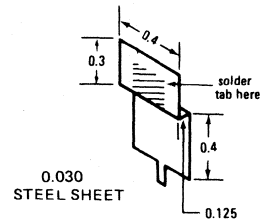

- TO-92 PLUS package with heat sink shown on right permits 1.6 Watts power dissipation and combined Thermal Resistance  $\theta_{JA} = 78^\circ\text{C/W}$ . If used without heatsink and PCB land area at collector lead  $> 1\text{ sq. inch}$ ,  $P_D = 1.2\text{W}$ .

8 typical performance characteristics

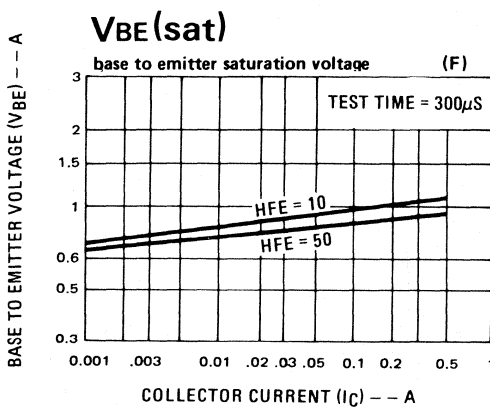
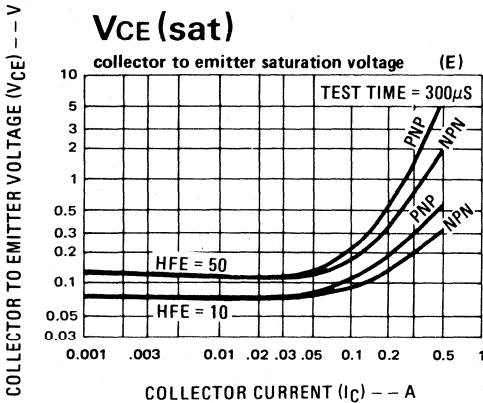
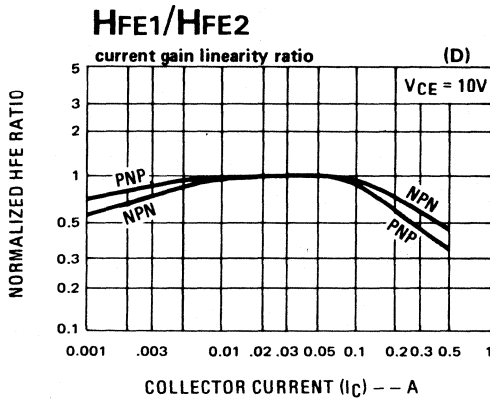
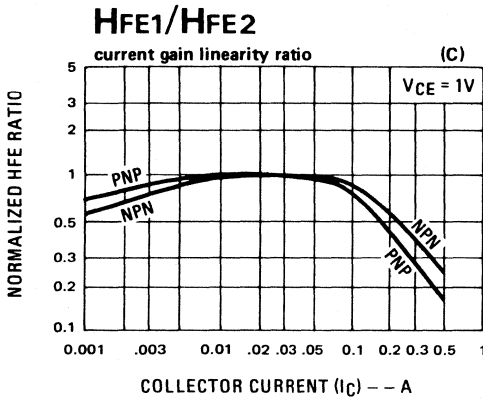
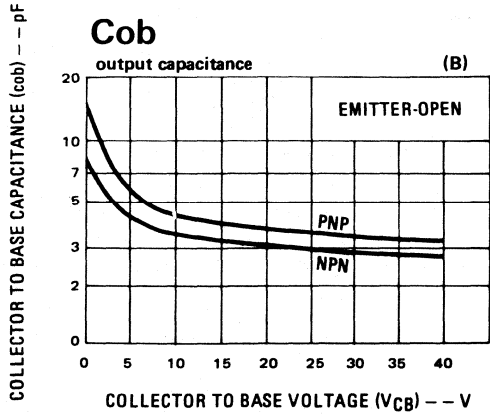
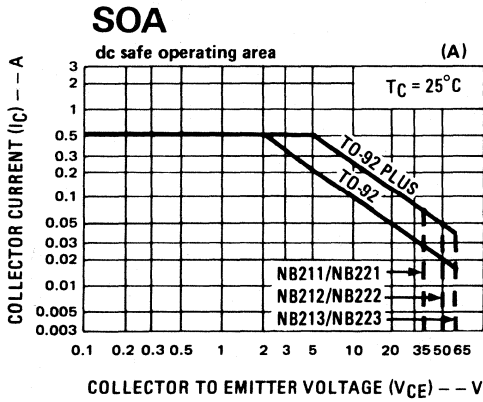



9 typical applications

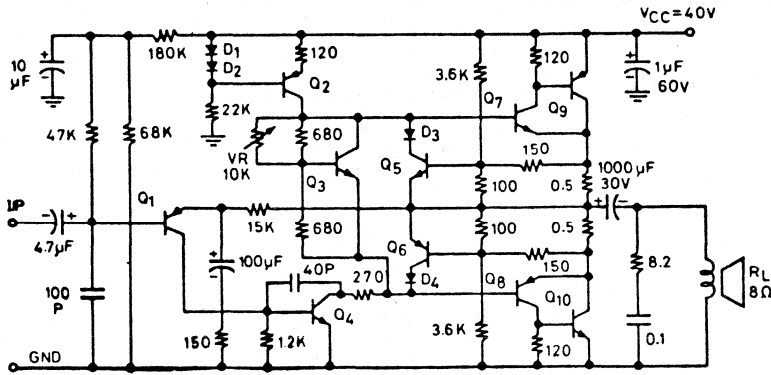

- Q1 NB022EY
- Q2 NB123EY
- Q3 NR001E
- Q4 NB113EY
- Q5 NB111EY
- Q6 NB121EY
- Q7 NB313Y
- Q8 NB323Y
- Q9 NA72W
- Q10 NA71W

Figure A. 25 Watt OTL Amplifier

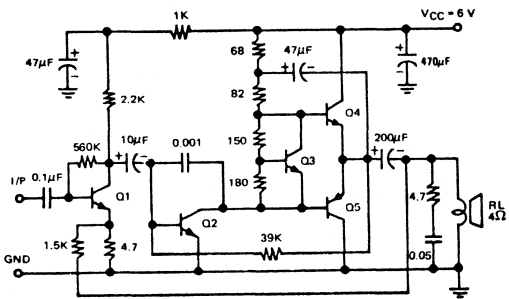
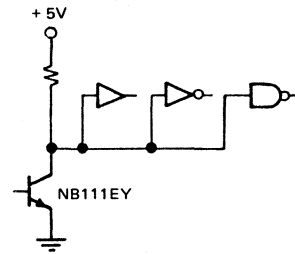

Figure B. 700mW 6V/4Ω OTL Amplifier



- Q1 NB011EY
- Q2 NB111EH/J
- Q3 NR001
- Q4 NA21EG/J
- Q5 NA22EG/J

Figure C. High fan-out TTL driver

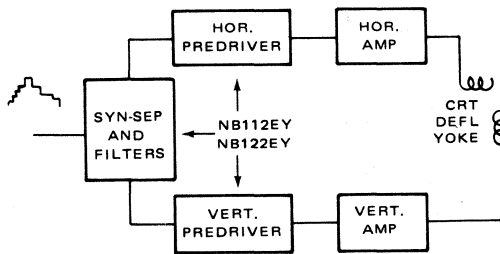

Figure D. TV processor/pre-driver applications

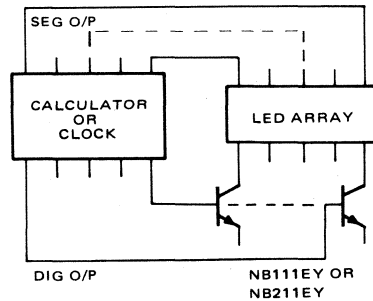

Figure E. Calculator/Clock driver application

NB211, 212, 213(NPN), NB221, 222, 223(PNP)



**NB311, 312, 313 (NPN)**  
**NB321, 322, 323 (PNP)** 1.5Amp complementary power drivers

**features**

- 35 to 65 Volt at 1.5 Amp collector ratings
- Low  $V_{CE(sat)}$  and  $V_{BE(sat)}$  characteristics with  $I_C = 300\text{ mA}$  and  $I_B = 10\text{ mA}$  drive
- Available in TO-92, TO-92 PLUS<sup>TM</sup> and TO-202 packages
- "Epoxy B" packaging concept for excellent reliability

**1 packages and lead coding**

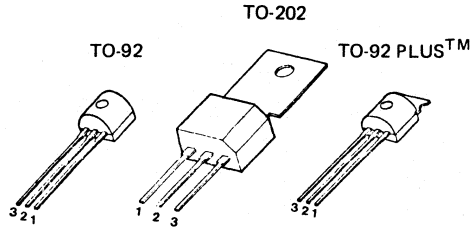

**applications**

- Driver stages in high-power audio amplifiers
- Medium-power switching circuits
- Converter/inverter circuits
- TV receivers

PACKAGE CODE			LEAD		
TO-92	TO-92 PLUS	TO-202	1	2	3
E	X	K	E	B	C
F	Y	L	E	C	B
H	Z	M	B	C	E
			C	B	E

**2 maximum ratings**

PARAMETER	SYMBOL	NB311 NB321	NB312 NB322	NB313 NB323	UNIT
Collector-Emitter Voltage	$V_{CEO}$	35	50	65	$V_{DC}$
Collector-Base Voltage	$V_{CB}$	40	55	70	$V_{DC}$
Emitter-Base Voltage	$V_{EB}$	6	6	6	$V_{DC}$
Collector Current (continuous)	$I_C$	1.5	1.5	1.5	$A_{DC}$
Power Dissipation ( $T_A = 25^\circ C$ )	$P_D$				
TO-92		0.6	0.6	0.6	W
TO-92 PLUS		0.75	0.75	0.75	W
TO-202		1.75	1.75	1.75	W
Power Dissipation ( $T_C = 25^\circ C$ )	$P_D$				
TO-92		1.0	1.0	1.0	W
TO-92 PLUS		2.5	2.5	2.5	W
TO-202		10	10	10	W
Temperature, Junction and Storage	$T_j, T_{stg}$	-55 to +150	-55 to +150	-55 to +150	$^\circ C$

**3 ordering information**

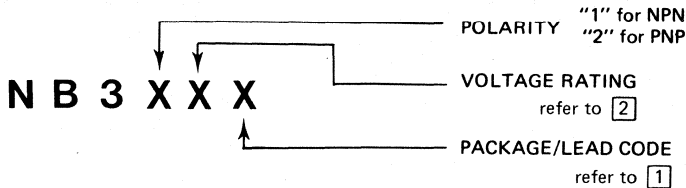

**4 electrical characteristics**  $T_c = 25^\circ\text{C}$

SYMBOL	PARAMETER	CONDITIONS	MIN	TYP	MAX	UNIT
$V_{CEO}$	Collector-Emitter Sustaining Voltage NB311/321 NB312/322 NB313/323	$I_C = 1 \text{ mA}$				
			35		V	
			50		V	
			65		V	
$V_{CBO}$	Collector-Base Breakdown Voltage NB311/321 NB312/322 NB313/323	$I_C = 100 \mu\text{A}$				
			40		V	
			55		V	
			70		V	
$V_{EBO}$	Emitter-Base Breakdown Voltage	$I_E = 10 \mu\text{A}$	6			V
$I_{CEO}$	Collector-Emitter Leakage Current	$V_{CE} = 30\text{V}$ NB311/321			50	$\mu\text{A}$
		$45\text{V}$ NB312/322			50	$\mu\text{A}$
		$60\text{V}$ NB313/323			50	$\mu\text{A}$
$I_{CBO}$	Collector-Base Leakage Current	$V_{CB} = 35\text{V}$ NB311/321			0.5	$\mu\text{A}$
		$50\text{V}$ NB312/322			0.5	$\mu\text{A}$
		$65\text{V}$ NB313/323			0.5	$\mu\text{A}$
$I_{EBO}$	Emitter-Base Leakage Current	$V_{EB} = 5\text{V}$			0.5	$\mu\text{A}$
$V_{BE(sat)}$	Base-Emitter Saturation Voltage	$I_C = 300 \text{ mA}, I_B = 10 \text{ mA}$		0.9	1	V
$V_{CE(sat)}$	Collector-Emitter Saturation Voltage	$I_C = 300 \text{ mA}, I_B = 10 \text{ mA}$		0.15	0.5	V
$HFE_1$	DC Current Gain	$I_C = 1 \text{ mA}, V_{CE} = 10\text{V}$	30			
$HFE_2$	DC Current Gain	$I_C = 100 \text{ mA}, V_{CE} = 10\text{V}$	50			
$C_{ob}$	Collector Output Capacitance NPN types PNP types	$V_{CB} = 10\text{V}, f = 1 \text{ MHz}$		10		pF
				17		pF
$f_t$	Current Gain Bandwidth Product	$I_C = 100 \text{ mA}, V_{CE} = 10\text{V}$	20			MHz

**5 physical dimensions**

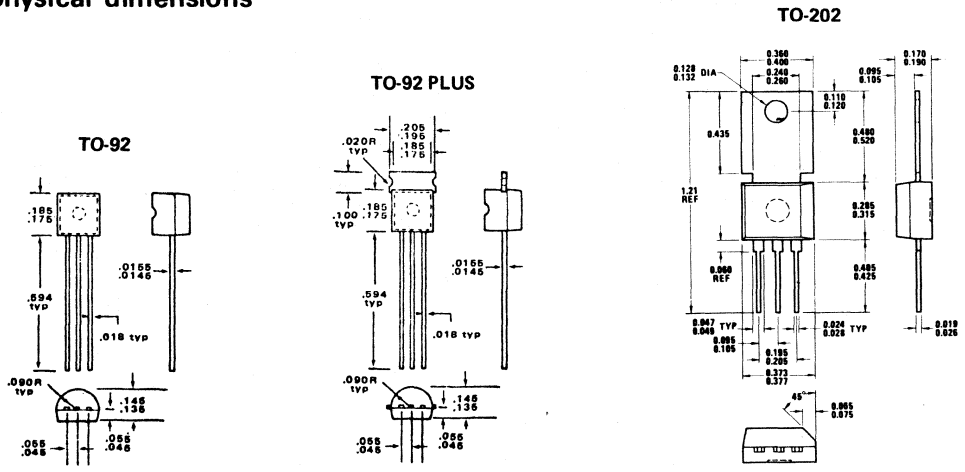

**6** typical performance characteristics

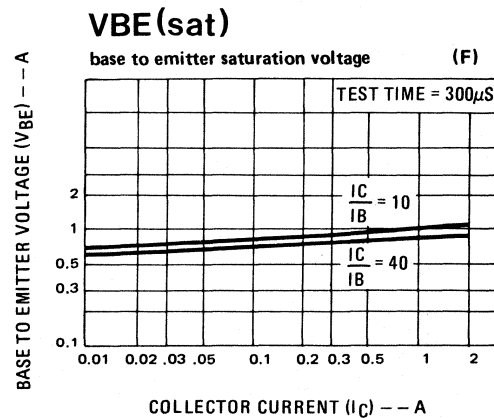
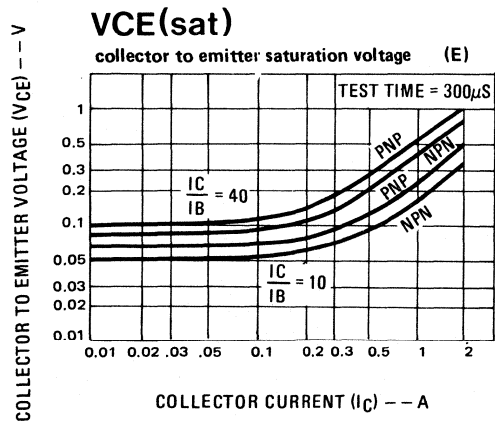
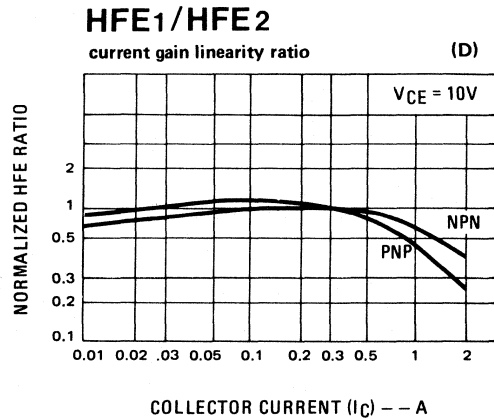
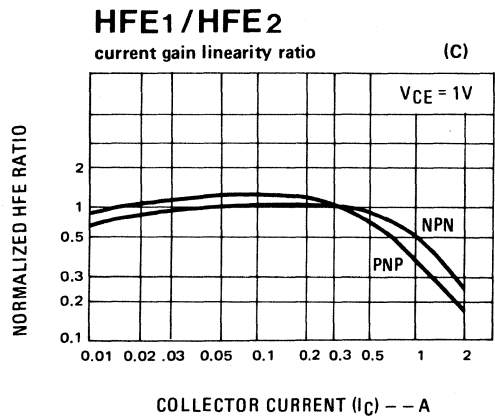
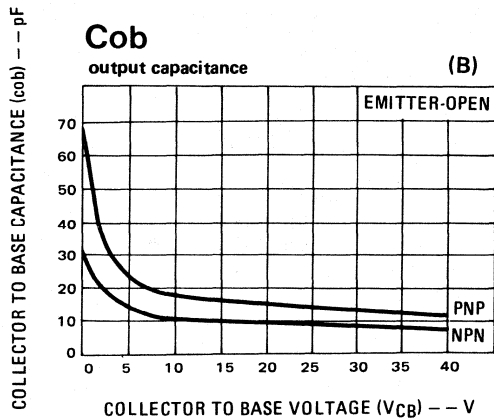
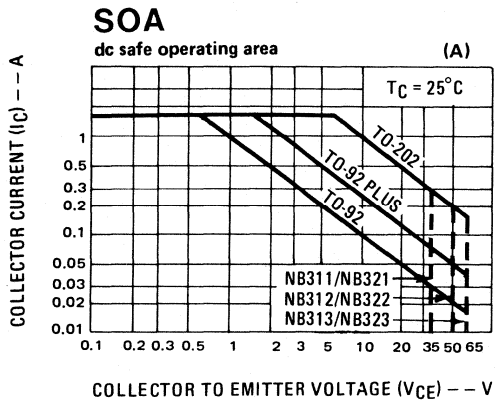

7 typical applications

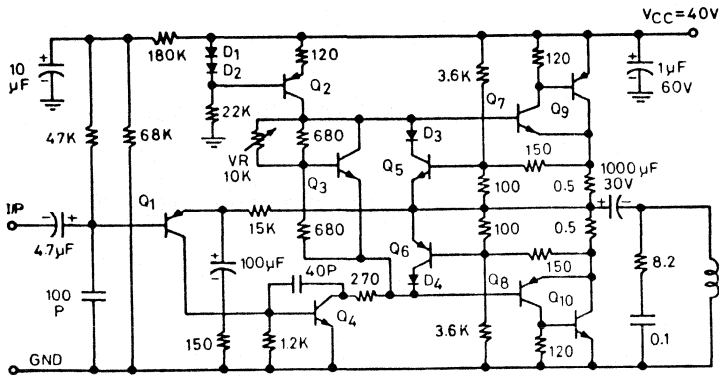

Figure A. 25 Watt OTL Amplifier

- Q1 NB022EY
- Q2 NB123EY
- Q3 NR001E
- Q4 NB113EY
- Q5 NB111EY
- Q6 NB121EY
- Q7 NB313Y
- Q8 NB323Y
- Q9 NA72W
- Q10 NA71W

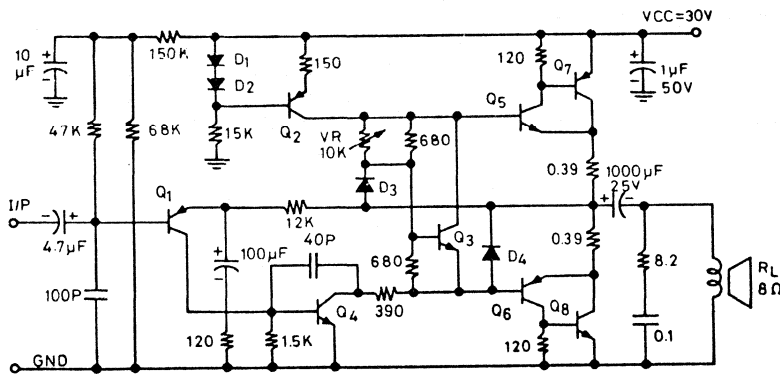

Figure B. 12 Watt OTL Amplifier

- Q1 NB021EY
- Q2 NB122EY
- Q3 NR001E
- Q4 NB112EY
- Q5 NB312E
- Q6 NB322E
- Q7 NA52W
- Q8 NA51W

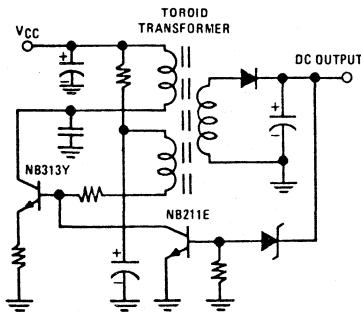

Figure C. Typical Converter Circuit

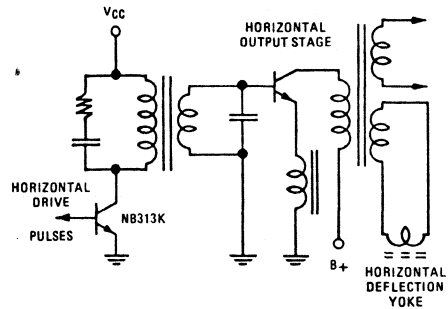

Figure D. Typical TV Horizontal Driver Application

NB311, 312, 313(NPN), NB321, 322, 323(PNP)

## NR421(NPN) VHF amplifier/FM converter transistor

### features

- 0.65pF typical feedback capacitance for excellent RF stability
- Guaranteed collector-base time constant and RF output resistance
- 150mV typical  $V_{CE}$  (sat) characteristics at  $I_C = 10$  mA, and  $I_B = 0.5$  mA
- 2 dB typical noise figure at 200 MHz
- "Epoxy B" packaging concept for excellent reliability

### 1 package and lead coding

TO-92

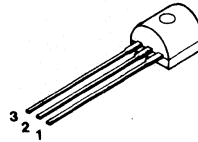

### applications

- VHF RF amplifiers/converters
- CB radios
- Low-power RF oscillators

PACKAGE CODE TO-92	LEAD		
	1	2	3
D	B	E	C
F	E	C	B

### 2 maximum ratings

PARAMETER	SYMBOL	RATING	UNIT
Collector-Emitter Voltage	$V_{CEO}$	30	$V_{DC}$
Collector-Base Voltage	$V_{CB}$	35	$V_{DC}$
Emitter-Base Voltage	$V_{EB}$	3	$V_{DC}$
Collector Current (continuous)	$I_C$ (max)	30	$mA_{DC}$
Power Dissipation ( $T_A = 25^\circ C$ )	$P_D$	0.6	W
Power Dissipation ( $T_C = 25^\circ C$ )	$P_D$	1.0	W
Thermal Resistance	$\theta_{JA}$	208	$^\circ C/W$
	$\theta_{JC}$	125	$^\circ C/W$
Temperature, Junction and Storage	$T_j, T_{stg}$	-55 to + 150	$^\circ C$

### 3 ordering information

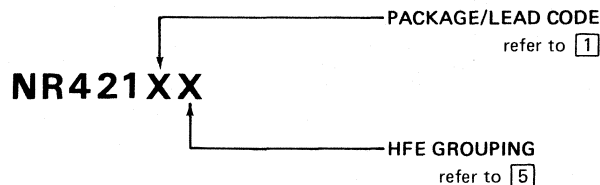

**4 electrical characteristics**  $T_C = 25^\circ\text{C}$

SYMBOL	PARAMETER	CONDITIONS	MIN	TYP	MAX	UNIT
$BV_{CEO}$	Collector-Emitter Sustaining Voltage	$I_C = 1\text{ mA}$	30			V
$BV_{CBO}$	Collector-Base Breakdown Voltage	$I_C = 100\mu\text{A}$	35			V
$BV_{EBO}$	Emitter-Base Breakdown Voltage	$I_E = 10\mu\text{A}$	3	5.5		V
$I_{CBO}$	Collector-Base Leakage Current	$V_{CB} = 30\text{V}$			0.1	$\mu\text{A}$
$V_{BE}(\text{sat})$	Base-Emitter Saturation Voltage	$I_C = 10\text{ mA}, I_B = 0.5\text{ mA}$		830	950	mV
$V_{CE}(\text{sat})$	Collector-Emitter Saturation Voltage	$I_C = 10\text{ mA}, I_B = 0.5\text{ mA}$		150	300	mV
$C_{cb}$	Common Emitter Collector Feedback Capacitance	$V_{CB} = 10\text{V}, f = 1\text{ MHz}$		0.65	0.9	pF
$C_{ob}$	Collector Output Capacitance	$V_{CB} = 10\text{V}, f = 1\text{ MHz}$		0.9	1.3	pF
$rb'Cc$	Collector Base Time Constant	$I_C = 2\text{ mA}, V_{CE} = 5\text{V}$		8	20	pS
$R_{oep}$	Common Emitter Output Resistance	$I_C = 2\text{ mA}, V_{CE} = 5\text{V}$ $f = 200\text{ MHz}$	5			KOhm
$f_t$	Current Gain Bandwidth Product	$I_C = 2\text{ mA}, V_{CE} = 5\text{V}$	450	700		MHz

**5 HFE groupings**

GROUPING	PARAMETER	CONDITIONS	MIN	TYP	MAX	RATIO
E	DC Current Gain	$I_C = 2\text{ mA}, V_{CE} = 5\text{V}$	30	38	50	1:1.6
F	DC Current Gain	$I_C = 2\text{ mA}, V_{CE} = 5\text{V}$	45	58	75	1:1.6
G	DC Current Gain	$I_C = 2\text{ mA}, V_{CE} = 5\text{V}$	68	85	110	1:1.6
H	DC Current Gain	$I_C = 2\text{ mA}, V_{CE} = 5\text{V}$	100	127	160	1:1.6
R	DC Current Gain	$I_C = 2\text{ mA}, V_{CE} = 5\text{V}$	20	32	50	1:2.4
S	DC Current Gain	$I_C = 2\text{ mA}, V_{CE} = 5\text{V}$	45	70	110	1:2.4
T	DC Current Gain	$I_C = 2\text{ mA}, V_{CE} = 5\text{V}$	100	150	240	1:2.4

**6 physical dimensions**

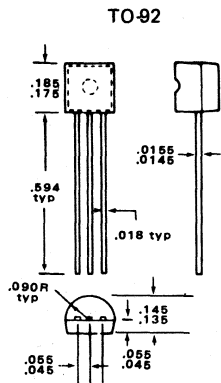

**7 max power dissipation**

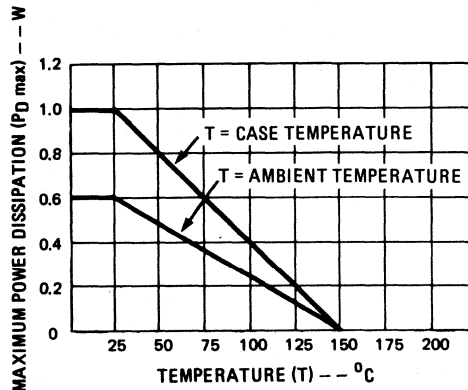

8 typical performance characteristics

**HFE1/HFE2**

current linearity ratio

(A)

NORMALIZED HFE RATIO

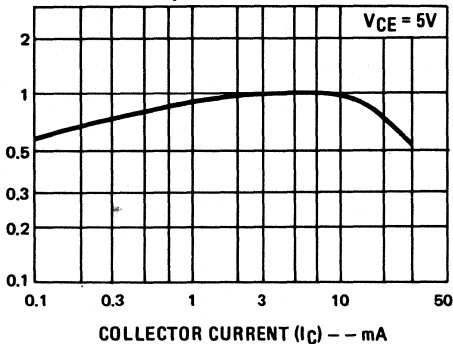

**$V_{CE(sat)}/V_{BE(on)}$**

collector/base to emitter voltage

(B)

COLLECTOR/BASE TO EMITTER VOLTAGE ( $V_{CE}/V_{BE}$ ) - - V

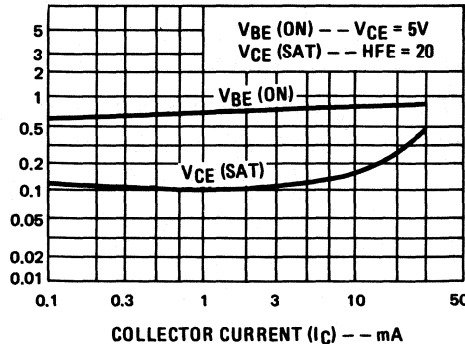

**$Y_{ie}$**

common emitter input admittance

(C)

INPUT SUSCEPTANCE ( $Y_{ie}$ ) - - mmho

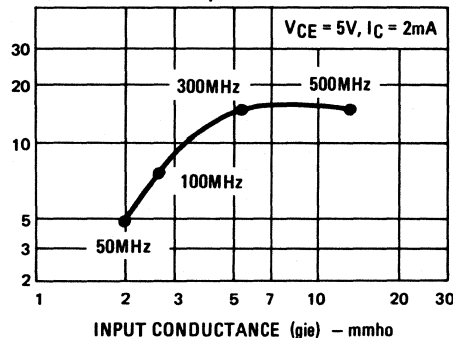

**$Y_{oe}$**

common emitter output admittance

(D)

OUTPUT SUSCEPTANCE ( $Y_{oe}$ ) - - mmho

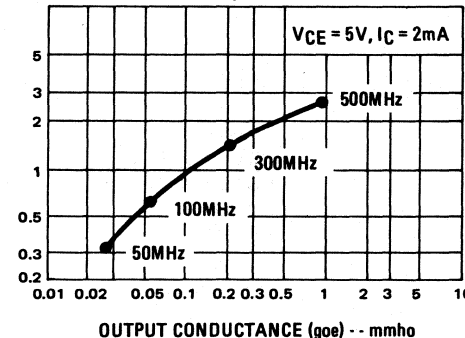

**$Y_{fe}$**

common emitter forward transfer admittance

(E)

FORWARD TRANSFER SUSCEPTANCE ( $-Y_{fe}$ ) - - mmho

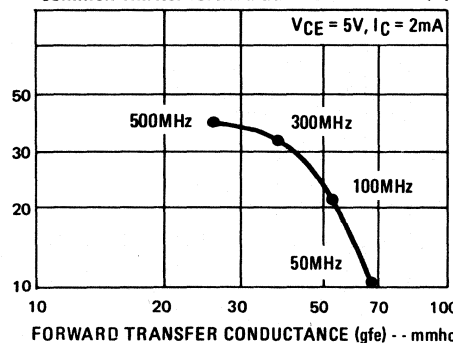

**$Y_{re}$**

common emitter reverse transfer admittance

(F)

REVERSED TRANSFER SUSCEPTANCE ( $-Y_{re}$ ) - - mmho

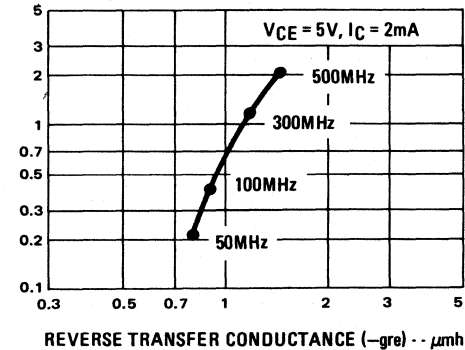





## NR431(NPN)HF amplifier/FM converter transistor

### features

- 1.1pF typical collector feedback capacitance
- 5K Ohm minimum RF output resistance at 100 MHz
- 150mV typical  $V_{CE}$  (sat) characteristics at  $I_C = 10$  mA, and  $I_B = 0.5$  mA
- "Epoxy B" packaging concept for excellent reliability

### applications

- High frequency amplifiers/converters
- CB radios
- Low power RF oscillators

### 1 package and lead coding

TO-92

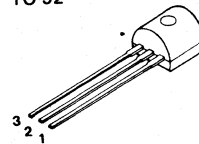

PACKAGE CODE TO-92	LEAD		
	1	2	3
E	E	B	C
F	E	C	B
H	C	B	E

### 2 maximum ratings

PARAMETER	SYMBOL	RATING	UNIT
Collector-Emitter Voltage	$V_{CEO}$	15	$V_{DC}$
Collector-Base Voltage	$V_{CB}$	18	$V_{DC}$
Emitter-Base Voltage	$V_{EB}$	3	$V_{DC}$
Collector Current (continuous)	$I_C$ (max)	30	$mA_{DC}$
Power Dissipation ( $T_A = 25^\circ C$ )	$P_D$	0.6	W
Power Dissipation ( $T_C = 25^\circ C$ )	$P_D$	1.0	W
Thermal Resistance	$\theta_{JA}$	208	$^\circ C/W$
	$\theta_{JC}$	125	$^\circ C/W$
Temperature, Junction and Storage	$T_j, T_{stg}$	-55 to + 150	$^\circ C$

### 3 ordering information

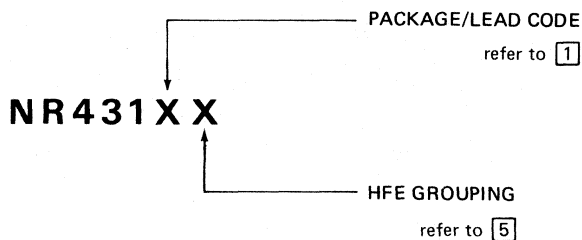

**4** electrical characteristics  $T_C = 25^\circ\text{C}$

SYMBOL	PARAMETER	CONDITIONS	MIN	TYP	MAX	UNIT
$BV_{CEO}$	Collector-Emitter Sustaining Voltage	$I_C = 1\text{ mA}$	15			V
$BV_{CBO}$	Collector-Base Breakdown Voltage	$I_C = 100\mu\text{A}$	18			V
$BV_{EBO}$	Emitter-Base Breakdown Voltage	$I_E = 10\mu\text{A}$	3	5.6		V
$I_{CBO}$	Collector-Base Leakage Current	$V_{CB} = 15\text{V}$			0.1	$\mu\text{A}$
$V_{BE}(\text{sat})$	Base-Emitter Saturation Voltage	$I_C = 10\text{ mA}, I_B = 0.5\text{ mA}$		830	950	mV
$V_{CE}(\text{sat})$	Collector-Emitter Saturation Voltage	$I_C = 10\text{ mA}, I_B = 0.5\text{ mA}$		150	300	mV
$C_{cb}$	Common Emitter Collector Feedback Capacitance	$V_{CB} = 10\text{V}, f = 1\text{ MHz}$		1.1	1.4	pF
$C_{ob}$	Collector Output Capacitance	$V_{CB} = 10\text{V}, f = 1\text{ MHz}$		1.4	1.7	pF
$R_{oop}$	Common Emitter Output Resistance	$I_C = 1\text{ mA}, V_{CE} = 5\text{V}$ $f = 100\text{ MHz}$	5			KOhm
$f_t$	Current Gain Bandwidth Product	$I_C = 1\text{ mA}, V_{CE} = 5\text{V}$	350	600		MHz

**5** HFE groupings

GROUPING	PARAMETER	CONDITIONS	MIN	TYP	MAX	RATIO
E	DC Current Gain	$I_C = 1\text{ mA}, V_{CE} = 5\text{V}$	30	38	50	1:1.6
F	DC Current Gain	$I_C = 1\text{ mA}, V_{CE} = 5\text{V}$	45	58	75	1:1.6
G	DC Current Gain	$I_C = 1\text{ mA}, V_{CE} = 5\text{V}$	68	85	110	1:1.6
R	DC Current Gain	$I_C = 1\text{ mA}, V_{CE} = 5\text{V}$	20	32	50	1:2.4
S	DC Current Gain	$I_C = 1\text{ mA}, V_{CE} = 5\text{V}$	45	70	110	1:2.4

**6** physical dimensions

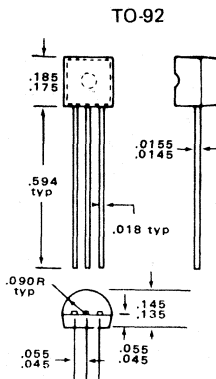

**7** max power dissipation

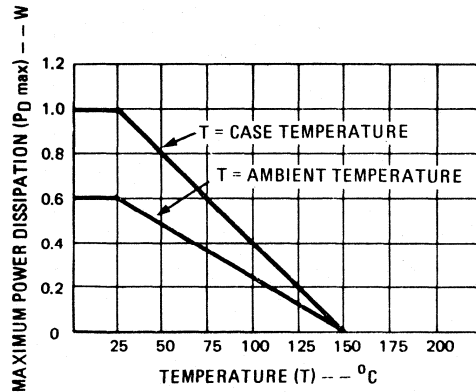

## 8 typical performance characteristics

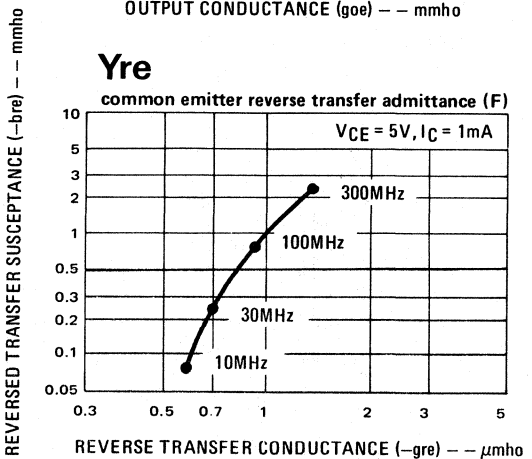
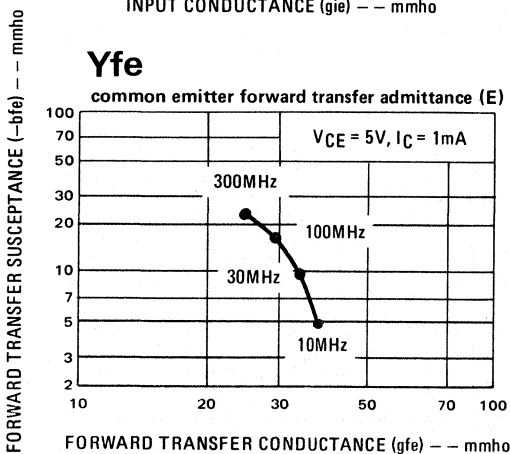
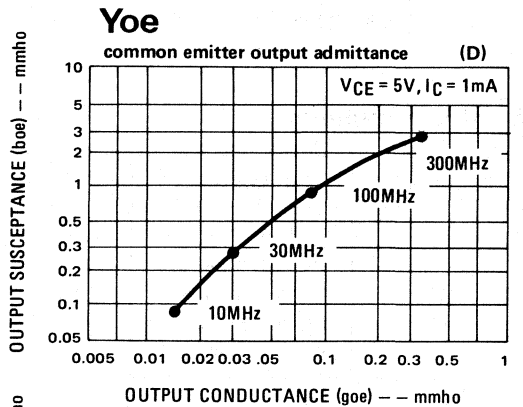
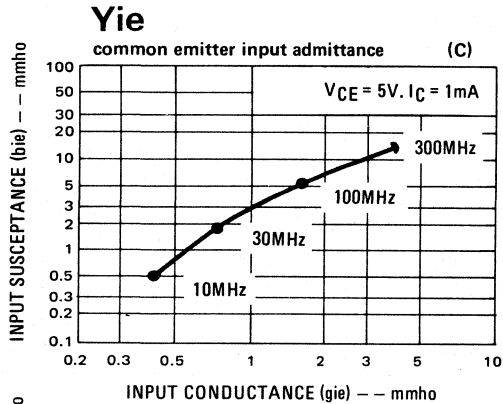
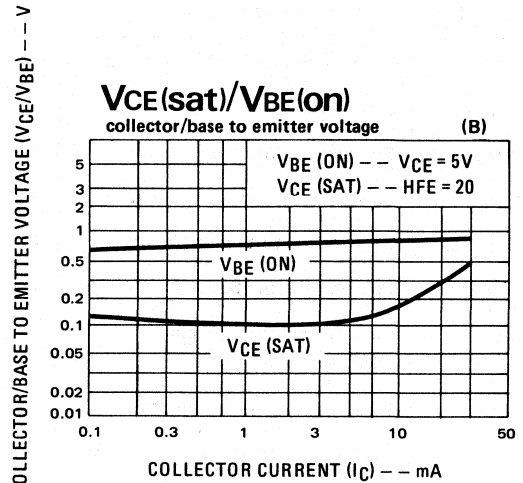
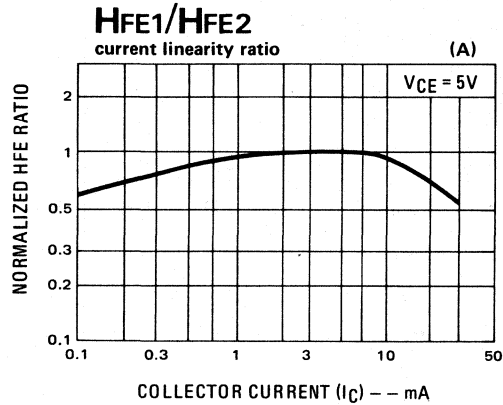

# 9 typical applications

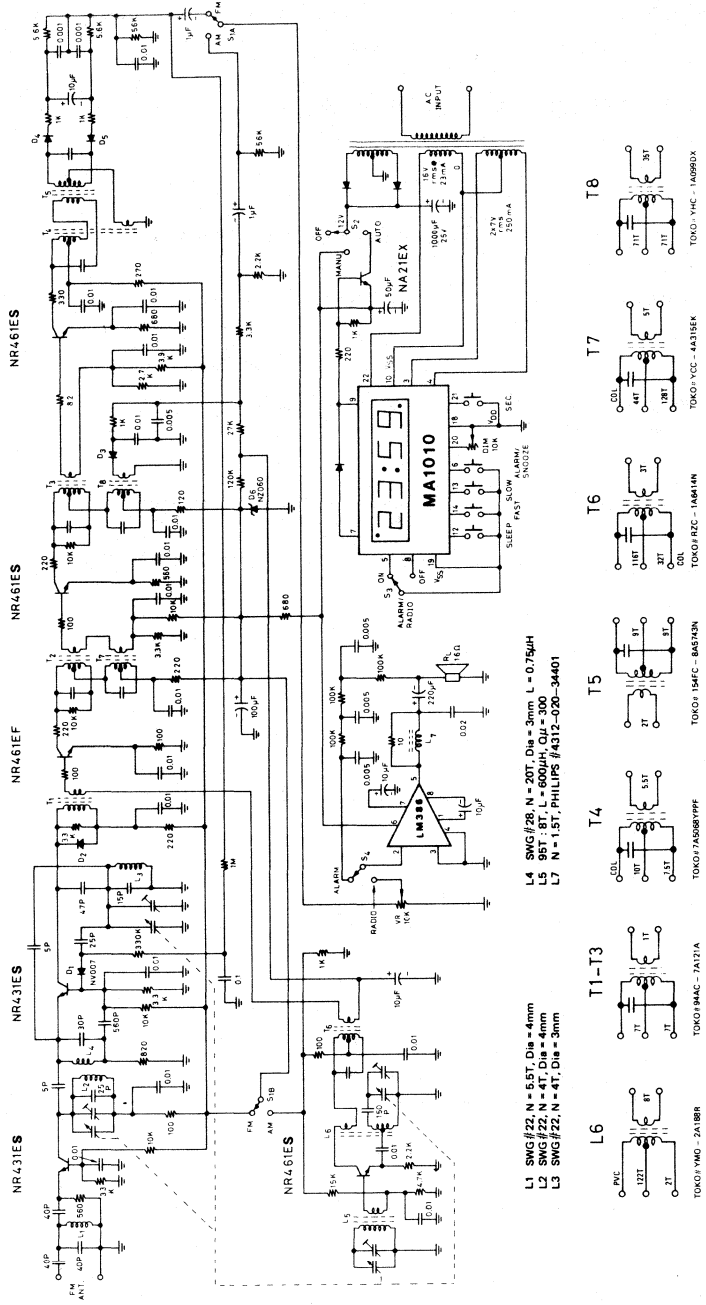

**FM performance (88-108 MHz)**

- 30dB quieting sensitivity: 5μV
- limiting sensitivity: 20μV
- AM rejection: 40dB
- AFC holding range: 800KHz
- Bandwidth: 180KHz

**AM performance (525-1650 KHz)**

- maximum sensitivity: 100μV/M
- 20dB quieting sensitivity: 280μV/M
- selectivity ± 10KHz: -28dB
- AGC figure of merit: 40dB
- over/oad distortion: 6%

**AUDIO performance**

- gain at 1 KHz: 200
- 10% THD output power: 900mW
- frequency response: 70Hz - 12KHz
- typical system dist: 0.8%
- alarm tone frequency: 600Hz

Figure A. AM/FM clock radio

## NR461(NPN) low-noise RF/IF transistor

### features

- Low  $C_{cb}$  for excellent RF stability
- High  $R_{oep}$  for simplified RF coupling designs
- 70mV typical  $V_{CE(sat)}$  characteristics at  $I_C = 10\text{ mA}$ , and  $I_B = 0.5\text{ mA}$
- 1.1 dB typical noise figure at 1 MHz
- "Epoxy B" packaging concept for excellent reliability

### applications

- MW/SW/CB radios
- 0.1 to 50 MHz frequency converters
- 455KHz to 10.7 MHz IF stages
- Low-power RF oscillators

### 1 package and lead coding

TO-92

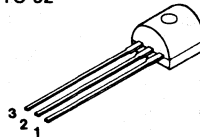

PACKAGE CODE TO-92	LEAD		
	1	2	3
E	E	B	C
F	E	C	B
H	C	B	E

### 2 maximum ratings

PARAMETER	SYMBOL	RATING	UNIT
Collector-Emitter Voltage	$V_{CEO}$	30	$V_{DC}$
Collector-Base Voltage	$V_{CB}$	35	$V_{DC}$
Emitter-Base Voltage	$V_{EB}$	4	$V_{DC}$
Collector Current (continuous)	$I_C(\text{max})$	30	$\text{mA}_{DC}$
Power Dissipation ( $T_A = 25^\circ\text{C}$ )	$P_D$	0.6	W
Power Dissipation ( $T_C = 25^\circ\text{C}$ )	$P_D$	1.0	W
Thermal Resistance	$\theta_{JA}$	208	$^\circ\text{C/W}$
	$\theta_{JC}$	125	$^\circ\text{C/W}$
Temperature, Junction and Storage	$T_j, T_{stg}$	-55 to +150	$^\circ\text{C}$

### 3 ordering information

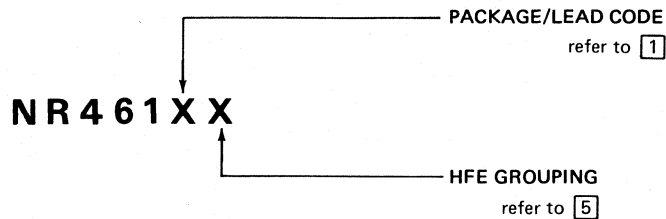

**4 electrical characteristics**  $T_C = 25^\circ\text{C}$

SYMBOL	PARAMETER	CONDITIONS	MIN	TYP	MAX	UNIT
$BV_{CEO}$	Collector-Emitter Sustaining Voltage	$I_C = 1\text{ mA}$	30			V
$BV_{CBO}$	Collector-Base Breakdown Voltage	$I_C = 100\mu\text{A}$	35			V
$BV_{EBO}$	Emitter-Base Breakdown Voltage	$I_E = 10\mu\text{A}$	4	5.5		V
$I_{CBO}$	Collector-Base Leakage Current	$V_{CB} = 30\text{V}$			0.1	$\mu\text{A}$
$V_{BE}(\text{sat})$	Base-Emitter Saturation Voltage	$I_C = 10\text{ mA}, I_B = 0.5\text{ mA}$		760	950	mV
$V_{CE}(\text{sat})$	Collector-Emitter Saturation Voltage	$I_C = 10\text{ mA}, I_B = 0.5\text{ mA}$		70	300	mV
Ccb	Common Emitter Collector Feedback Capacitance	$V_{CB} = 10\text{V}, f = 1\text{ MHz}$		0.9	1.1	pF
Roep	Common Emitter Output Resistance	$I_C = 1\text{ mA}, V_{CE} = 5\text{V}$ $f = 455\text{ KHz}$ $f = 10.7\text{ MHz}$	100 20			KOhm KOhm
ft	Current Gain Bandwidth Product	$I_C = 1\text{ mA}, V_{CE} = 5\text{V}$	180	300		MHz

**5 HFE groupings**

GROUPING	PARAMETER	CONDITIONS	MIN	TYP	MAX	RATIO
E	DC Current Gain	$I_C = 1\text{ mA}, V_{CE} = 5\text{V}$	30	38	50	1:1.6
F	DC Current Gain	$I_C = 1\text{ mA}, V_{CE} = 5\text{V}$	45	58	75	1:1.6
G	DC Current Gain	$I_C = 1\text{ mA}, V_{CE} = 5\text{V}$	68	85	110	1:1.6
H	DC Current Gain	$I_C = 1\text{ mA}, V_{CE} = 5\text{V}$	100	127	160	1:1.6
R	DC Current Gain	$I_C = 1\text{ mA}, V_{CE} = 5\text{V}$	20	32	50	1:2.4
S	DC Current Gain	$I_C = 1\text{ mA}, V_{CE} = 5\text{V}$	45	70	110	1:2.4
T	DC Current Gain	$I_C = 1\text{ mA}, V_{CE} = 5\text{V}$	100	150	240	1:2.4

**6 physical dimensions**

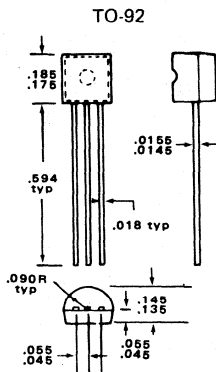

**7 max power dissipation**

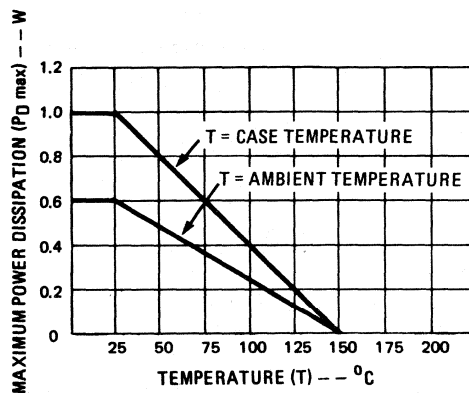

8 typical performance characteristics

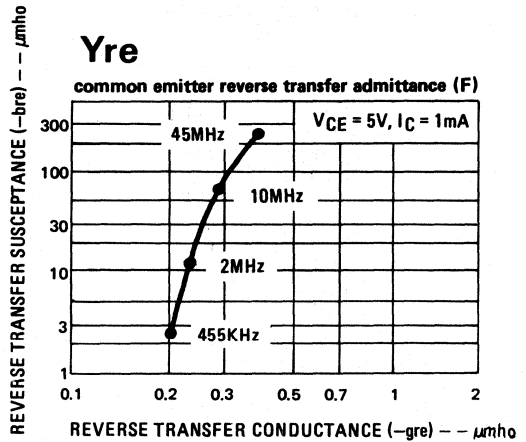
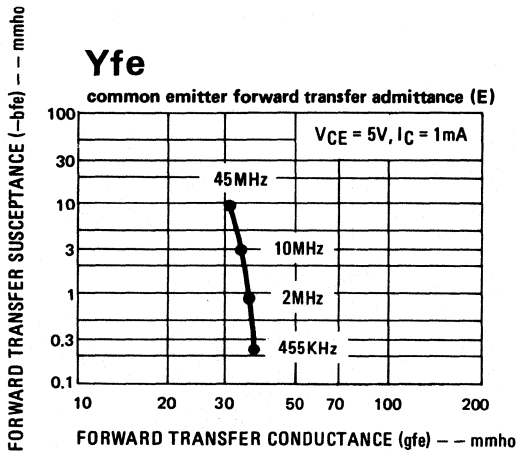
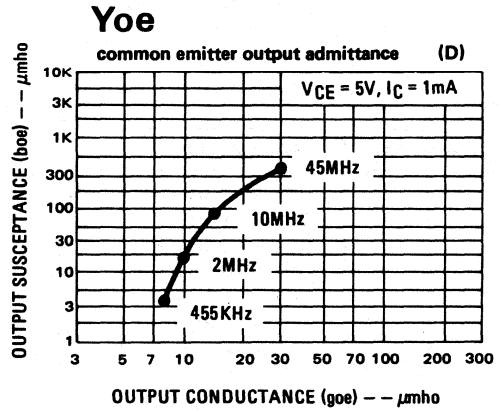
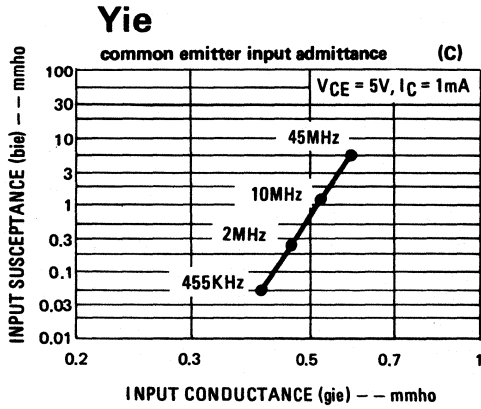
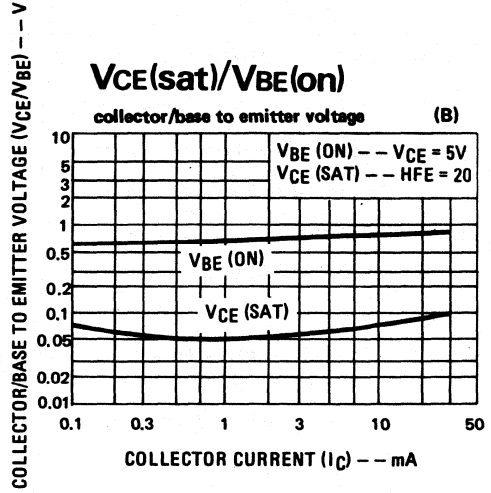
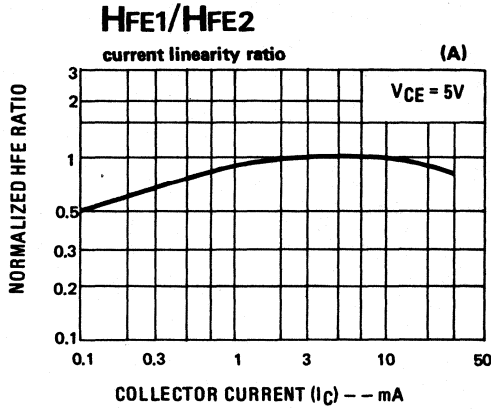



# 9 typical applications

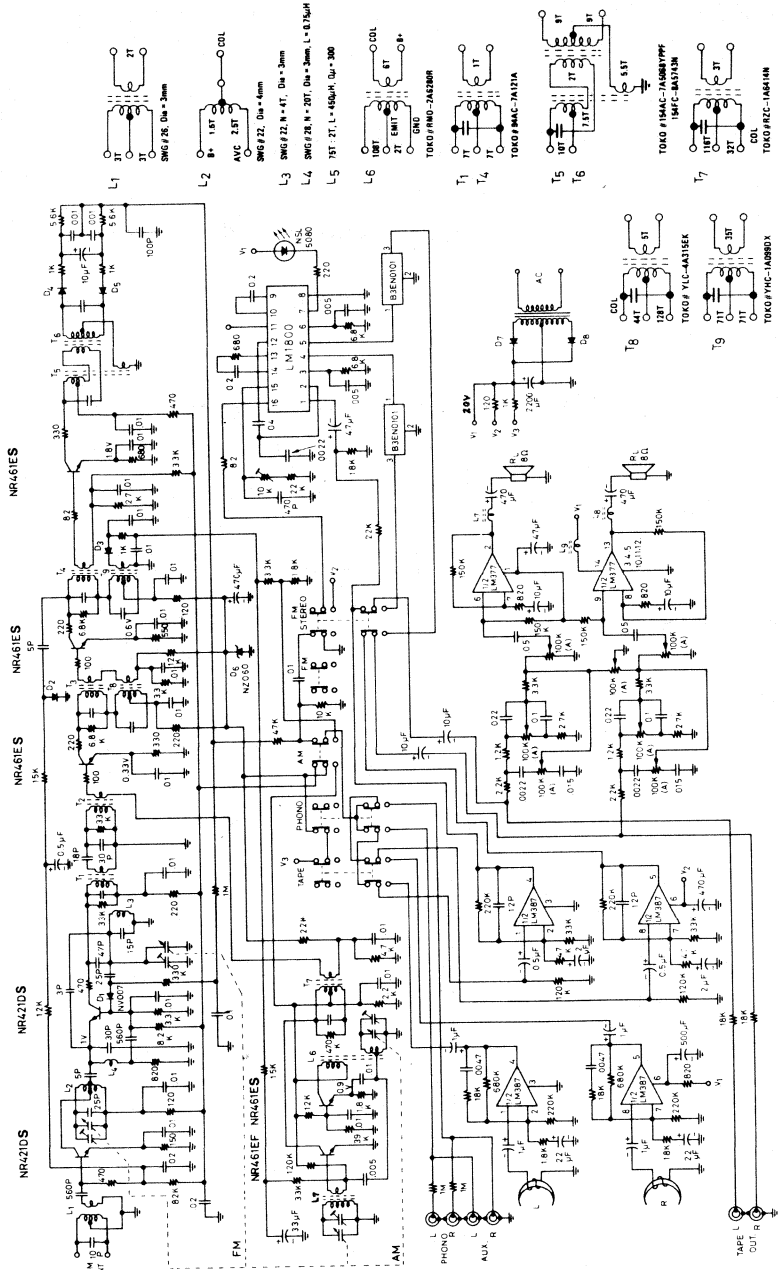

- FM performance (88-108 MHz)**
- 30dB quieting sensitivity 2μV
  - limiting sensitivity: 7μV
  - AM rejection: 40dB
  - AFC holding range: 800KHz
  - stereo separation: 40dB

- AM performance (525-1650 KHz)**
- maximum sensitivity: 100μV/M
  - 20dB quieting sensitivity: 280μV/M
  - selectivity ±10KHz: -28dB
  - AGC figure of merit: 52dB
  - overload distortion: 3%

- AUDIO performance**
- 10% THD output power: 3W + 3W
  - frequency response: 50Hz - 15KHz
  - channel separation: 45dB
  - tone control range: ±10dB
  - typical system dist: 0.5%

Figure A. AM/FM/Cassette Home Stereo Circuit

## NR041(NPN) low-level signal switching transistor

### features

- 40mV guaranteed  $V_{CE}$  (sat) characteristics at  $I_C = 1\text{mA}$  and  $I_B = 0.1\text{mA}$
- Linear collector characteristics
- 1dB typical wide-band Noise Figure
- "Epoxy B" packaging concept for excellent reliability

### applications

- ALC device for CB microphone circuits
- Cassette circuits
- Audio signal switches
- Envelope modulators for musical equipment

### 1 package and lead coding

TO-92

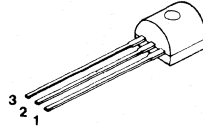

PACKAGE CODE TO-92	LEAD		
	1	2	3
E	E	B	C
F	E	C	B
H	C	B	E

### 2 maximum ratings

PARAMETER	SYMBOL	RATING	UNIT
Collector-Emitter Voltage	$V_{CEO}$	20	$V_{DC}$
Collector-Base Voltage	$V_{CB}$	20	$V_{DC}$
Emitter-Base Voltage	$V_{EB}$	5	$V_{DC}$
Collector Current (continuous)	$I_C$ (max)	30	$\text{mA}_{DC}$
Power Dissipation ( $T_A = 25^\circ\text{C}$ )	$P_D$	0.6	W
Power Dissipation ( $T_C = 25^\circ\text{C}$ )	$P_D$	1.0	W
Thermal Resistance	$\theta_{JA}$	208	$^\circ\text{C/W}$
	$\theta_{JC}$	125	$^\circ\text{C/W}$
Temperature, Junction and Storage	$T_j, T_{stg}$	- 55 to +150	$^\circ\text{C}$

### 3 ordering information

NR041X

— PACKAGE/LEAD CODE

refer to 1

**4** electrical characteristics  $T_C = 25^\circ\text{C}$

SYMBOL	PARAMETER	CONDITIONS	MIN	TYP	MAX	UNIT
$BV_{CEO}$	Collector-Emitter Sustaining Voltage	$I_C = 1\text{ mA}$	20			V
$BV_{CBO}$	Collector-Base Breakdown Voltage	$I_C = 100\mu\text{A}$	20			V
$BV_{EBO}$	Emitter-Base Breakdown Voltage	$I_E = 10\mu\text{A}$	5			V
$I_{CEO}$	Collector-Emitter Leakage Current	$V_{CE} = 15\text{ V}$			1	$\mu\text{A}$
$I_{CBO}$	Collector-Base Leakage Current	$V_{CB} = 15\text{ V}$			50	nA
$I_{EBO}$	Emitter-Base Leakage Current	$V_{EB} = 4\text{ V}$			0.1	$\mu\text{A}$
$V_{BE}(\text{sat})$	Base-Emitter Saturation Voltage	$I_C = 1\text{ mA}, I_B = 0.1\text{ mA}$		0.65	0.8	V
$V_{CE}(\text{sat})$	Collector-Emitter Saturation Voltage	$I_C = 1\text{ mA}, I_B = 0.1\text{ mA}$		25	40	mV
$C_{ob}$	Collector Output Capacitance	$V_{CB} = 10\text{ V}, f = 1\text{ MHz}$		2		pF
NF	Noise Figure	$I_C = 10\mu\text{A}, V_{CE} = 5\text{ V}$ $R_S = 10\text{ K}, BW = 15.7\text{ KHz}$		1		dB

**5** physical dimensions

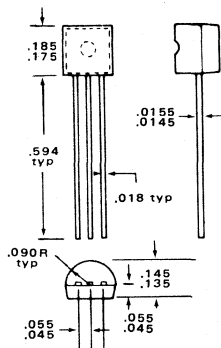

**6** max power dissipation

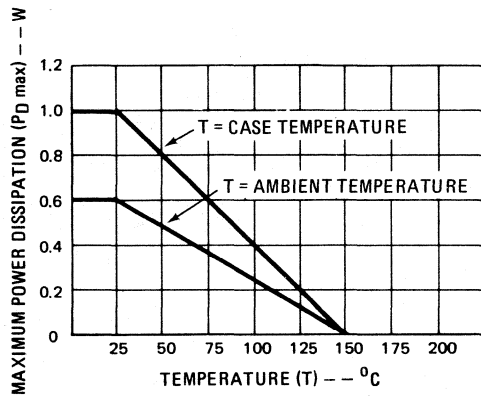

**7** typical performance characteristics

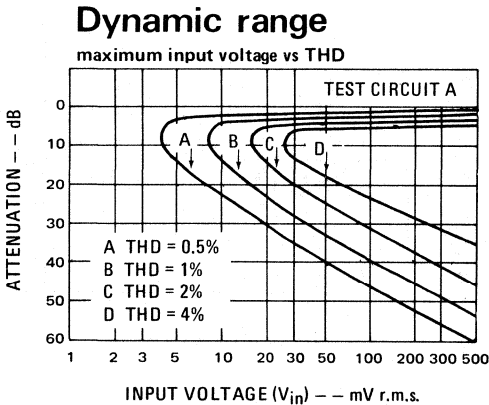
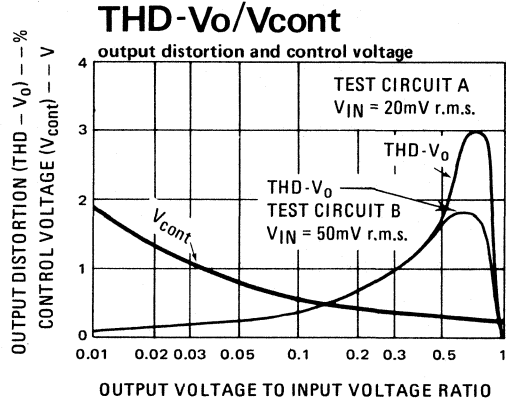
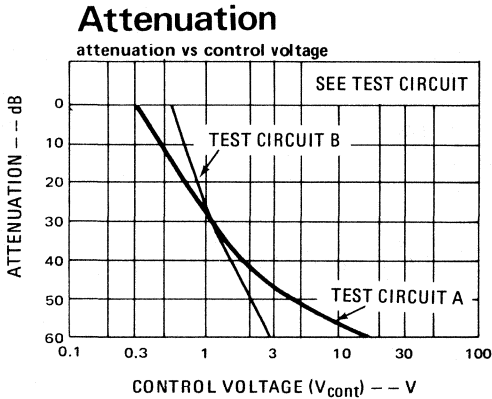
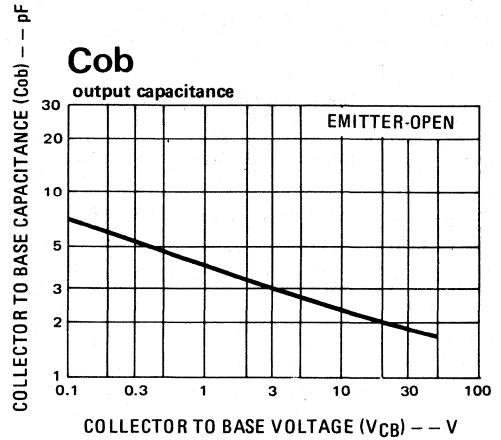
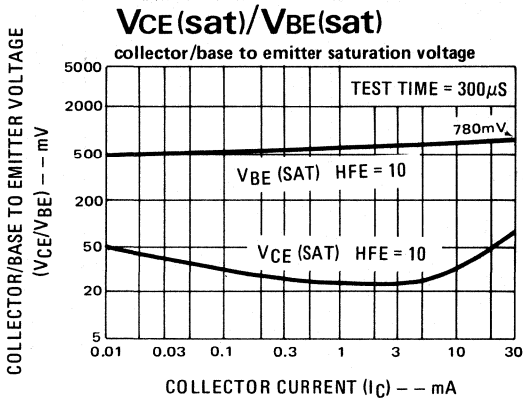

### Test circuits

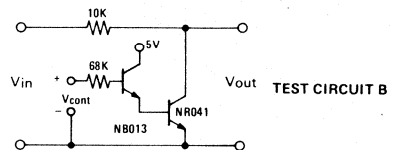
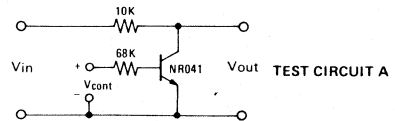

NOTE: ATTENUATION = 20 log<sub>10</sub> (V<sub>out</sub>/V<sub>in</sub>)

**8** typical applications

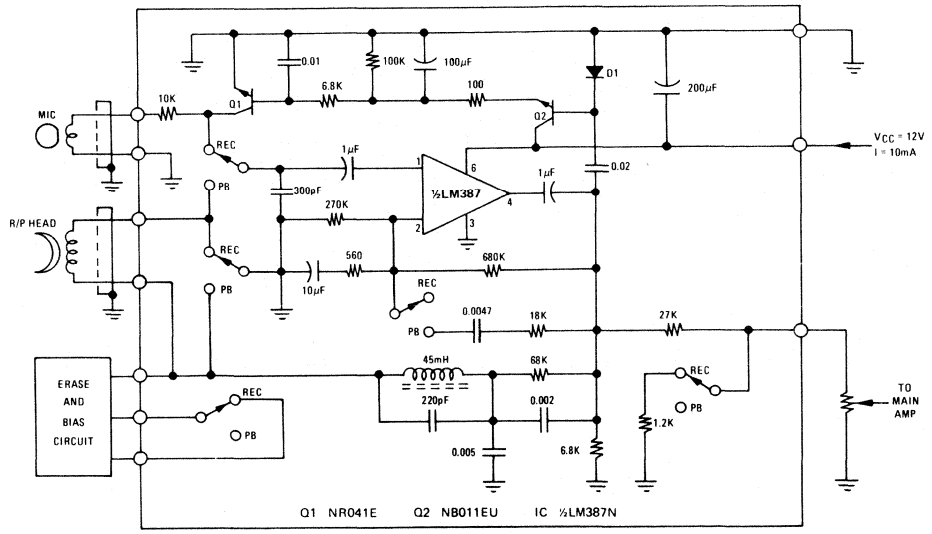

**Figure A. 60dB ALC Range Record/Playback Preamplifier**

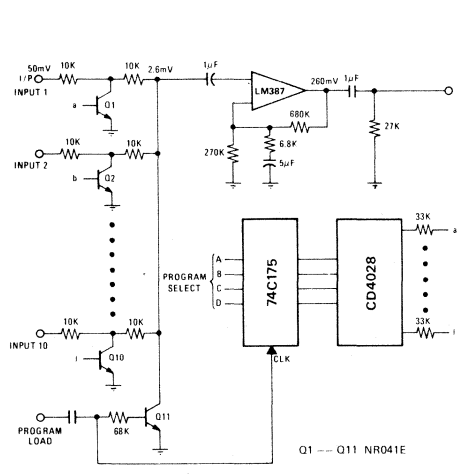

**Figure B. 10 Channel Program Selector**

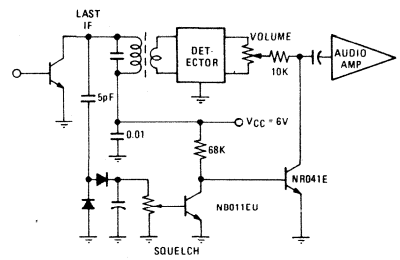

**Figure C. Squelch Circuit**

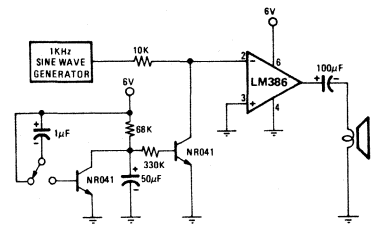

**Figure D. Ringing Tone Generator**





**Section 6**  
**Process**  
**Characteristics**  
**Double-Diffused**  
**Epitaxial Transistors**



## DESCRIPTION

Process 02 is a non-overlay double diffused, silicon device.

## APPLICATION

An economical device, good for all-around applications from DC to low radio frequencies. Ideal for use in audio, radio and television applications.

## PRINCIPAL DEVICE TYPES

TO-92: MPS-A20  
MPS-6573-6

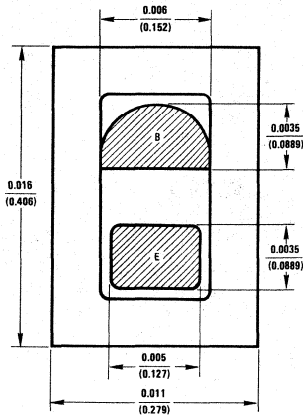

PARAMETER	CONDITIONS	MIN	TYP	MAX	UNITS
$BV_{CEO}$	$I_C = 1 \text{ mA}, I_B = 0$	40			V
$BV_{EBO}$	$I_E = 100 \mu\text{A}, I_C = 0$	4.0			V
$I_{CBO}$	$V_{CB} = 30\text{V}, I_E = 0$		100		nA
HFE	$I_C = 5 \text{ mA}, V_{CE} = 10\text{V}$	40	400		
$V_{BE(ON)}$	$I_C = 5 \text{ mA}, V_{CE} = 10\text{V}$			0.85	V
$V_{CE(SAT)}$	$I_C = 10 \text{ mA}, I_B = 1 \text{ mA}$			0.25	V
$f_t$	$I_C = 5 \text{ mA}, V_{CE} = 10\text{V}, f = 100 \text{ MHz}$	125			MHz
$C_{ob}$	$V_{CB} = 10\text{V}, I_E = 0, f = 100 \text{ kHz}$			4.0	pF



DC Current Gain vs Collector Current

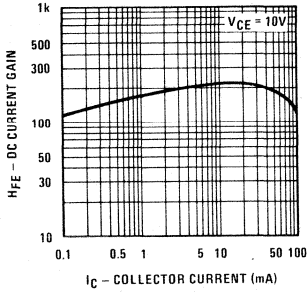

Bandwidth Product vs Collector Current

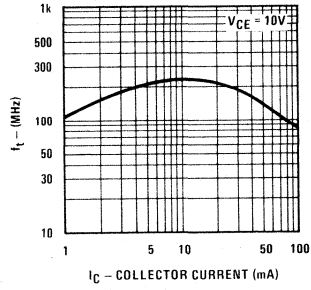

Saturation and ON Voltages

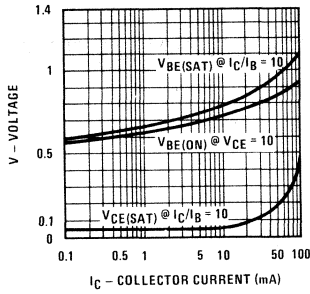

Capacitance vs Reverse Voltage

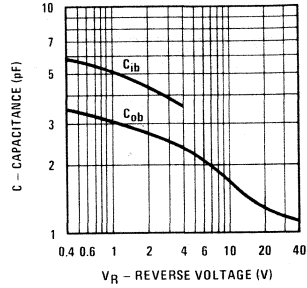

Output Admittance vs Collector Current

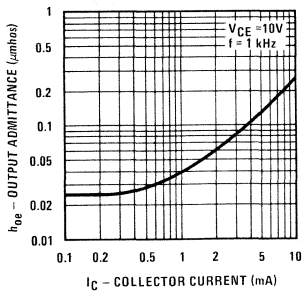

Base Spreading Resistance vs Collector Current

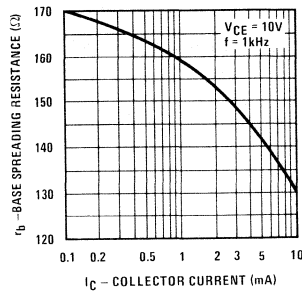

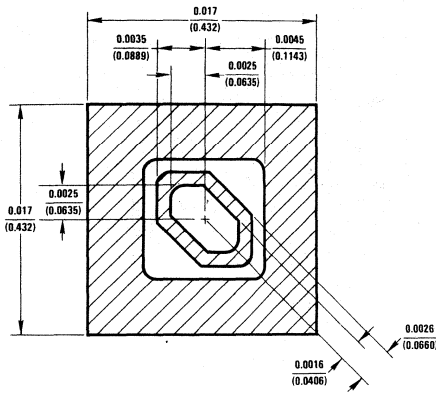

## DESCRIPTION

Process 04 is a non-overlay double diffused silicon epitaxial device. Complement to Process 71.

## APPLICATION

This device was designed for low noise, high gain, general purpose amplifier application. From 1  $\mu$ A to 100 mA collector current.

## PRINCIPAL DEVICE TYPES

TO-18	BC107 Series
TO-92 (ECB)	2N2923 Series
TO-92 (EBC)	MPS2923 Series

PARAMETER	TEST CONDITIONS	MIN	TYP	MAX	UNITS	NOTES
NF (spot)	$I_C = 200 \mu A$ , $V_{CE} = 5V$ $f = 1 \text{ kHz}$ , $R_S = 2k$		2.0	4.0	dB	TO-18
$C_{ob}$	$V_{CB} = 10V$ , $f = 1 \text{ MHz}$		3.2	3.5	pF	TO-18
$C_{ib}$	$V_{EB} = 0.5V$ , $f = 1 \text{ MHz}$		7.6	8.5	pF	TO-18
$f_T$	$V_{CE} = 5V$ , $I_C = 10 \text{ mA}$	150	350		MHz	
$h_{FE}$	$V_{CE} = 5V$ , $I_C = 100 \mu A$	50	250	500		
$h_{FE}$	$V_{CE} = 5V$ , $I_C = 2 \text{ mA}$	50	250	750		
$h_{FE}$	$V_{CE} = 5V$ , $I_C = 100 \text{ mA}$	75	250	300		
$h_{FE}$	$V_{CE} = 1V$ , $I_C = 100 \text{ mA}$	30	100	150		
$V_{CE(sat)}$	$I_C = 10 \text{ mA}$ , $I_B = 1 \text{ mA}$		0.040	0.080	V	
$V_{CE(sat)}$	$I_C = 100 \text{ mA}$ , $I_B = 10 \text{ mA}$		0.120	0.180	V	
$V_{BE(sat)}$	$I_C = 10 \text{ mA}$ , $I_B = 1 \text{ mA}$		0.75	0.85	V	
$V_{BE(sat)}$	$I_C = 100 \text{ mA}$ , $I_B = 10 \text{ mA}$		0.89	0.95	V	
$BV_{CBO}$	$I_C = 10 \mu A$	50	40	120	V	
$BV_{CEO}$	$I_C = 10 \text{ mA}$	20	45	55	V	
$BV_{EBO}$	$I_E = 10 \mu A$	7.0			V	
$I_{CBO}$	$V_{CB} = 40V$			10	NA	
$I_{EBO}$	$V_{EB} = 4V$			10	NA	

# Process 04

**Pulsed DC Current Gain vs Collector Current**

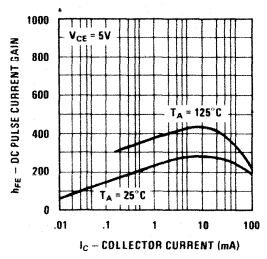

**Base-Emitter On Voltage vs Collector Current**

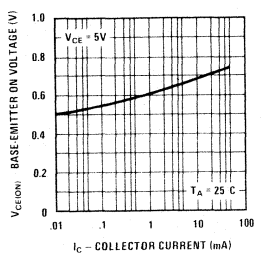

**Base-Emitter Saturation Voltage vs Collector Current**

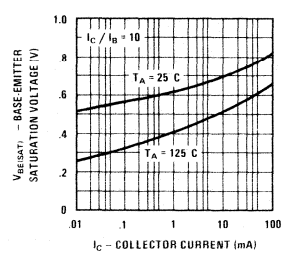

**Collector-Emitter Saturation Voltage vs Collector Current**

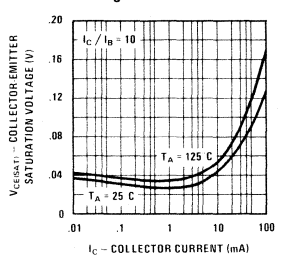

**Contours of Constant Gain Bandwidth Product (FT)**

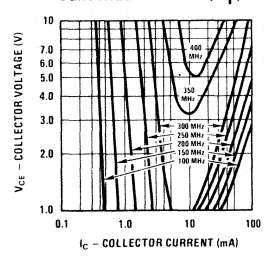

**Input Capacitance vs Reverse Bias Voltage**

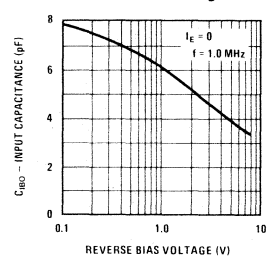

**Output Capacitance vs Reverse Bias Voltage**

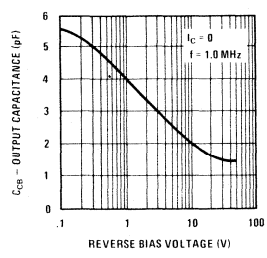

**Maximum Power Dissipation vs Ambient Temperature**

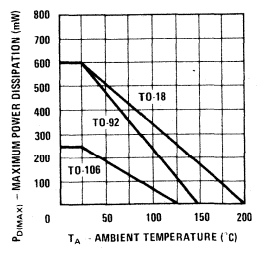

**Maximum Power Dissipation vs Case Temperature**

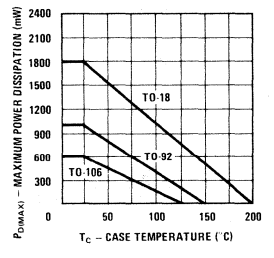

Noise Figure vs Source Resistance

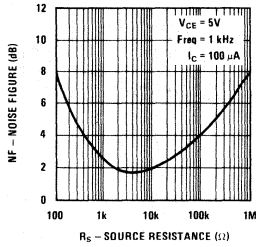

Noise Figure vs Collector Current

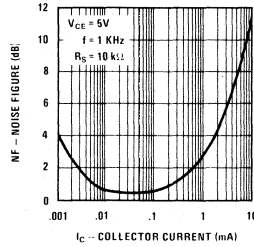

Noise Figure vs Frequency

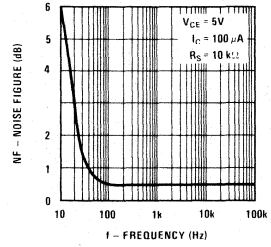

Contours of Constant Narrow Band Noise Figure

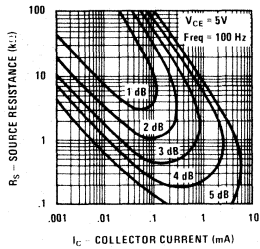

Contours of Constant Narrow Band Noise Figure

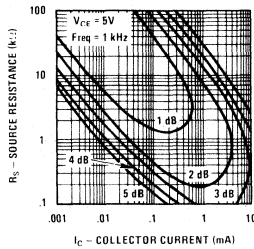

Small Signal Current Gain

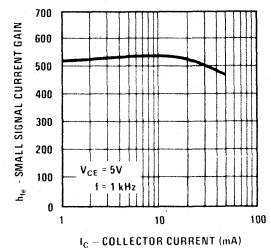

Voltage Feedback Ratio

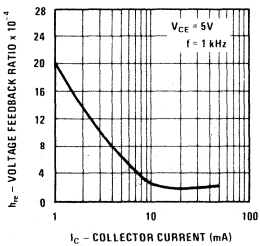

Input Admittance

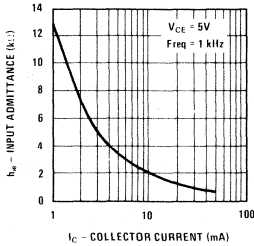

Output Admittance

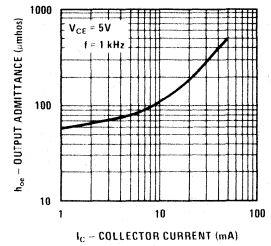

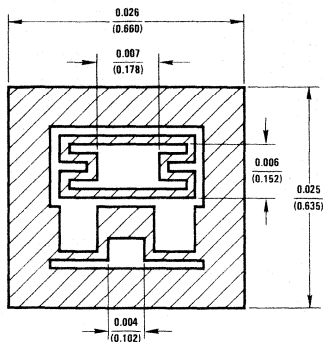
**DESCRIPTION**

Process 05 is a monolithic double diffused, silicon epitaxial Darlington.

**APPLICATION**

This device is designed for applications requiring extremely high current gain at collector currents to 1 Amp.

**PRINCIPAL DEVICE TYPES**

TO-92, MPS-A12 (EBC), 2N5306 (ECB)

PARAMETER	TEST CONDITIONS	MIN	TYP	MAX	UNITS	NOTES
NF	$I_C = 1 \text{ mA}, V_{CE} = 5\text{V}, R_S = 100 \text{ k}, f = 1 \text{ kHz}$		2		dB	
$C_{cb}$	$V_{CB} = 10\text{V}, I_E = 0, f = 1 \text{ MHz}$		4	8	pF	
$h_{FE}$	$I_C = 10 \text{ mA}, V_{CE} = 5\text{V}$ $I_C = 100 \text{ mA}, V_{CE} = 5\text{V}$	5,000 5,000	50,000 100,000	200,000 250,000		
$V_{CE(SAT)}$	10 mA, 0.01 mA 100 mA, 0.1 mA			1.0 1.5	V	
$V_{BE(ON)}$	10 mA, 5V 100 mA, 5V		1.2 1.25	1.4 2.0	V	
$h_{FE}$	$I_C = 10 \text{ mA}, V_{CE} = 5.0\text{V}, f = 1 \text{ kHz}$		80,000			
$BV_{CES}$	$I_C = 100 \mu\text{A}$	30	40	50	V	
$I_{CES}$	$V_{CE} = 15\text{V}, V_{BE} = 0$			100	nA	
$I_{CBO}$	$V_{CB} = 15\text{V}, I_E = 0$			100	nA	
$I_{EBO}$	$V_{EB} = 10\text{V}, I_C = 0$			100	nA	

**DC Pulse Current Gain vs Collector Current**

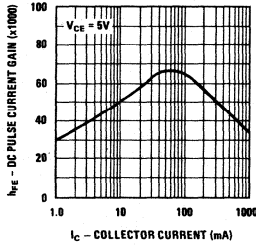

**Base-Emitter On Voltage vs Collector Current**

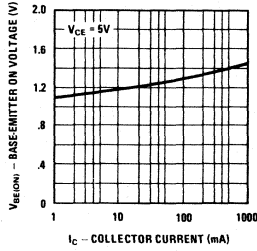

**Maximum Power Dissipation vs Ambient Temperature**

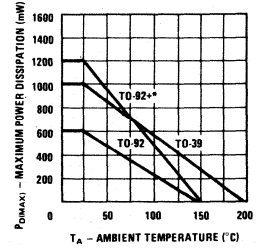

\* One square inch of copper run

**Maximum Power Dissipation vs Case Temperature**

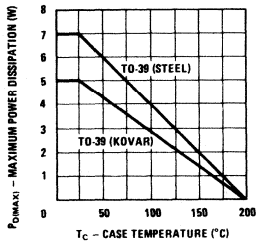

**Maximum Power Dissipation TO-202 vs Case and Ambient Temperature**

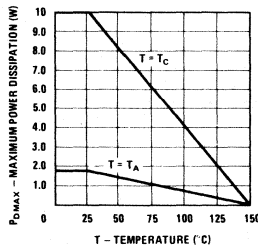

**Collector-Emitter Saturation Voltage vs Collector Current**

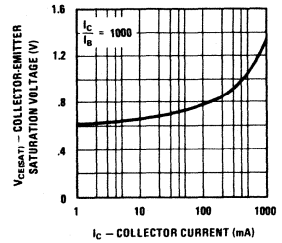

**Base-Emitter Saturation Voltage vs Collector Current**

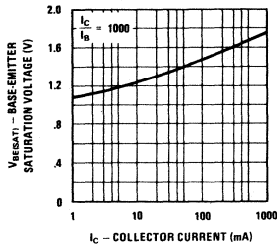

**Input Capacitance vs Reverse Bias Voltage**

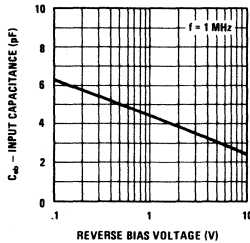

**Output Capacitance vs Reverse Bias Voltage**

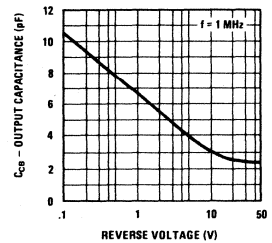

**Small Signal Current Gain vs Collector Current**

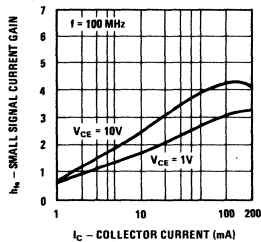

**Collector-Base Diode Reverse Current vs Temperature**

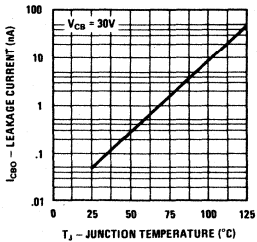

**Collector-Emitter Breakdown Voltage vs Resistance**

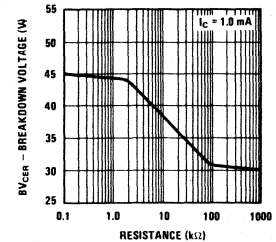

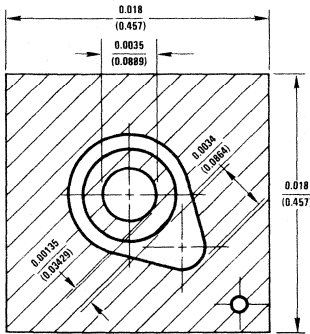
**DESCRIPTION**

Process 07 a nonoverlap, double diffused, silicon epitaxial device. Complement to Process 62.

**APPLICATION**

This device was designed for low noise, high gain general purpose amplifier applications. From 1  $\mu$ A to 25 mA collector current.

**PRINCIPAL DEVICE TYPES**

TO-18      2N930  
TO-92      2N5088 (EBC), 2N3392 (ECB)

PARAMETER	TEST CONDITIONS	MIN	TYP	MAX	UNITS	NOTES
NF (spot)	$I_C = 10 \mu A$ , $V_{CE} = 5V$ , $R_S = 10k$ , $f = 100$ Hz, $P_{BW} = 20$ Hz		3	10	dB	
NF (spot)	$I_C = 10 \mu A$ , $V_{CE} = 5V$ , $R_S = 10k$ , $f = 1$ kHz $P_{BW} = 200$ Hz		1	3	dB	
NF (spot)	$I_C = 10 \mu A$ , $V_{CE} = 5V$ , $R_S = 10k$ , $f = 10$ kHz, $P_{BW} = 2$ kHz		1	3	dB	
NF (wide band)	$I_C = 10 \mu A$ , $V_{CE} = 5V$ , $R_S = 10k$ , $P_{BW} = 15.7$ kHz		1	3	dB	
$h_{fe}$	$I_C = 500 \mu A$ , $V_{CE} = 5V$ , $f = 20$ MHz	5	7			
$C_{cb}$	$V_{CB} = 5V$		1.7	2.5	pF	TO-18
$C_{eb}$	$V_{EB} = 0.50V$		4.5	6.0	pF	TO-18
$h_{FE}$	$I_C = 1 \mu A$ , $V_{CE} = 5V$	35	170	450		
$h_{FE}$	$I_C = 10 \mu A$ , $V_{CE} = 5V$	45	230	670		
$h_{FE}$	$I_C = 100 \mu A$ , $V_{CE} = 5V$	60	300	830		
$h_{FE}$	$I_C = 500 \mu A$ , $V_{CE} = 5V$	65	335	950		
$h_{FE}$	$I_C = 1$ mA, $V_{CE} = 5V$	70	350	1000		
$h_{FE}$	$I_C = 10$ mA, $V_{CE} = 5V$	65	320	900		
$V_{CE(SAT)}$	$I_C = 1$ mA, $I_B = 0.10$ mA		0.06	0.10	V	
$V_{CE(SAT)}$	$I_C = 10$ mA, $I_B = 1$ mA		0.08	0.15	V	
$V_{BE(SAT)}$	$I_C = 1$ mA, $I_B = 0.1$ mA		0.65	0.75	V	
$V_{BE(SAT)}$	$I_C = 10$ mA, $I_B = 1$ mA		0.70	0.85	V	
$BV_{CEO}$	$I_C = 10$ mA	60	80	100	V	
$BV_{CBO}$	$I_C = 100 \mu A$	60			V	
$BV_{EBO}$	$I_C = 10 \mu A$	8			V	
$I_{CBO}$	$V_{CB} = 45V$			10	nA	
$I_{EBO}$	$V_{EB} = 4V$			10	nA	

**Pulsed DC Current Gain vs Collector Current**

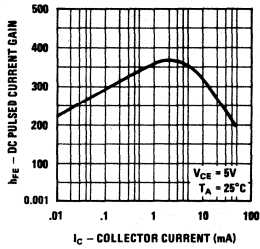

**Small Signal Current Gain vs Collector Current**

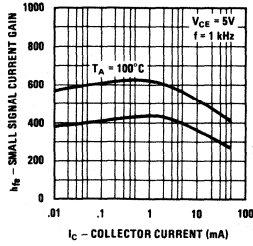

**Base-Emitter On Voltage vs Collector Current**

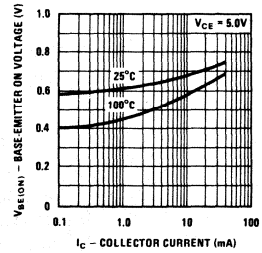

**Collector Saturation Voltage vs Collector Current**

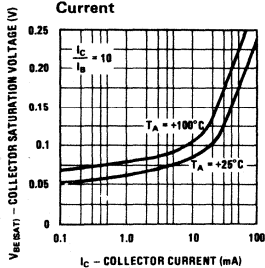

**Base-Emitter Saturation Voltage vs Collector Current**

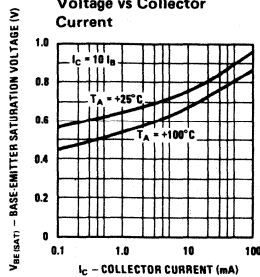

**Contours of Constant Gain Bandwidth Product (fT)**

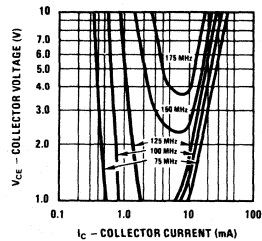

**Input and Output Capacitance vs Reverse Bias Voltage**

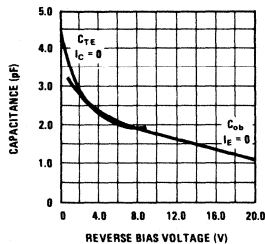

**Normalized Collector Cutoff Current vs Ambient Temperature**

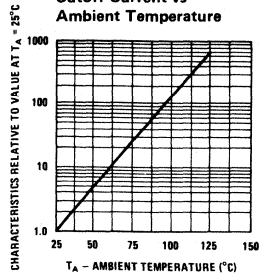

**Maximum Power Dissipation vs Ambient Temperature**

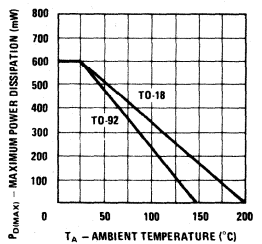

**Maximum Power Dissipation vs Case Temperature**

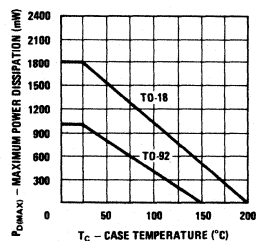

**Wide Band Noise Figure vs Source Resistance**

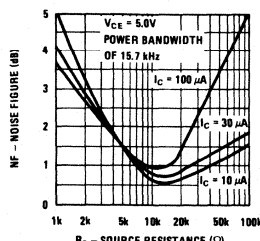

**Contours of Constant Narrow Band Noise Figure**

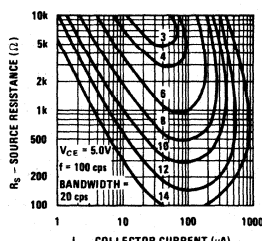



Contours of Constant Narrow Band Noise Figure

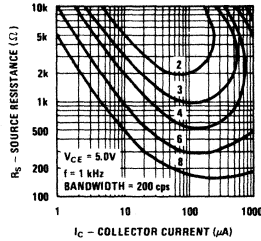

Contours of Constant Narrow Band Noise Figure

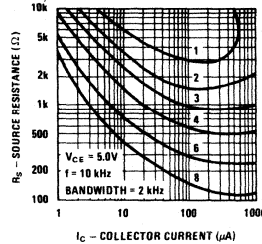

Contours of Constant Narrow Band Noise Figure

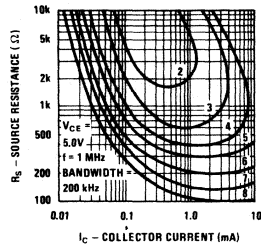

Noise Figure vs Frequency

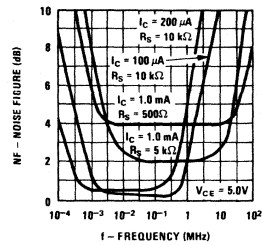

SMALL SIGNAL CHARACTERISTICS (f = 1.0 kHz)

SYMBOL	CHARACTERISTIC	TYP.	UNITS	TEST CONDITIONS
$h_{ie}$	Input Resistance	15	$k\Omega$	$I_C = 1.0 \text{ mA}$ $V_{CE} = 5.0 \text{ V}$
$h_{oe}$	Output Conductance	15	$\mu\text{mho}$	$I_C = 1.0 \text{ mA}$ $V_{CE} = 5.0 \text{ V}$
$h_{re}$	Voltage Feedback Ratio	425	$\times 10^{-6}$	$I_C = 1.0 \text{ mA}$ $V_{CE} = 5.0 \text{ V}$
$h_{fe}$	Small Signal Current Gain	400		$I_C = 1.0 \text{ mA}$ $V_{CE} = 5.0 \text{ V}$
$h_{ib}$	Input Resistance	27	ohms	$I_C = 1.0 \text{ mA}$ $V_{CB} = 5.0 \text{ V}$

TYPICAL COMMON EMITTER CHARACTERISTICS (f = 1.0 kHz)

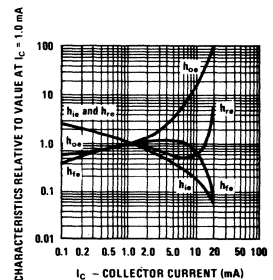
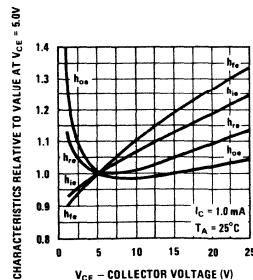
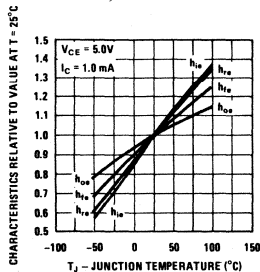



# Process 08 NPN High Voltage

## DESCRIPTION

Complements Process 73.

## APPLICATION

This device was designed as a general purpose amplifier and switch for applications requiring high line voltages.

## PRINCIPAL DEVICE TYPES

TO-39      2N3501

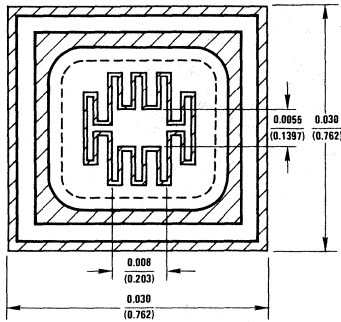

PARAMETER	TEST CONDITIONS	MIN	TYP	MAX	UNITS	NOTES
$BV_{CEO}$	$I_C = 10 \text{ mA}$	100	160	185	V	
$BV_{CBO}$	$I_C = 10 \mu\text{A}$	100			V	
$BV_{EBO}$	$I_E = 10 \mu\text{A}$	6			V	
$I_{CBO}$	$V_{CB} = 50\text{V}$			50	nA	
$I_{EBO}$	$V_{EB} = 4\text{V}$			25	nA	
$h_{FE}$	$I_C = 0.1 \text{ mA}, V_{CE} = 10\text{V}$	20	40			
$h_{FE}$	$I_C = 1 \text{ mA}, V_{CE} = 10\text{V}$	25	70			
$h_{FE}$	$I_C = 10 \text{ mA}, V_{CE} = 10\text{V}$	35	95			
$h_{FE}$	$I_C = 150 \text{ mA}, V_{CE} = 10\text{V}$	40	100	300		
$h_{FE}$	$I_C = 300 \text{ mA}, V_{CE} = 10\text{V}$	15	40			
$V_{CE(SAT)}$	$I_C = 150 \text{ mA}, I_B = 15 \text{ mA}$		0.25	0.4	V	
$V_{BE(SAT)}$	$I_C = 150 \text{ mA}, I_B = 15 \text{ mA}$		0.9	1.2	V	
$C_{OB}$	$V_{CB} = 10\text{V}$		7.5	10	pF	
$C_{iB}$	$V_{EB} = 0.5\text{V}$		65	80	pF	
$f_T$	$I_C = 20 \text{ mA}, V_{CE} = 20\text{V}, f = 100 \text{ MHz}$	150	200		MHz	

# Process 08

**DC Pulsed Current Gain vs Collector Current**

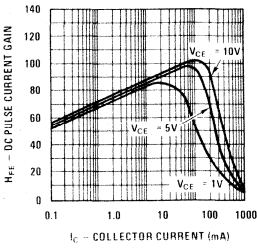

**Base-Emitter On Voltage vs Collector Current**

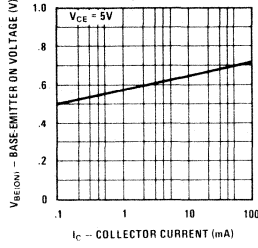

**Maximum Power Dissipation vs Ambient Temperature**

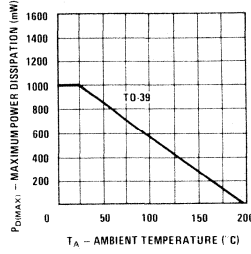

**Maximum Power Dissipation vs Case Temperature**

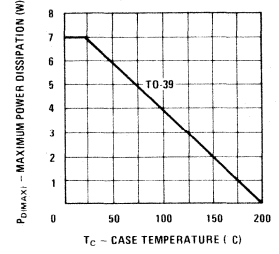

**Base-Emitter Saturation Voltage vs Collector Current**

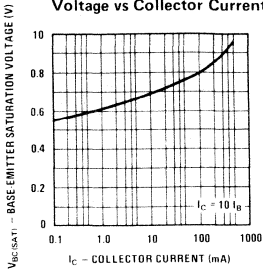

**Collector-Emitter Saturation Voltage vs Collector Current**

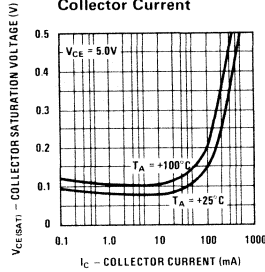

**Collector-Emitter Breakdown Voltage With Resistance Between Emitter and Base**

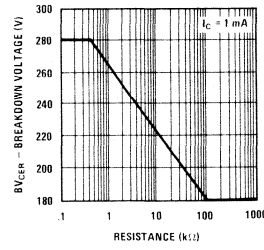

**Small Signal Current Gain vs Collector Current**

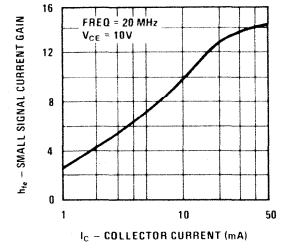

**Input and Output Capacitance vs Reverse Bias Voltage**

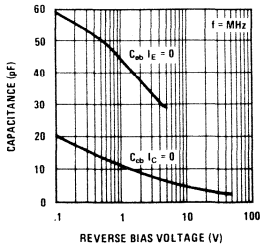

**Collector-Emitter Voltage vs Collector Current**

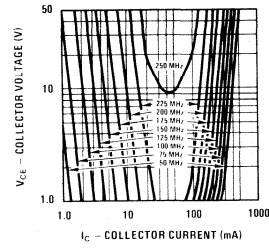

**Safe Operating Area TO-39 With 'Wake Field' Type 296-4 Heat Sink**

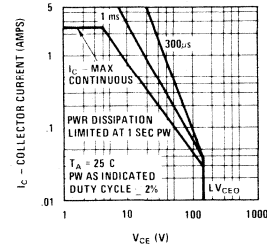

**Collector-Base Diode Current vs Temperature**

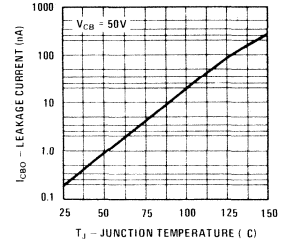

**DESCRIPTION**

Process 09 is a nonoverlay double diffused silicon epitaxial device.

**APPLICATION**

This device was designed for general purpose audio amplifier applications at collector currents to one Amp.

**PRINCIPAL DEVICE TYPES**

TO-92 CS9013

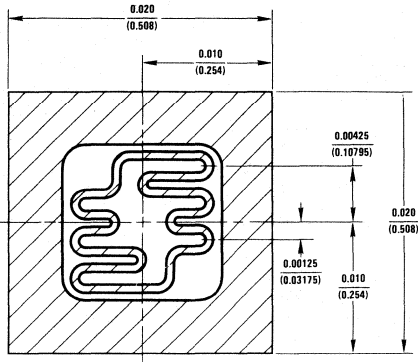

PARAMETER	TEST CONDITIONS	MIN	TYP	MAX	UNITS	NOTES
C <sub>OB</sub>	V <sub>CB</sub> = 10V		5	10	pF	
C <sub>IB</sub>	V <sub>EB</sub> = .5V		25	35	pF	
NF	V <sub>CE</sub> = 10V, I <sub>C</sub> = 1 mA		1.0		dB	
f <sub>T</sub>	R <sub>S</sub> = 1k, f = 1 kHz V <sub>CE</sub> = 10V, I <sub>C</sub> = 100 mA		400		MHz	
h <sub>FE</sub>	V <sub>CE</sub> = 1.0V, I <sub>C</sub> = 1 mA	50	170	290		
h <sub>FE</sub>	V <sub>CE</sub> = 1.0V, I <sub>C</sub> = 50 mA	60	200	350		
h <sub>FE</sub>	V <sub>CE</sub> = 1.0V, I <sub>C</sub> = 500 mA	50	160	280		
h <sub>FE</sub>	V <sub>CE</sub> = 1.0V, I <sub>C</sub> = 1A	35	120	200		
V <sub>CE(SAT)</sub>	I <sub>C</sub> = 150 mA, I <sub>B</sub> = 15 mA		0.09		V	
V <sub>CE(SAT)</sub>	I <sub>C</sub> = 500 mA, I <sub>B</sub> = 50 mA		0.24		V	
V <sub>BE(SAT)</sub>	I <sub>C</sub> = 150 mA, I <sub>B</sub> = 15 mA		0.86		V	
V <sub>BE(SAT)</sub>	I <sub>C</sub> = 500 mA, I <sub>B</sub> = 50 mA		1.0		V	
BV <sub>CB0</sub>	I <sub>C</sub> = 100 μA		100			
BV <sub>CEO</sub>	I <sub>C</sub> = 10 mA	20	25	30		
BV <sub>EBO</sub>	I <sub>E</sub> = 1 μA		7.5			
I <sub>CB0</sub>	V <sub>CB</sub> = 40V			50	nA	
I <sub>EBO</sub>	V <sub>EB</sub> = 4.0V			50	nA	

# Process 09

**DC Pulse Current Gain vs Collector Current**

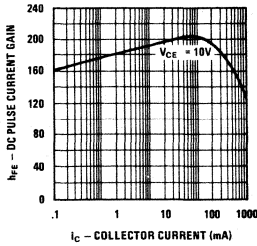

**Base-Emitter On Voltage vs Collector Current**

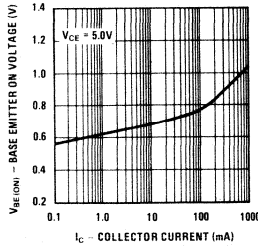

**Maximum Power Dissipation vs Ambient Temperature**

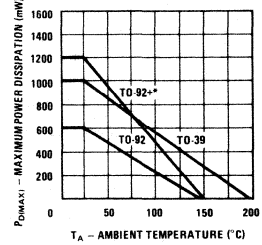

\*One square inch of copper run

**Maximum Power Dissipation vs Case Temperature**

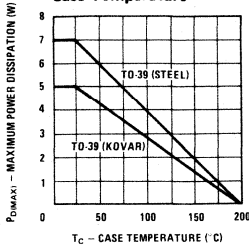

**Collector-Base Diode Reverse Current vs Temperature**

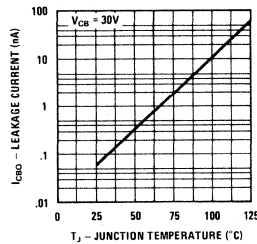

**Collector-Emitter Saturation Voltage vs Collector Current**

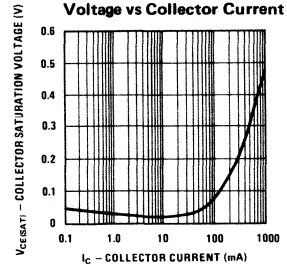

**Base-Emitter Saturation Voltage vs Collector Current**

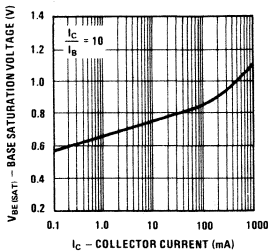

**Capacitance vs Reverse Bias Voltage**

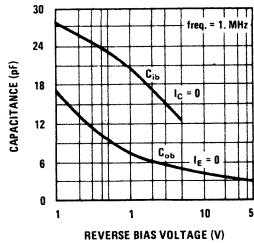

**Contours of Constant Gain Bandwidth Product (fT)**

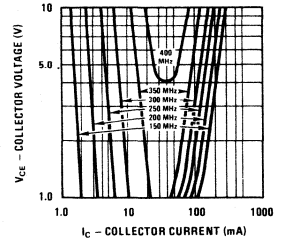

**Noise Figure vs Frequency**

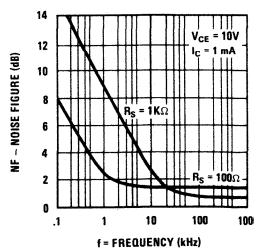

**DESCRIPTION**

Process 12 is a nonoverlay, double diffused silicon epitaxial device. Complement to Process 67.

**APPLICATION**

This device was designed for general purpose medium power amplifiers and switches requiring collector currents up to 1 amp and collector voltages between 80 and 140 volts.

**PRINCIPAL DEVICE TYPES**

TO-92	MPSA05
TO-39	2N3019
TO-202	NSD106
TO-92+	TN3019, TN3020

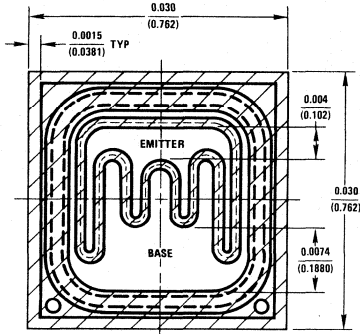

PARAMETER	TEST CONDITIONS	MIN	TYP	MAX	UNITS	NOTES
$t_{on}$	$I_C = 150 \text{ mA}, I_{B1} = 15 \text{ mA}$		50	60	ns	Fig. 1
$t_{off}$	$I_C = 150 \text{ mA}, I_{B2} = 15 \text{ mA}$		400	500	ns	
$h_{fe}$	$I_C = 50 \text{ mA}, V_{CE} = 10 \text{ V}, f = 20 \text{ MHz}$	4.0	6.5			
$C_{cb}$	$V_{CB} = 10 \text{ V}$		6.5	10	pF	TO-39
$C_{eb}$	$V_{EB} = 0.5$		50	60	pF	
NF	$I_C = 100 \mu\text{A}, V_{CE} = 10 \text{ V}, R_S = 1 \text{ k}\Omega$ $f = 1 \text{ kHz}, \text{PBW} = 200 \text{ Hz}$		1.5	4	dB	
$h_{FE}$	$I_C = 100 \mu\text{A}, V_{CE} = 10 \text{ V}$	20	100			
$h_{FE}$	$I_C = 1 \text{ mA}, V_{CE} = 10 \text{ V}$	30	130			
$h_{FE}$	$I_C = 10 \text{ mA}, V_{CE} = 10 \text{ V}$	40	150			
$h_{FE}$	$I_C = 150 \text{ mA}, V_{CE} = 10 \text{ V}$	40	170	300		
$h_{FE}$	$I_C = 500 \text{ mA}, V_{CE} = 10 \text{ V}$	30	130			
$h_{FE}$	$I_C = 1 \text{ A}, V_{CE} = 10 \text{ V}$	20	40			
$V_{CE(SAT)}$	$I_C = 100 \text{ mA}, I_B = 10 \text{ mA}$		0.1	0.2	V	
$V_{CE(SAT)}$	$I_C = 500 \text{ mA}, I_B = 50 \text{ mA}$		0.25	0.5	V	
$V_{BE(SAT)}$	$I_C = 100 \text{ mA}, I_B = 10 \text{ mA}$		0.82	0.90	V	
$V_{BE(SAT)}$	$I_C = 500 \text{ mA}, I_B = 50 \text{ mA}$		1.0	1.20	V	
$BV_{CEO}$	$I_C = 10 \text{ mA}$	65	80	100	V	
$BV_{CBO}$	$I_C = 100 \mu\text{A}$	120			V	
$BV_{CES}$	$I_C = 10 \mu\text{A}$	120			V	
$BV_{EBO}$	$I_C = 10 \mu\text{A}$	7			V	
$I_{CBO}$	$V_{CB} = 90 \text{ V}$			50	nA	
$I_{EBO}$	$V_{EB} = 5 \text{ V}$			50	nA	

# Process 12

**Pulsed DC Current Gain vs Collector Current**

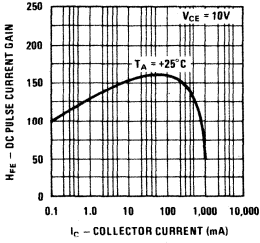

**Base-Emitter On Voltage vs Collector Current**

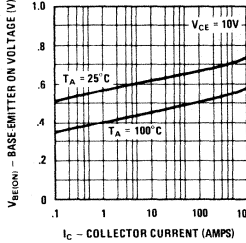

**Maximum Power Dissipation vs Ambient Temperature**

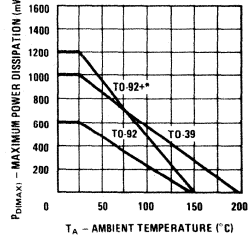

**Maximum Power Dissipation vs Case Temperature**

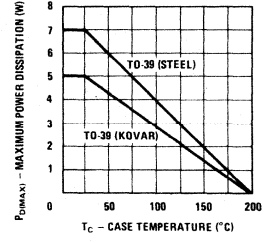

\*One square inch of copper run

**Collector Reverse Current vs Ambient Temperature**

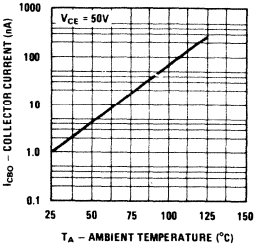

**Emitter Cutoff Current vs Ambient Temperature**

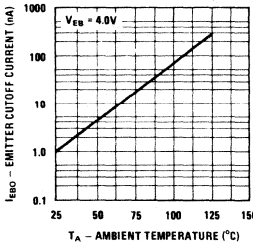

**Small Signal Current Gain at 20 MHz**

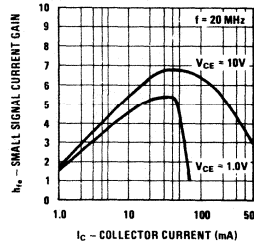

**Collector-Base and Emitter Base Capacitance vs Reverse Bias Voltage**

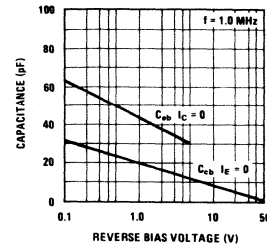

**Noise Figure vs Collector Current**

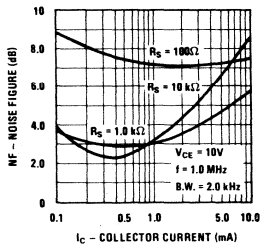

**Noise Figure vs Frequency**

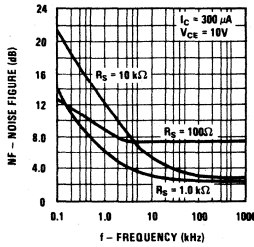

**Collector Saturation Voltage vs Collector Current**

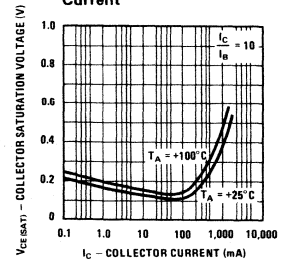

**Base Saturation Voltage vs Collector Current**

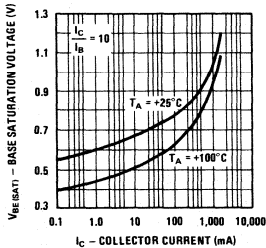

**Safe Operating Area TO-39 With 'Wake Field' Type 296-4 Heat Sink**

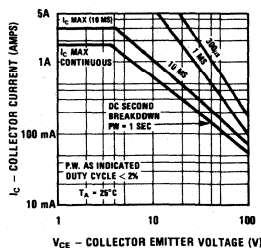

**Switching Times vs Collector Current**

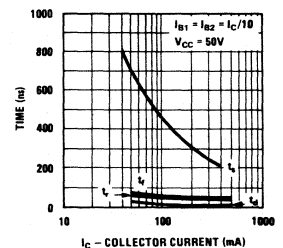

Turn On and Turn Off Times vs Collector Current

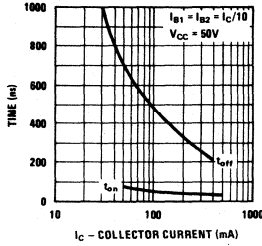

Safe Operating Area TO-202

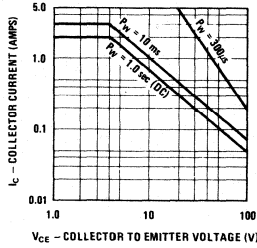

Maximum Power Dissipation TO-202 vs Case and Ambient Temperature

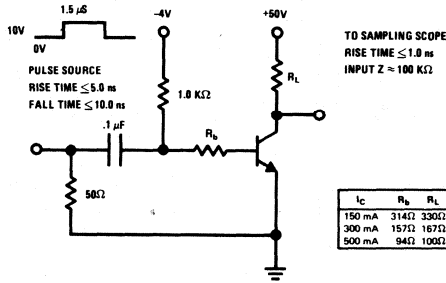
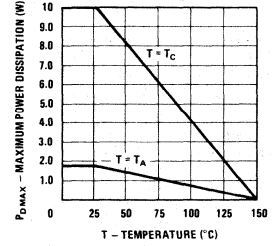
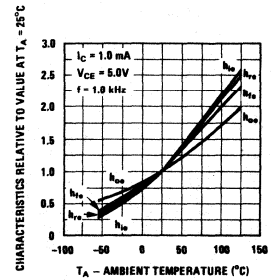
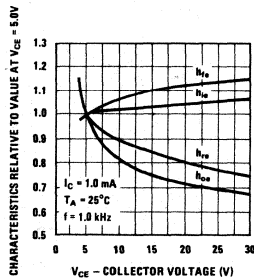
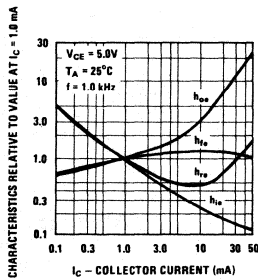

FIGURE 1.  $t_{on}$ ,  $t_{off}$  Test Circuit

SMALL SIGNAL CHARACTERISTICS (f = 1.0 kHz)

SYMBOL	CHARACTERISTIC	TYP.	UNITS	TEST CONDITIONS
$h_{ie}$	Input Resistance	3000	ohms	$I_C = 1.0 \text{ mA}$ $V_{CE} = 5.0V$
$h_{oe}$	Output Conductance	8.0	$\mu\text{mhos}$	$I_C = 1.0 \text{ mA}$ $V_{CE} = 5.0V$
$h_{re}$	Voltage Feedback Ratio	2.1	$\times 10^{-4}$	$I_C = 1.0 \text{ mA}$ $V_{CE} = 5.0V$
$h_{fe}$	Small Signal Current Gain	100		$I_C = 1.0 \text{ mA}$ $V_{CE} = 5.0V$

TYPICAL COMMON EMITTER CHARACTERISTICS (f = 1.0 kHz)



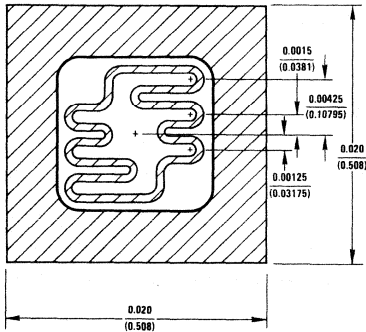

**DESCRIPTION**

Process 13 is a nonoverlay. Complement to Process 63.

**APPLICATION**

These devices were designed for use as medium power amplifiers and switches requiring collector currents of .1 mA to one Amp.

**PRINCIPAL DEVICE TYPES**

TO-92      2N4401 (EBC), 2N3704 (ECB)

PARAMETER	TEST CONDITIONS	MIN	TYP	MAX	UNITS	NOTES
$t_{on}$	$I_C = 150 \text{ mA}$ , $I_{B1} = 15 \text{ mA}$		25	35	ns	
$t_{off}$	$I_C = 150 \text{ mA}$ , $I_{B2} = 15 \text{ mA}$		200	285	ns	
$h_{fe}$	$I_C = 20 \text{ mA}$ , $V_{CE} = 10 \text{ V}$ , $f = 100 \text{ MHz}$	1.8	2.5			
NF (spot)	$I_C = 100 \mu\text{A}$ , $V_{CE} = 10 \text{ V}$ $R_S = 1 \text{ k}\Omega$ , $f = 1 \text{ kHz}$ , PBW = 200 Hz		1.2	4.0	dB	
$C_{ob}$	$V_{CB} = 10 \text{ V}$		4.5		pF	
$C_{ib}$	$V_{EB} = .5 \text{ V}$		22		pF	
$h_{FE}$	$V_{CE} = 1.0 \text{ V}$ , $I_C = 100 \mu\text{A}$	15	80	150		
$h_{FE}$	$V_{CE} = 1.0 \text{ V}$ , $I_C = 1.0 \text{ mA}$	25	110	250		
$h_{FE}$	$V_{CE} = 1.0 \text{ V}$ , $I_C = 10 \text{ mA}$	35	135	300		
$h_{FE}$	$V_{CE} = 1.0 \text{ V}$ , $I_C = 150 \text{ mA}$	40	140	300		
$h_{FE}$	$V_{CE} = 1.0 \text{ V}$ , $I_C = 500 \text{ mA}$	25	100	200		
$h_{FE}$	$V_{CE} = 5.0 \text{ V}$ , $I_C = 1 \text{ A}$	15	45	75		
$V_{CE(SAT)}$	$I_C = 150 \text{ mA}$ , $I_B = 15 \text{ mA}$		0.1	0.2	V	
$V_{CE(SAT)}$	$I_C = 500 \text{ mA}$ , $I_B = 50 \text{ mA}$		0.26	0.36	V	
$V_{BE(SAT)}$	$I_C = 150 \text{ mA}$ , $I_B = 15 \text{ mA}$		0.87	0.97	V	
$V_{BE(SAT)}$	$I_C = 500 \text{ mA}$ , $I_B = 50 \text{ mA}$		1.0	1.2	V	
$BV_{CBO}$	$I_C = 1.0 \mu\text{A}$	60	100	140	V	
$BV_{CES}$	$I_C = 10 \mu\text{A}$	60			V	
$BV_{CEO}$	$I_C = 10 \text{ mA}$	30	40	55	V	
$BV_{EBO}$	$I_E = 1.0 \mu\text{A}$	6.0			V	
$I_{CBO}$	$V_{CB} = 40 \text{ V}$			50	nA	
$I_{EBO}$	$V_{EB} = 4 \text{ V}$			50	nA	

DC Pulse Current Gain vs Collector Current

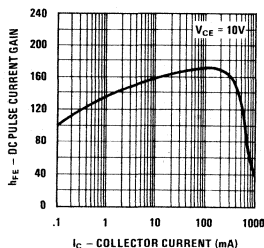

Base-Emitter On Voltage vs Collector Current

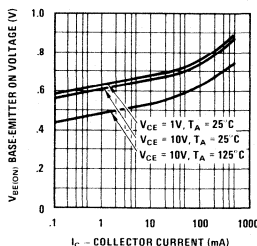

Maximum Power Dissipation vs Ambient Temperature

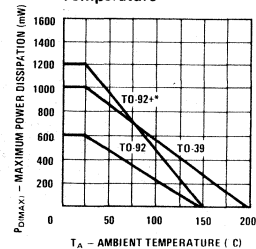

\*One square inch of copper run

Maximum Power Dissipation vs Case Temperature

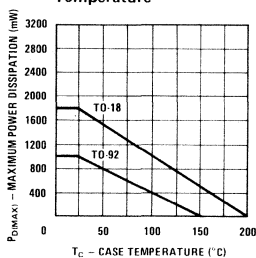

Input Capacitance vs Reverse Bias Voltage

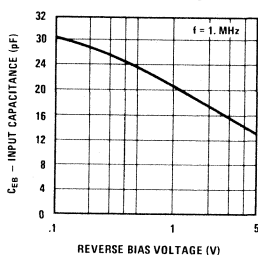

Output Capacitance vs Reverse Bias Voltage

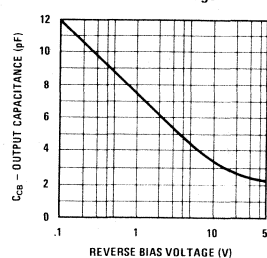

Collector to Base Diode Reverse Current vs Temperature

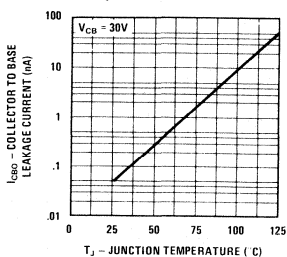

Collector-Emitter Saturation Voltage vs Collector Current

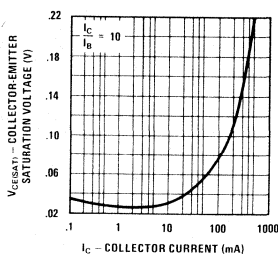

Base-Emitter Saturation Voltage vs Collector Current

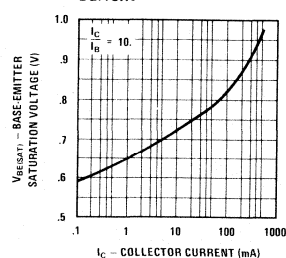

Contours of Constant Gain Bandwidth Product ( $f_T$ )

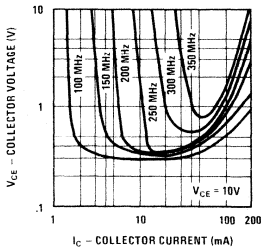

Noise Figure vs Frequency

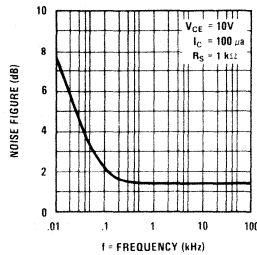

Noise Figure vs Source Resistance

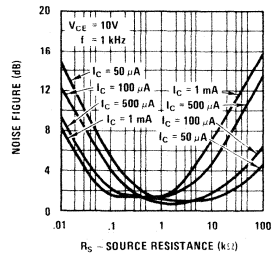

SMALL SIGNAL CHARACTERISTICS ( $f = 1.0 kHz$ )

SYMBOL	CHARACTERISTIC	TYP	UNITS	TEST CONDITIONS
$h_{ie}$	Input Resistance	600	ohms	$I_C = 10 mA, V_{CE} = 10V$
$h_{oe}$	Output Conductance	50	$\mu mhos$	$I_C = 10 mA, V_{CE} = 10V$
$h_{fe}$	Small Signal Current Gain	170		$I_C = 10 mA, V_{CE} = 10V$
$h_{re}$	Voltage Feedback Ratio	120	$\times 10^{-6}$	$I_C = 10 mA, V_{CE} = 10V$

TYPICAL COMMON EMITTER CHARACTERISTICS ( $f = 1.0 kHz$ )

Small Signal Input Resistance vs Collector Current

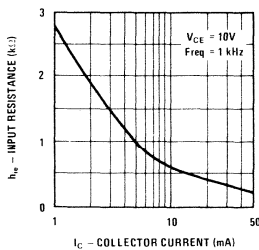

Small Signal Output Conductance vs Collector Current

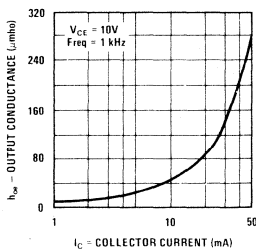

Small Signal Current Gain vs Collector Current

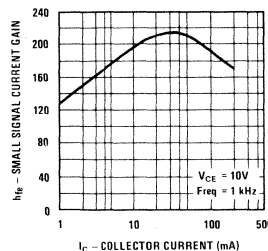

Small Signal Voltage Feedback Ratio vs Collector Current

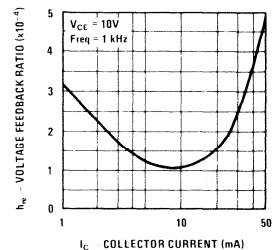

**DESCRIPTION**

Process 14 is a nonoverlay double diffused silicon epitaxial device. Complement to Process 67.

**APPLICATION**

This device was designed for general purpose audio amplifier applications at collector currents to 500 mA.

**PRINCIPAL DEVICE TYPES**

TO-39      BFY50  
TO-92      MPS6560

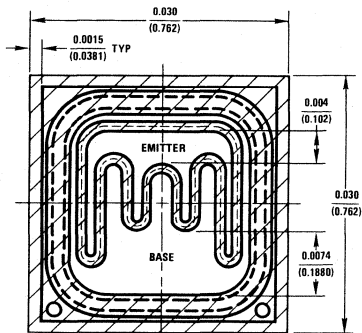

PARAMETER	TEST CONDITIONS	MIN	TYP	MAX	UNITS	NOTES
$C_{ob}$	$V_{CB} = 10V$		8	10	pF	
$C_{ib}$	$V_{EB} = 0.5V$		55	65	pF	
$h_{fe}$	$I_C = 50 \text{ mA}, V_{CE} = 10V, f = 20 \text{ MHz}$	5	10			
$h_{FE}$	$I_C = 0.1 \text{ mA}, V_{CE} = 1V$	20	60			
$h_{FE}$	$I_C = 1 \text{ mA}, V_{CE} = 1V$	20	80			
$h_{FE}$	$I_C = 10 \text{ mA}, V_{CE} = 1V$	20	100	400		
$h_{FE}$	$I_C = 150 \text{ mA}, V_{CE} = 1V$	45	160	300		
$h_{FE}$	$I_C = 500 \text{ mA}, V_{CE} = 1V$	20	70			
$V_{CE(SAT)}$	$I_C = 10 \text{ mA}, I_B = 1 \text{ mA}$		0.04	0.10	V	
$V_{CE(SAT)}$	$I_C = 150 \text{ mA}, I_B = 10 \text{ mA}$		0.10	0.15	V	
$V_{BE(SAT)}$	$I_C = 10 \text{ mA}, I_B = 1 \text{ mA}$		0.70	0.90	V	
$V_{BE(SAT)}$	$I_C = 150 \text{ mA}, I_B = 10 \text{ mA}$		0.80	1.0	V	
$BV_{CEO}$	$I_C = 1 \text{ mA}$	40	50	60	V	
$BV_{CBO}$	$I_C = 100 \mu\text{A}$	80			V	
$BV_{EBO}$	$I_E = 10 \mu\text{A}$	7			V	
$I_{CBO}$	$V_{CB} = 30$			50	nA	
$I_{EBO}$	$V_{EB} = 3$			50	nA	

# Process 14

**DC Pulse Current Gain vs Collector Current**

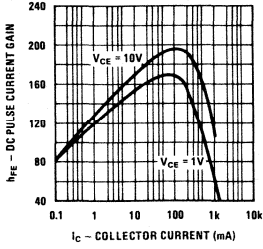

**Base-Emitter On Voltage vs Collector Current**

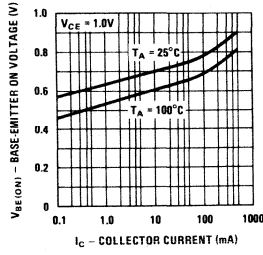

**Maximum Power Dissipation vs Ambient Temperature**

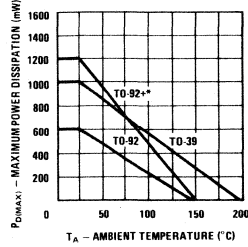

**Maximum Power Dissipation vs Case Temperature**

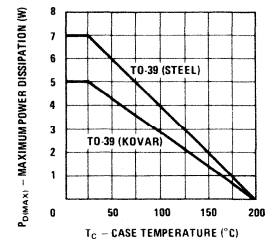

\*One square inch of copper run

**Safe Operating Area TO-39 With "Wake Field" Type 296-4 Heat Sink**

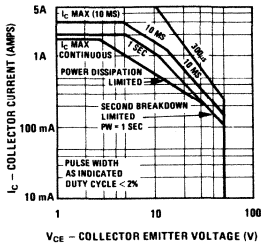

**Collector-Emitter Saturation Voltage vs Collector Current**

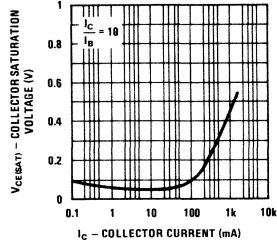

**Base-Emitter Saturation Voltage vs Collector Current**

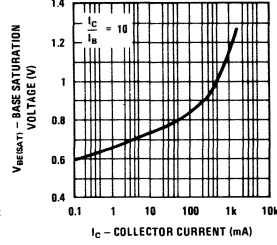

**Capacitance vs Reverse Bias Voltage**

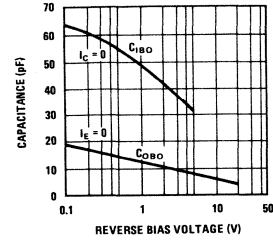

**Collector-Base Diode Reverse Current vs Temperature**

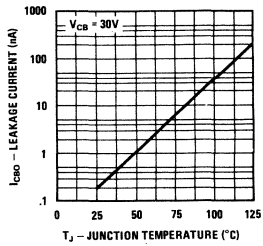

**Small Signal Current Gain At 20 MHz vs Collector Current**

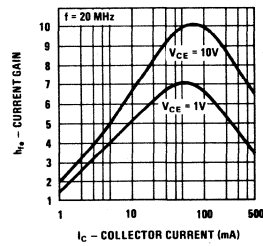

**Input Admittance**

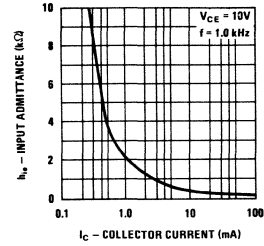

**Small Signal Current Gain**

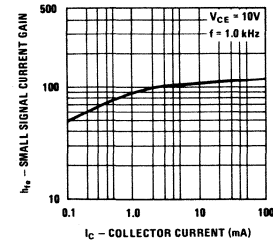

**Voltage Feedback Ratio**

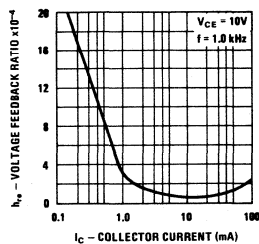

**Output Admittance**

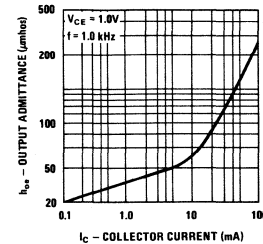

**DESCRIPTION**

Process 16 is a nonoverlay, double diffused, epitaxial silicon device.

**APPLICATION**

This device was designed for general purpose high voltage amplifiers and gas discharge display driving.

**PRINCIPAL DEVICE TYPES**

TO-92      2N5551

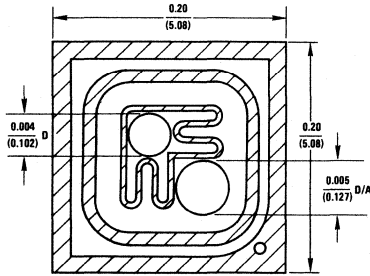

PARAMETER	TEST CONDITIONS	MIN	TYP	MAX	UNITS
$BV_{CEO}$	$I_C = 1.0 \text{ mA}$	100	155	180	V
$BV_{CBO}$	$I_C = 100 \mu\text{A}$	120			V
$BV_{EBO}$	$I_E = 10 \mu\text{A}$	6			V
$I_{CBO}$	$V_{CB} = 120\text{V}$		0.5	50	nA
$I_{EBO}$	$V_{EB} = 4.0\text{V}$		0.3	50	nA
$h_{FE}$	$I_C = 1.0 \text{ mA}, V_{CE} = 5.0\text{V}$	50	105	300	
$h_{FE}$	$I_C = 10 \text{ mA}, V_{CE} = 5.0\text{V}$	50	132	300	
$h_{FE}$	$I_C = 50 \text{ mA}, V_{CE} = 5.0\text{V}$	20	60		
$V_{CE(SAT)}$	$I_C = 10 \text{ mA}, I_B = 1.0 \text{ mA}$		0.07	0.15	V
$V_{CE(SAT)}$	$I_C = 50 \text{ mA}, I_B = 5.0 \text{ mA}$		0.12	0.25	V
$V_{BE(SAT)}$	$I_C = 10 \text{ mA}, I_B = 1.0 \text{ mA}$		0.75	1.0	V
$V_{BE(SAT)}$	$I_C = 50 \text{ mA}, I_B = 5 \text{ mA}$		0.83	1.2	V
$f_T$	$I_C = 10 \text{ mA}, V_{CE} = 10\text{V}, f = 100 \text{ MHz}$	100	220	300	MHz
$C_{ob}$	$V_{CB} = 10\text{V}$		2.67	6.0	pF
$C_{cb}$	$V_{CB} = 10\text{V}$		2.53	4.0	pF
$C_{ib}$	$V_{EB} = 0.5\text{V}$		17	30	pF

# Process 16

**DC Pulse Current Gain vs Collector Current**

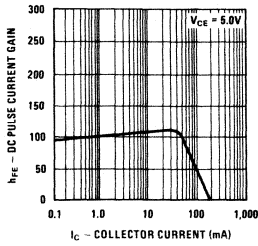

**Base-Emitter on Voltage vs Collector Current**

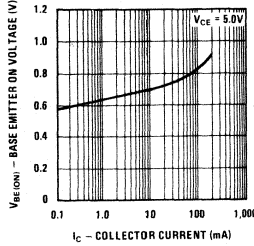

**Maximum Power Dissipation vs Ambient Temperature**

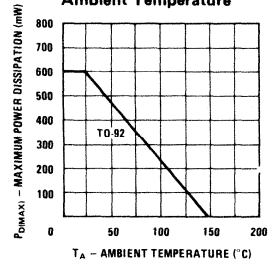

**Maximum Power Dissipation vs Case Temperature**

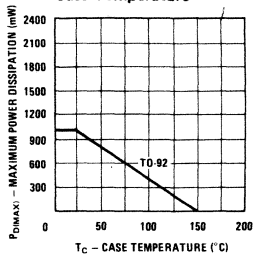

**Base-Emitter Saturation Voltage vs Collector Current**

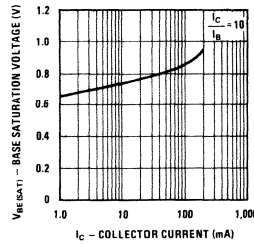

**Collector-Emitter Saturation Voltage vs Collector Current**

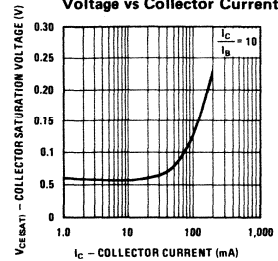

**Collector-Emitter Breakdown Voltage With Resistance Between Emitter-Base**

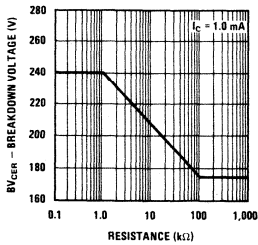

**Small Signal Current Gain vs Collector Current**

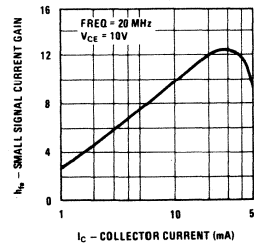

**Input and Output Capacitance vs Reverse Bias Voltage**

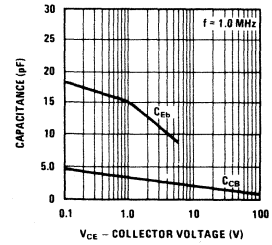

**Contours of Constant Gain Bandwidth Product (fT)**

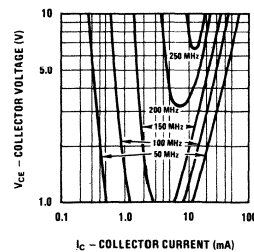

## DESCRIPTION

Process 19 is nonoverlap double diffused, gold doped, silicon epitaxial device. Complement to Process 63.

## APPLICATION

These devices were designed for use as medium power amplifiers and switches requiring collector currents of 0.1 to 500 mA.

## PRINCIPAL DEVICE TYPES

TO-92      PN2222

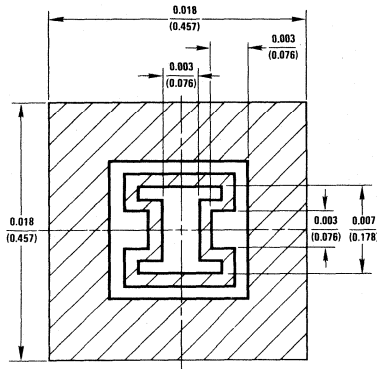

PARAMETER	TEST CONDITIONS	MIN	TYP	MAX	UNITS	NOTES
$t_{on}$	$I_C = 150 \text{ mA}, I_{B1} = 15 \text{ mA}$		25	35	ns	
$t_{off}$	$I_C = 150 \text{ mA}, I_{B2} = 15 \text{ mA}$		200	285	ns	
$h_{fe}$	$I_C = 20 \text{ mA}, V_{CE} = 20 \text{ V}, f = 100 \text{ MHz}$	2.5	3.5			
$C_{cb}$	$V_{CB} = 10 \text{ V}$		3.0	6.0	pF	
$C_{cb}$	$V_{EB} = 0.5 \text{ V}$		18	25	pF	
NF (spot)	$I_C = 100 \mu\text{A}, V_{CE} = 10 \text{ V}$ $R_S = 1 \text{ k}\Omega, f = 1 \text{ kHz}, \text{PBW} = 200 \text{ Hz}$		1.2	4.0	dB	
$h_{FE}$	$I_C = 100 \mu\text{A}, V_{CE} = 10 \text{ V}$	20	100			
$h_{FE}$	$I_C = 1 \text{ mA}, V_{CE} = 10 \text{ V}$	30	160			
$h_{FE}$	$I_C = 10 \text{ mA}, V_{CE} = 10 \text{ V}$	40	200	300		
$h_{FE}$	$I_C = 150 \text{ mA}, V_{CE} = 10 \text{ V}$	45	180	540		
$h_{FE}$	$I_C = 500 \text{ mA}, V_{CE} = 10 \text{ V}$	25	90			
$h_{FE}$	$I_C = 1 \text{ A}, V_{CE} = 10 \text{ V}$	15	30			
$V_{CE(SAT)}$	$I_C = 100 \text{ mA}, I_B = 10 \text{ mA}$		0.12	0.50	V	
$V_{CE(SAT)}$	$I_C = 500 \text{ mA}, I_B = 50 \text{ mA}$		0.35	1.0	V	
$V_{BE(SAT)}$	$I_C = 100 \text{ mA}, I_B = 10 \text{ mA}$		0.90	1.2	V	
$V_{BE(SAT)}$	$I_C = 500 \text{ mA}, I_B = 50 \text{ mA}$		1.1	1.5	V	
$BV_{CEO}$	$I_C = 10 \text{ mA}$	30	50	60	V	
$BV_{CBO}$	$I_C = 100 \mu\text{A}$	45			V	
$BV_{CES}$	$I_C = 10 \mu\text{A}$	45		85	V	
$BV_{EBO}$	$I_E = 10 \mu\text{A}$	6			V	
$I_{CBO}$	$V_{CB} = 60 \text{ V}$			50	nA	
$I_{EBO}$	$V_{EB} = 3 \text{ V}$			50	nA	



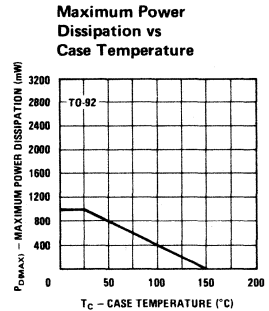
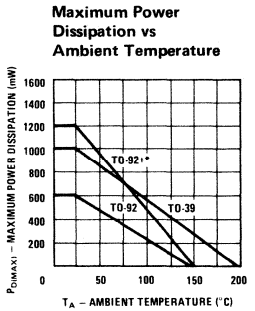
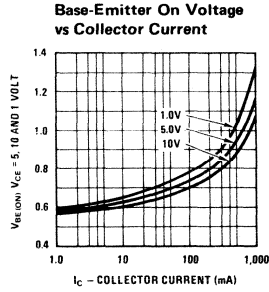
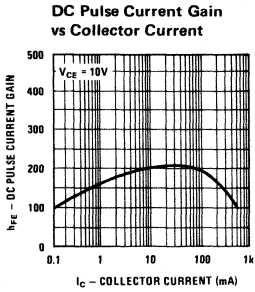

\*One square inch of copper run

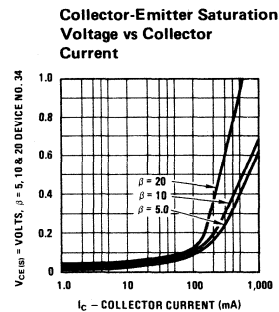
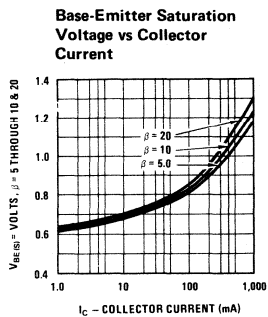
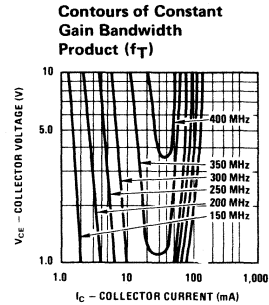
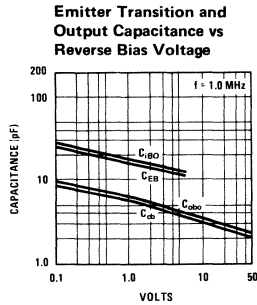

## DESCRIPTION

Process 20 is nonoverlay double diffused, gold doped, silicon epitaxial device. Complement to Process 63.

## APPLICATION

These devices were designed for use as medium power amplifiers and switches requiring collector currents of 0.1 to 500 mA.

## PRINCIPAL DEVICE TYPES

TO-5	2N2219A
TO-18	2N2222A
TO-92	MPS3642
TO-105	2N3643
TO-106	2N4141

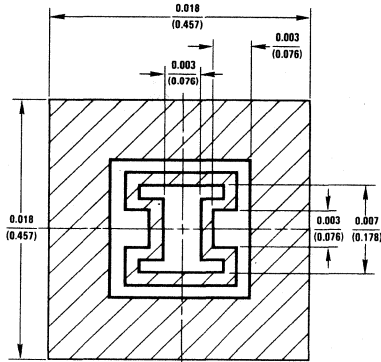

PARAMETER	TEST CONDITIONS	MIN	TYP	MAX	UNITS	NOTES
$t_{on}$	$I_C = 150 \text{ mA}, I_{B1} = 15 \text{ mA}$		25	35	ns	
$t_{off}$	$I_C = 150 \text{ mA}, I_{B2} = 15 \text{ mA}$		200	285	ns	
$h_{fe}$	$I_C = 20 \text{ mA}, V_{CE} = 20 \text{ V}, f = 100 \text{ MHz}$	2.5	3.5			
$C_{cb}$	$V_{CB} = 10 \text{ V}$		3.0	6.0	pF	
$C_{ib}$	$V_{EB} = 0.5 \text{ V}$		19	25	pF	
NF (spot)	$I_C = 100 \mu\text{A}, V_{CE} = 10 \text{ V}$ $R_S = 1 \text{ k}\Omega, f = 1 \text{ kHz}, \text{PBW} = 200 \text{ Hz}$		1.2	4.0	dB	
$h_{FE}$	$I_C = 100 \mu\text{A}, V_{CE} = 10 \text{ V}$	30	100			
$h_{FE}$	$I_C = 1 \text{ mA}, V_{CE} = 10 \text{ V}$	40	195			
$h_{FE}$	$I_C = 10 \text{ mA}, V_{CE} = 10 \text{ V}$	50	240	500		
$h_{FE}$	$I_C = 150 \text{ mA}, V_{CE} = 10 \text{ V}$	50	180	500		
$h_{FE}$	$I_C = 500 \text{ mA}, V_{CE} = 10 \text{ V}$	30	90			
$h_{FE}$	$I_C = 1 \text{ A}, V_{CE} = 10 \text{ V}$	15	30			
$V_{CE(SAT)}$	$I_C = 100 \text{ mA}, I_B = 10 \text{ mA}$		0.12	0.50	V	
$V_{CE(SAT)}$	$I_C = 500 \text{ mA}, I_B = 50 \text{ mA}$		0.35	1.0	V	
$V_{BE(SAT)}$	$I_C = 100 \text{ mA}, I_B = 10 \text{ mA}$		0.90	1.2	V	
$V_{BE(SAT)}$	$I_C = 500 \text{ mA}, I_B = 50 \text{ mA}$		1.00	1.5	V	
$BV_{CEO}$	$I_C = 10 \text{ mA}$	40			V	
$BV_{CBO}$	$I_C = 100 \mu\text{A}$	70			V	
$BV_{EBO}$	$I_E = 10 \mu\text{A}$	6			V	
$I_{CBO}$	$V_{CB} = 60 \text{ V}$			50	nA	
$I_{EBO}$	$V_{EB} = 3 \text{ V}$			50	nA	

DC Pulse Current Gain vs Collector Current

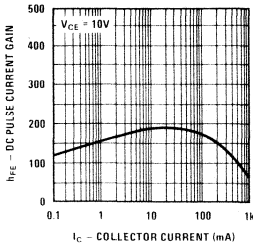

Base-Emitter On Voltage vs Collector Current

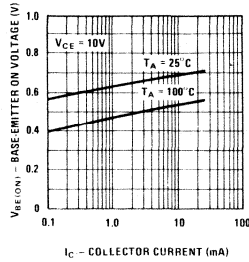

Collector Reverse Current vs Ambient Temperature

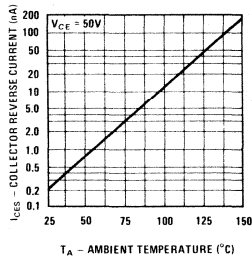

Emitter Cutoff Current vs Ambient Temperature

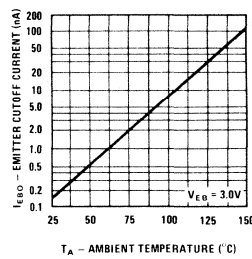

Maximum Power Dissipation vs Ambient Temperature

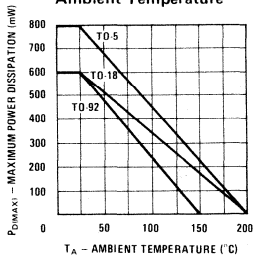

Maximum Power Dissipation vs Case Temperature

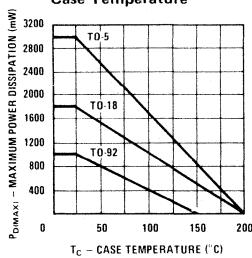

Emitter Transition and Output Capacitance vs Reverse Bias Voltage

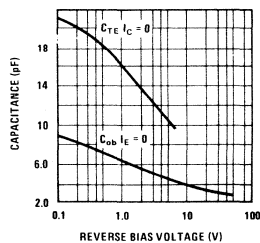

Contours of Constant Gain Bandwidth Product (fT)

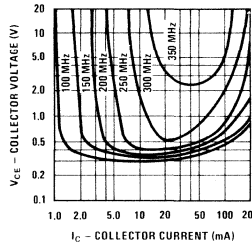

Noise Figure vs Collector Current

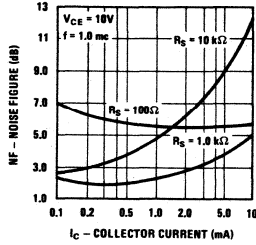

Noise Figure vs Frequency

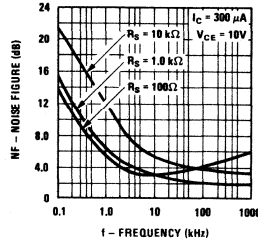

Collector Saturation Voltage vs Collector Current

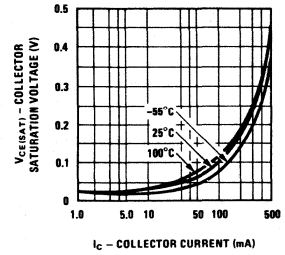

Base Saturation Voltage vs Collector Current

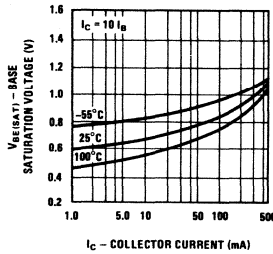

Switching Times vs Collector Current

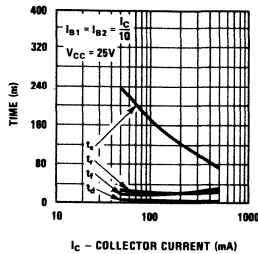

Turn On and Turn Off Times vs Collector Current

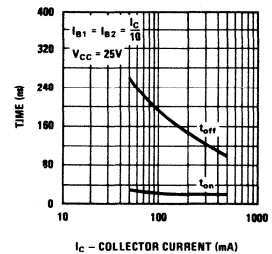

SMALL SIGNAL CHARACTERISTICS (f = 1.0 kHz)

SYMBOL	CHARACTERISTIC	TY P	UNITS	TEST CONDITIONS
$h_{ie}$	Input Resistance	700	ohms	$I_C = 10 \text{ mA}$ $V_{CE} = 10\text{V}$
$h_{oe}$	Output Conductance	120	$\mu\text{mhos}$	$I_C = 10 \text{ mA}$ $V_{CE} = 10\text{V}$
$h_{fe}$	Small Signal Current Gain	240		$I_C = 10 \text{ mA}$ $V_{CE} = 10\text{V}$
$h_{re}$	Voltage Feedback Ratio	460	$\times 10^{-6}$	$I_C = 10 \text{ mA}$ $V_{CE} = 10\text{V}$

TYPICAL COMMON EMITTER CHARACTERISTICS (f = 1.0 kHz)

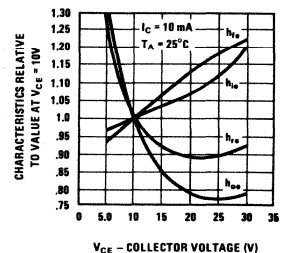
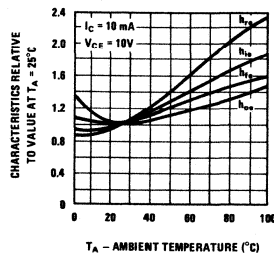
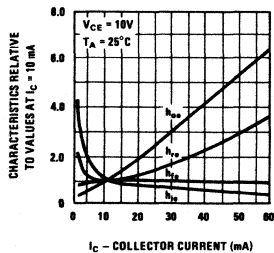

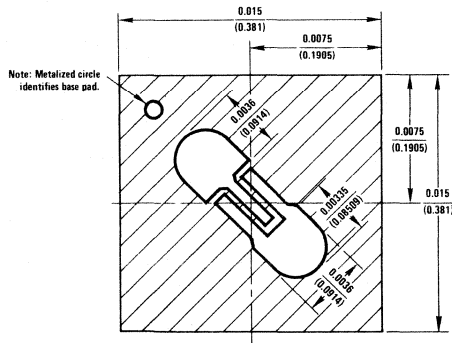
**DESCRIPTION**

Process 21 is an overlay, double diffused, gold doped silicon epitaxial device. Complement to Process 65.

**APPLICATION**

This device was designed for high speed saturated switching at collector currents of 10 to 100 mA.

**PRINCIPAL DEVICE TYPES**

TO-18      2N2369A  
TO-92      MPS2369 (EBC)

PARAMETER	TEST CONDITIONS	MIN	TYP	MAX	UNITS	NOTES
$t_s$	$I_{B1} = I_{B2} = I_C = 10 \text{ mA}$		7	13	ns	Fig. 1
$t_{on}$	$I_C = 10 \text{ mA}, I_{B1} = 3 \text{ mA}$		9	12	ns	Fig. 2
$t_{off}$	$I_C = 10 \text{ mA}, I_{B2} = 1.50 \text{ mA}$		10	18	ns	Fig. 2
$h_{fe}$	$I_C = 10 \text{ mA}, V_{CE} = 10 \text{ V}, f = 100 \text{ MHz}$	5.0	6.5			
$C_{cb}$	$V_{CB} = 5 \text{ V}$		2.0	4.0	pF	TO-18
$C_{eb}$	$V_{EB} = 0.5 \text{ V}$		4.0	5.0	pF	TO-18
$h_{FE}$	$I_C = 1 \text{ mA}, V_{CE} = 1 \text{ V}$	30	65	150		
$h_{FE}$	$I_C = 10 \text{ mA}, V_{CE} = 1 \text{ V}$	30	70	150		
$h_{FE}$	$I_C = 50 \text{ mA}, V_{CE} = 1 \text{ V}$	25	55	150		
$h_{FE}$	$I_C = 100 \text{ mA}, V_{CE} = 1 \text{ V}$	20	30	150		
$h_{FE}$	$I_C = 10 \text{ mA}, V_{CE} = 0.35 \text{ V}$	30	65	150		
$h_{FE}$	$I_C = 30 \text{ mA}, V_{CE} = 0.4 \text{ V}$	30	60	150		
$V_{CE(SAT)}$	$I_C = 10 \text{ mA}, I_B = 1 \text{ mA}$		0.15	0.2	V	
$V_{CE(SAT)}$	$I_C = 100 \text{ mA}, I_B = 10 \text{ mA}$		0.35	0.5	V	
$V_{BE(SAT)}$	$I_C = 10 \text{ mA}, I_B = 1 \text{ mA}$		0.80	0.85	V	
$V_{BE(SAT)}$	$I_C = 100 \text{ mA}, I_B = 10 \text{ mA}$		1.0	1.5	V	
$BV_{CEO}$	$I_C = 10 \text{ mA}$	12	15	19	V	
$BV_{CBO}$	$I_C = 10 \mu\text{A}$	50	55	60	V	
$BV_{EBO}$	$I_E = 10 \mu\text{A}$	4.5			V	
$I_{CBO}$	$V_{CB} = 25 \text{ V}$			50	nA	
$I_{EBO}$	$V_{EB} = 3 \text{ V}$			50	nA	

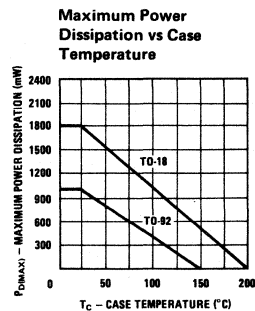
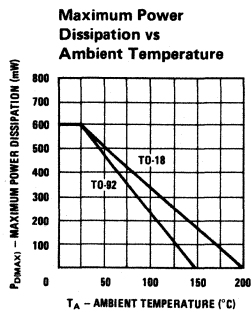
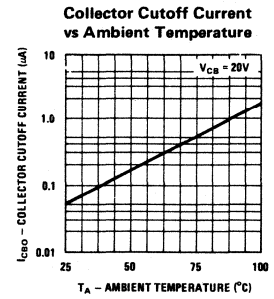
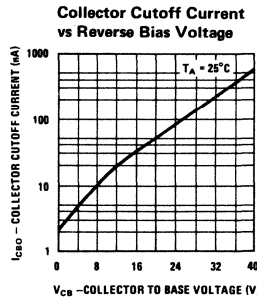
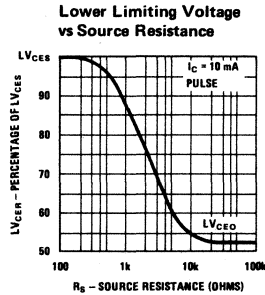
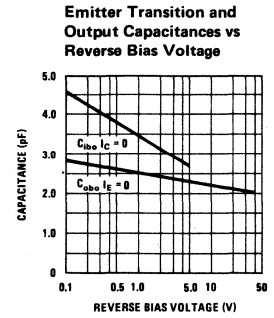
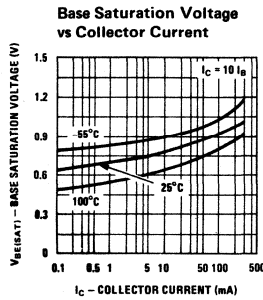
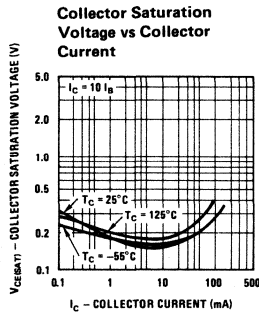
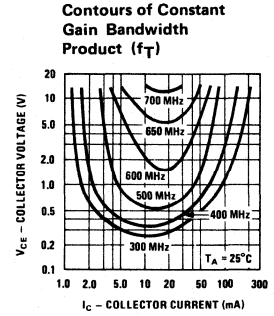
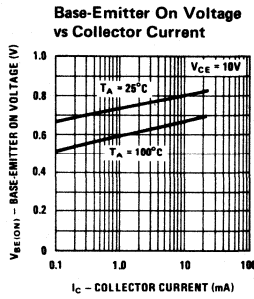
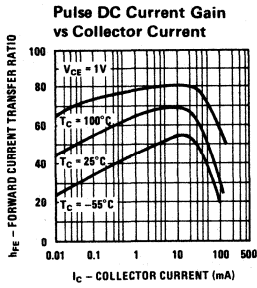

**Switching Times vs Collector Current**

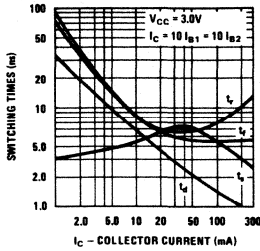

**Switching Times vs Ambient Temperature**

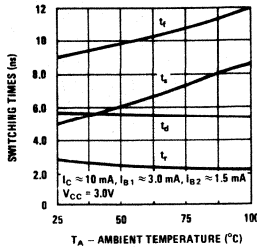

**Average Propagation Delay Per Transistor vs Collector Voltage**

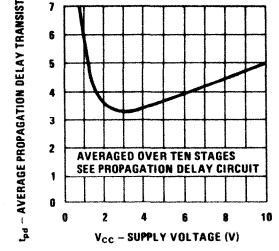

**Storage Time vs Turn On and Turn Off Base Currents**

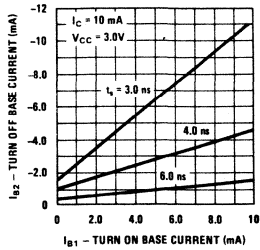

**Storage Time vs Turn On and Turn Off Base Currents**

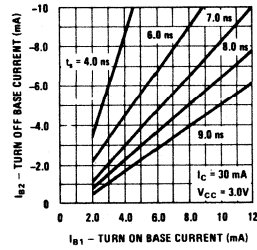

**Storage Time vs Turn On and Turn Off Base Currents**

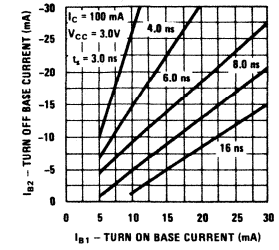

**Fall Time vs Turn On and Turn Off Base Current**

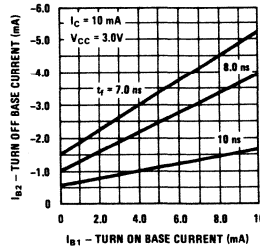

**Fall Time vs Turn On and Turn Off Base Currents**

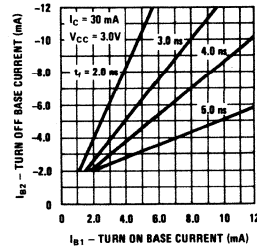

**Fall Time vs Turn On and Turn Off Base Currents**

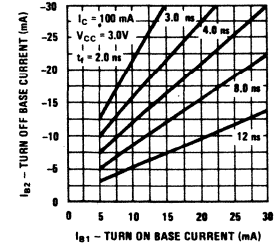

**Delay Time vs Base Emitter Off Voltage and Turn On Base Current**

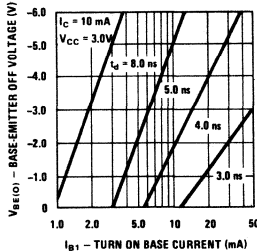

**Rise Time vs Turn On Base Current and Collector Current**

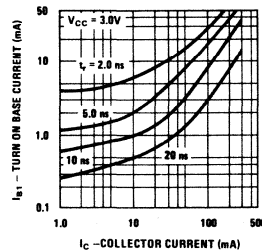

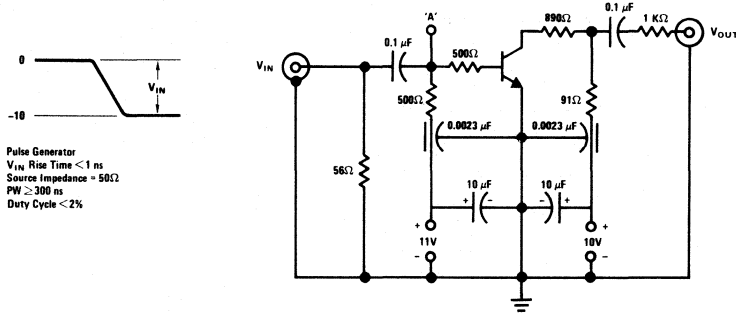

FIGURE 1. Charge Storage Time Measurement Circuit

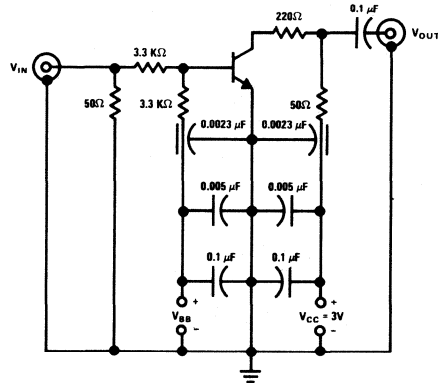
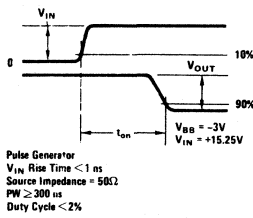

FIGURE 2.  $t_{on}$ ,  $t_{off}$  Measurement Circuit

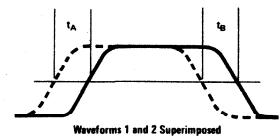
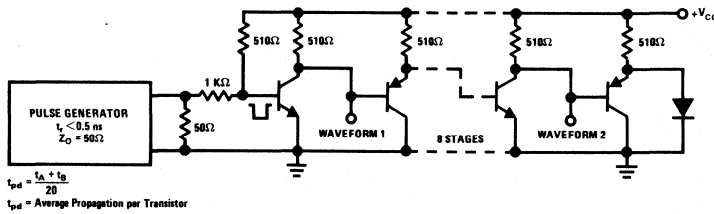
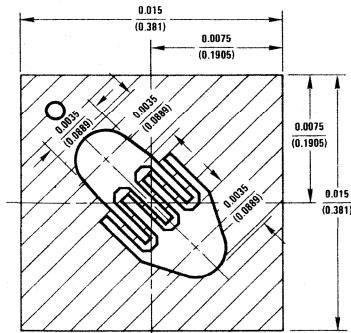

FIGURE 3. Circuit For Measurement of Propagation Delay



**DESCRIPTION**

Process 22 is an overlay, double diffused, gold doped silicon epitaxial device. Complement to Process 64.

**APPLICATION**

This device was designed for high speed logic and core driver applications to 300 mA.

**PRINCIPAL DEVICE TYPES**

TO-52            2N3013  
TO-92            2N5772

PARAMETER	TEST CONDITIONS	MIN	TYP	MAX	UNITS	NOTES
$t_s$	$I_C = 10 \text{ mA}, I_{B1} = I_{B2} = 10 \text{ mA}$		12	18	ns	Fig. 1
$t_{on}$	$I_C = 300 \text{ mA}, I_{B1} = I_{B2} = 30 \text{ mA}$		10	18	ns	Fig. 2
$t_{off}$	$I_C = 300 \text{ mA}, I_{B1} = I_{B2} = 30 \text{ mA}$		18	30	ns	
$C_{ob}$	$V_{CB} = 5V$		3.2	5.0	pF	TO-18
$C_{ob}$	$V_{EB} = 0.5V$		6.2	8.0	pF	TO-18
$h_{fe}$	$I_C = 30 \text{ mA}, V_{CE} = 10V, f = 100 \text{ MHz}$	3.5	7.0	10		
$h_{FE}$	$V_{CE} = 1V, I_C = 10 \text{ mA}$	20	50	150		
$h_{FE}$	$V_{CE} = 1V, I_C = 30 \text{ mA}$	20	50	150		
$h_{FE}$	$V_{CE} = 1V, I_C = 100 \text{ mA}$	20	48	150		
$h_{FE}$	$V_{CE} = 1V, I_C = 300 \text{ mA}$	15	30	120		
$h_{FE}$	$V_{CE} = 0.4V, I_C = 30 \text{ mA}$	20	50	150		
$h_{FE}$	$V_{CE} = 0.5V, I_C = 100 \text{ mA}$	20	50	150		
$V_{CE(SAT)}$	$I_C = 30 \text{ mA}, I_B = 3 \text{ mA}$		0.14	0.20	V	
$V_{CE(SAT)}$	$I_C = 100 \text{ mA}, I_B = 10 \text{ mA}$		0.20	0.28	V	
$V_{CE(SAT)}$	$I_C = 300 \text{ mA}, I_B = 30 \text{ mA}$		0.40	0.50	V	
$V_{BE(SAT)}$	$I_C = 30 \text{ mA}, I_B = 3 \text{ mA}$		0.80	0.95	V	
$V_{BE(SAT)}$	$I_C = 100 \text{ mA}, I_B = 10 \text{ mA}$		0.92	1.2	V	
$V_{BE(SAT)}$	$I_C = 300 \text{ mA}, I_B = 30 \text{ mA}$		1.1	1.7	V	
$BV_{CBO}$	$I_C = 100 \mu A$	40	50		V	
$BV_{CEO}$	$I_C = 10 \text{ mA}$	15	18		V	
$BV_{EBO}$	$I_E = 100 \mu A$	5.0	5.7		V	
$I_{CBO}$	$V_{CB} = 20V$			50	nA	
$I_{EBO}$	$V_{EB} = 3V$			50	nA	

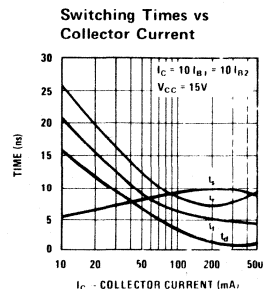
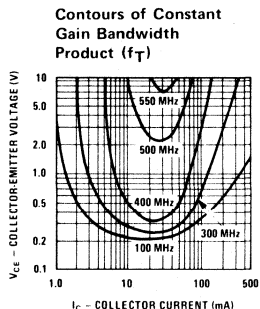
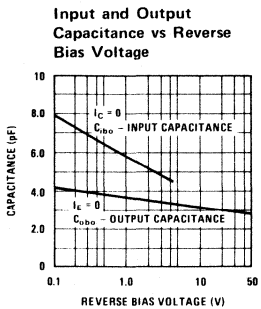
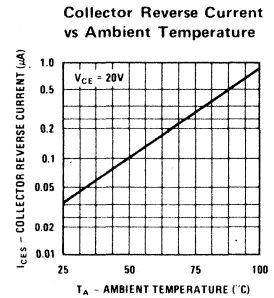
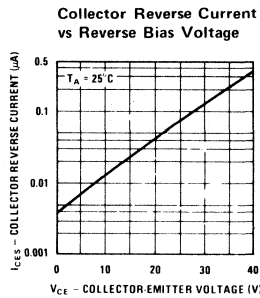
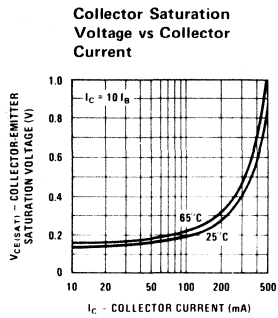
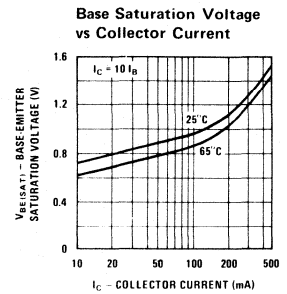
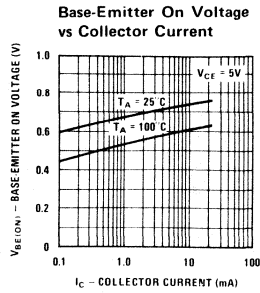
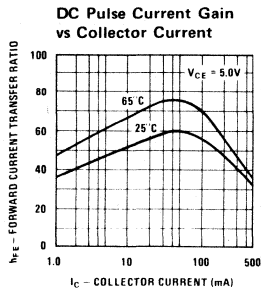

# Process 22

Storage Time vs Turn On and Turn Off Base Currents

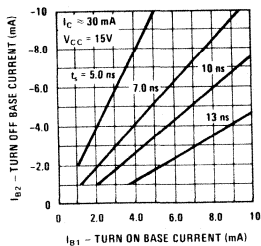

Storage Time vs Turn On and Turn Off Base Currents

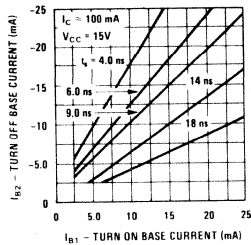

Storage Time vs Base On and Turn Off Base Currents

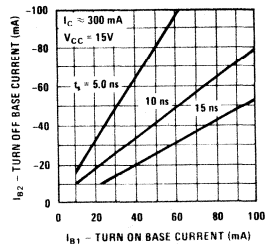

Fall Time vs Turn On and Turn Off Base Currents

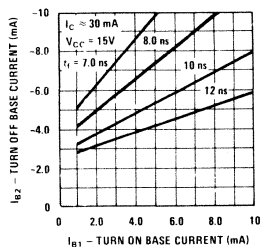

Fall Time vs Turn On and Turn Off Base Currents

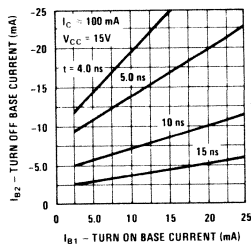

Fall Time vs Turn On and Turn Off Base Currents

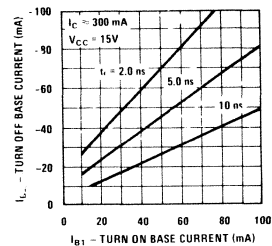

Delay Time vs Base Emitter Off Voltage and Turn On Base Current

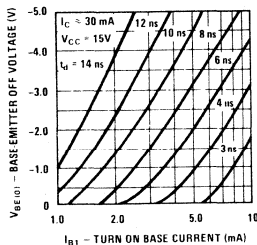

Rise Time vs Collector and Turn On Base Currents

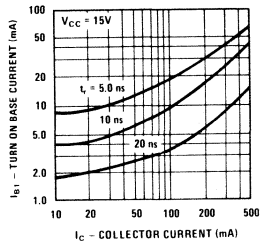

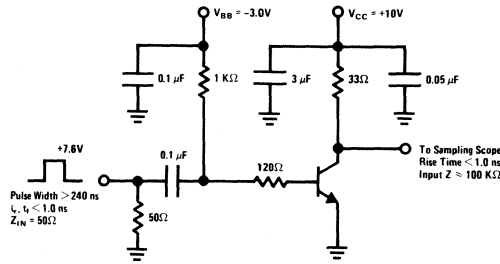
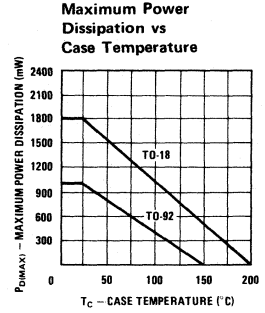
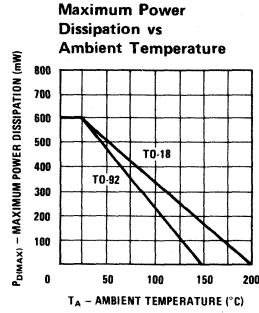
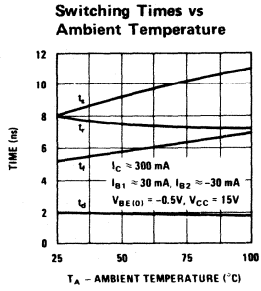

FIGURE 1.  $t_{on}$ ,  $t_{off}$  Test Circuit

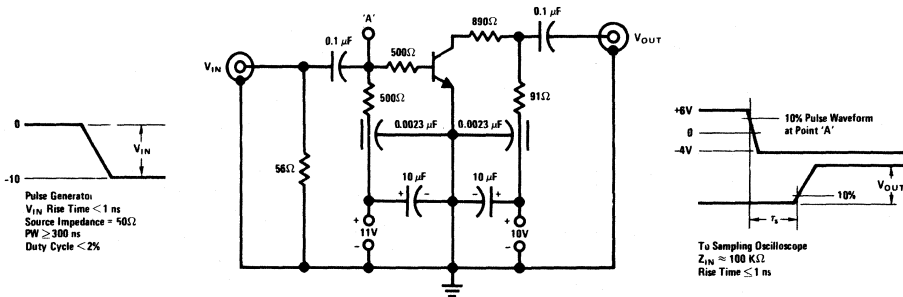
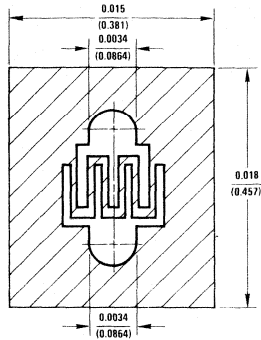

FIGURE 2. Charge Storage Time Measurement Circuit

**DESCRIPTION**

Process 23 is an overlay, double diffused gold doped silicon epitaxial device. Complement to Process 66.

**APPLICATION**

This device is designed as general purpose amplifier and switch. The useful dynamic range extends to 100 mA as a switch and to 100 MHz as an amplifier.

**PRINCIPAL DEVICE TYPES**

TO-18	NS3904
TO-92	2N3904

PARAMETER	TEST CONDITIONS	MIN	TYP	MAX	UNITS	NOTES
$t_{on}$	$I_C = 10 \text{ mA}, I_{B1} = 1 \text{ mA}$		30	70	ns	Fig. 1
$t_{off}$	$I_C = 10 \text{ mA}, I_{B2} = 1 \text{ mA}$		150	250	ns	Fig. 2
$C_{ob}$	$V_{CB} = 5 \text{ V}, f = 1 \text{ MHz}$		2.7	4.0	pF	TO-18
$C_{ib}$	$V_{EB} = 0.5 \text{ V}, f = 1 \text{ MHz}$		5.5	8.0	pF	TO-18
NF	$V_{CE} = 5 \text{ V}, I_C = 100 \mu\text{A}, R_S = 1 \text{ k}\Omega,$ $P_{BW} = 15.7 \text{ kHz}$		2.0	5.0	dB	
$h_{fe}$	$I_C = 10 \text{ mA}, V_{CE} = 20 \text{ V}, f = 100 \text{ MHz}$	2.0	5.0	7.0		
$h_{FE}$	$I_C = 100 \mu\text{A}, V_{CE} = 5 \text{ V}$	40	100	300		
$h_{FE}$	$I_C = 1 \text{ mA}, V_{CE} = 5 \text{ V}$	70	150	300		
$h_{FE}$	$I_C = 10 \text{ mA}, V_{CE} = 5 \text{ V}$	50	150	350		
$h_{FE}$	$I_C = 50 \text{ mA}, V_{CE} = 5 \text{ V}$	30	120	200		
$h_{FE}$	$I_C = 100 \text{ mA}, V_{CE} = 5 \text{ V}$	20	50	100		
$V_{CE(SAT)}$	$I_C = 10 \text{ mA}, I_B = 1 \text{ mA}$		0.07	0.10	V	
$V_{BE(SAT)}$	$I_C = 10 \text{ mA}, I_B = 1 \text{ mA}$		0.70	0.80	V	
$V_{CE(SAT)}$	$I_C = 50 \text{ mA}, I_B = 5 \text{ mA}$		0.10	0.15	V	
$V_{BE(SAT)}$	$I_C = 50 \text{ mA}, I_B = 5 \text{ mA}$		0.75	0.85	V	
$BV_{CBO}$	$I_C = 10 \mu\text{A}$	60	90	120	V	
$BV_{CEO}$	$I_C = 1 \text{ mA}$	30	40	50	V	
$BV_{EBO}$	$I_C = 10 \mu\text{A}$	6.0		8.0	V	
$I_{CBO}$	$V_{CB} = 25 \text{ V}$			50	nA	
$I_{EBO}$	$V_{EB} = 4 \text{ V}$			50	nA	

Pulsed DC Current Gain vs Collector Current

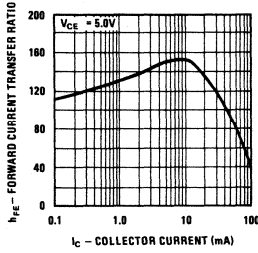

Base-Emitter On Voltage vs Collector Current

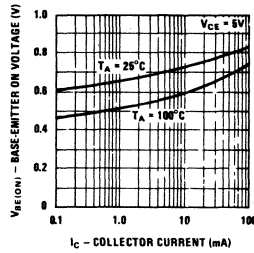

Maximum Power Dissipation vs Ambient Temperature

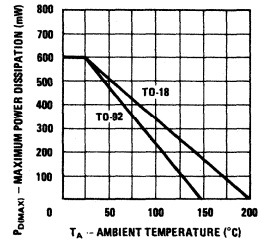

Maximum Power Dissipation vs Case Temperature

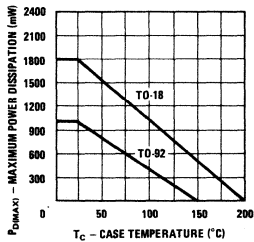

VCE(SAT) vs IC

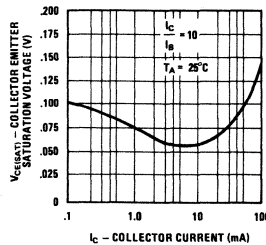

VBE(SAT) vs IC

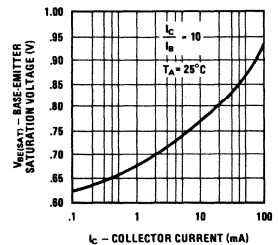

Capacitance vs Reverse Bias Voltage

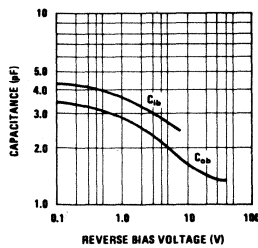

Collector Cutoff Current vs Ambient Temperature

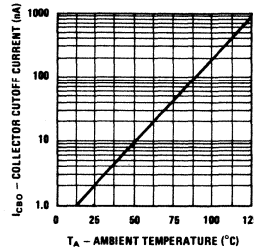

Current Gain and Phase Angle vs Frequency

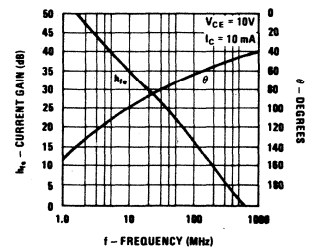

Noise Figure vs Frequency

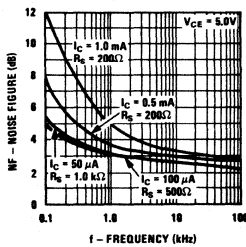

Noise Figure vs Source Resistance

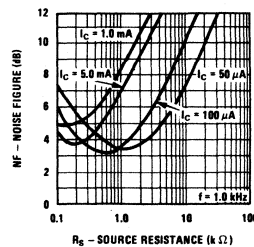

Contours of Constant Gain Bandwidth Product (fT)

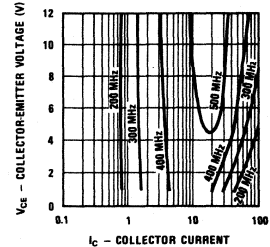

# Process 23

**h PARAMETERS** ( $V_{CE} = 10 V_{DC}$ ,  $f = 1.0 \text{ kHz}$ ,  $T_A = 25^\circ\text{C}$ )

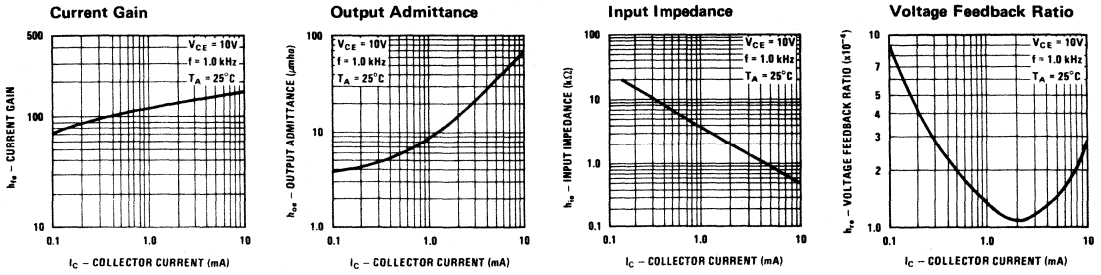

### Charge Data

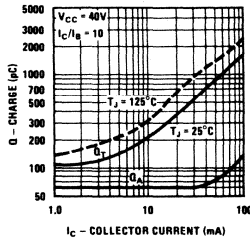

### Turn On Time

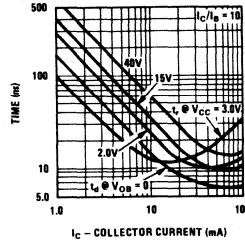

### Rise Time

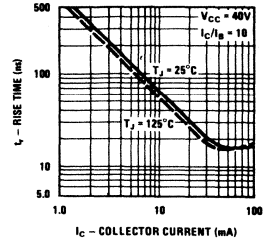

### Storage Time

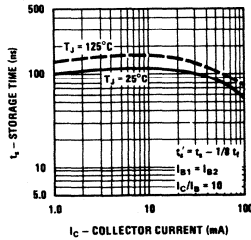

### Fall Time

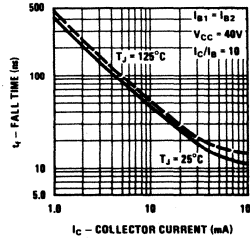

## TRANSIENT CHARACTERISTICS ( $-T_J = 25^\circ\text{C} \dots T_J = 125^\circ\text{C}$ )

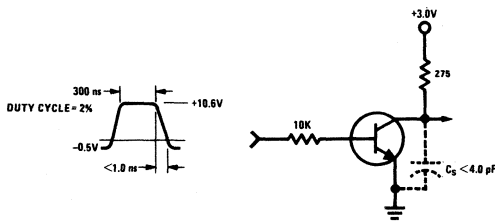

FIGURE 1. Delay and Rise Time Equivalent Test Circuit

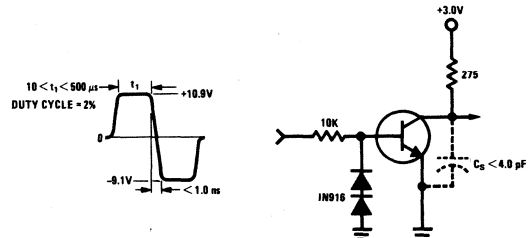
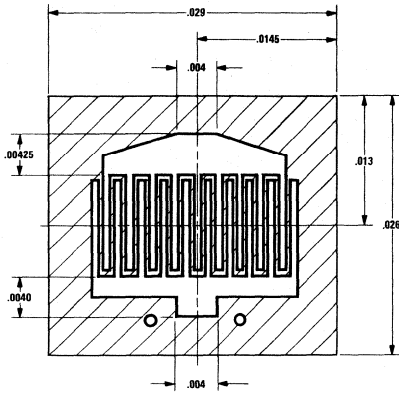

FIGURE 2. Storage and Fall Time Equivalent Test Circuit



## DESCRIPTION

Process 25 is an overlay double diffused, gold doped silicon epitaxial device. Complement to Process 70.

## APPLICATION

This device was designed for high speed core driver applications.

## PRINCIPAL DEVICE TYPES

TO-18	2N4014
TO-39	2N3725
TO-92+	TN3725

PARAMETER	TEST CONDITIONS	MIN	TYP	MAX	UNITS	NOTES
$t_{on}$	$I_C = 500 \text{ mA}, I_{B1} = 50 \text{ mA}$		12	35	ns	Fig. 1
$t_{off}$	$I_C = 500 \text{ mA}, I_{B2} = 50 \text{ mA}$		50	60	ns	Fig. 1
$h_{fe}$	$I_C = 50 \text{ mA}, V_{CE} = 10\text{V}, f = 100 \text{ MHz}$	2.5	4.25			
$C_{cb}$	$V_{CB} = 10\text{V}$		5.5	10	pF	
$C_{eb}$	$V_{EB} = 0.5\text{V}$		45	55	pF	
$h_{fe}$	$I_C = 10 \text{ mA}, V_{CE} = 1\text{V}$	40	60	120		
$h_{fe}$	$I_C = 100 \text{ mA}, V_{CE} = 1\text{V}$	45	90	150		
$h_{fe}$	$I_C = 300 \text{ mA}, V_{CE} = 1\text{V}$	35	65	120		
$h_{fe}$	$I_C = 500 \text{ mA}, V_{CE} = 1\text{V}$	25	50	100		
$h_{fe}$	$I_C = 800 \text{ mA}, V_{CE} = 1\text{V}$	20	28	40		
$h_{fe}$	$I_C = 1\text{A}, V_{CE} = 1\text{V}$	15	25	35		
$h_{fe}$	$I_C = 800 \text{ mA}, V_{CE} = 2\text{V}$	25	38	60		
$h_{fe}$	$I_C = 1\text{A}, V_{CE} = 5\text{V}$	25	40	60		
$V_{CE(SAT)}$	$I_C = 10 \text{ mA}, I_B = 1 \text{ mA}$		0.155	0.20	V	
$V_{CE(SAT)}$	$I_C = 100 \text{ mA}, I_B = 10 \text{ mA}$		0.155	0.20	V	
$V_{CE(SAT)}$	$I_C = 300 \text{ mA}, I_B = 30 \text{ mA}$		0.240	0.40	V	
$V_{CE(SAT)}$	$I_C = 500 \text{ mA}, I_B = 50 \text{ mA}$		0.350	0.50	V	
$V_{CE(SAT)}$	$I_C = 800 \text{ mA}, 80 \text{ mA}$		0.50	0.80	V	
$V_{CE(SAT)}$	$I_C = 1\text{A}, I_B = 100 \text{ mA}$		0.70	1.20	V	
$V_{BE(SAT)}$	$I_C = 10 \text{ mA}, I_B = 1 \text{ mA}$		0.66	0.70	V	
$V_{BE(SAT)}$	$I_C = 100 \text{ mA}, I_B = 10 \text{ mA}$		0.77	0.85	V	
$V_{BE(SAT)}$	$I_C = 300 \text{ mA}, I_B = 30 \text{ mA}$		0.88	1.20	V	
$V_{BE(SAT)}$	$I_C = 500 \text{ mA}, I_B = 50 \text{ mA}$		0.95	1.20	V	
$V_{BE(SAT)}$	$I_C = 800 \text{ mA}, I_B = 80 \text{ mA}$		1.10	1.50	V	
$V_{BE(SAT)}$	$I_C = 1\text{A}, I_B = 100 \text{ mA}$		1.18	1.70	V	
$BV_{CEO}$	$I_C = 10 \text{ mA}$	40	45	50	V	
$BV_{CBO}$	$I_C = 100 \mu\text{A}$	80	100	130	V	
$BV_{EBO}$	$I_C = 10 \mu\text{A}$	6.0			V	
$I_{CBO}$	$V_{CB} = 40\text{V}$			1.0	$\mu\text{A}$	
$I_{EBO}$	$V_{EB} = 4\text{V}$			1.0	$\mu\text{A}$	



# Process 25

**DC Pulse Current Gain vs Collector Current**

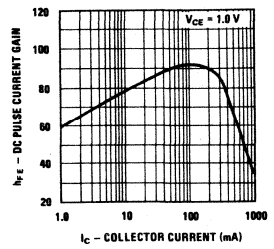

**Base-Emitter On Voltage vs Collector Current**

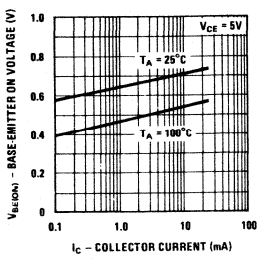

**Base Saturation Voltage vs Collector Current**

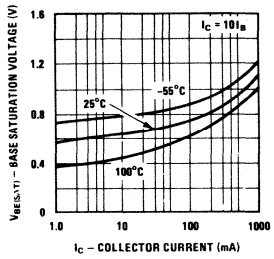

**Collector Saturation Voltage vs Collector Current**

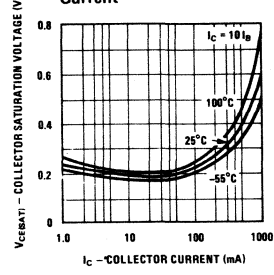

**Collector Cutoff Current vs Ambient Temperature**

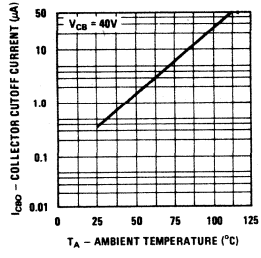

**Collector Cutoff Current vs Reverse Bias Voltage**

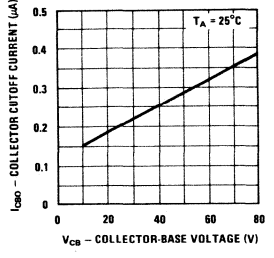

**Input and Output Capacitance vs Reverse Bias**

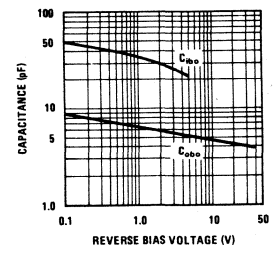

**Contours of Constant Bandwidth Product (fT)**

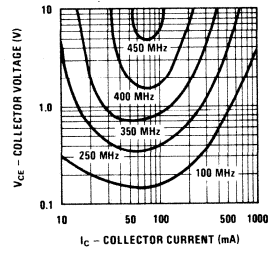

**Turn On and Turn Off Times vs Collector Current**

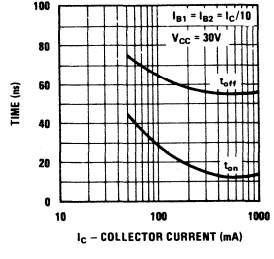

**Maximum Power Dissipation vs Ambient Temperature**

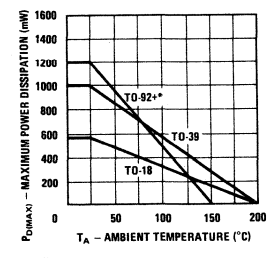

**Maximum Power Dissipation vs Case Temperature**

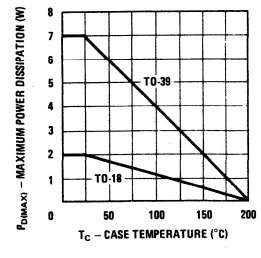

**Switching Times vs Ambient Temperature**

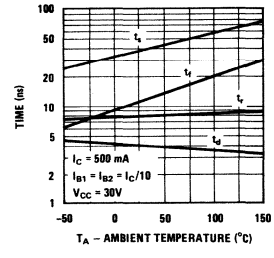

\* One square inch of copper run

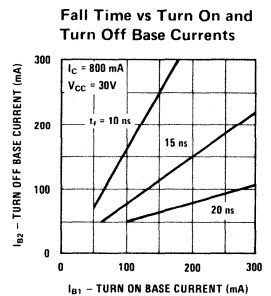
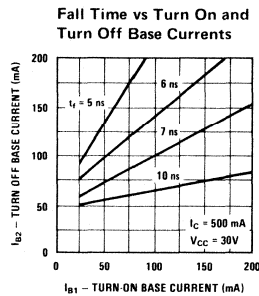
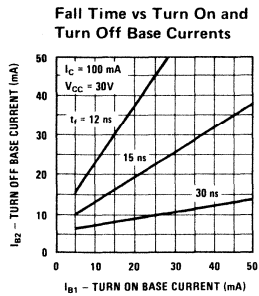
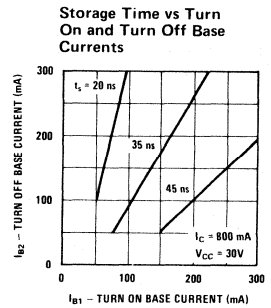
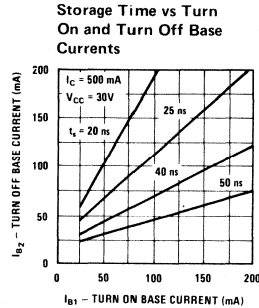
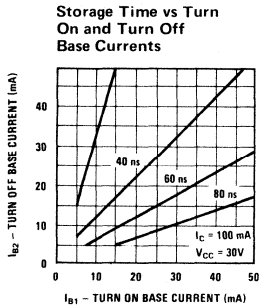
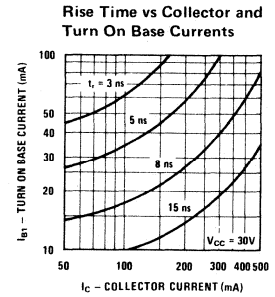
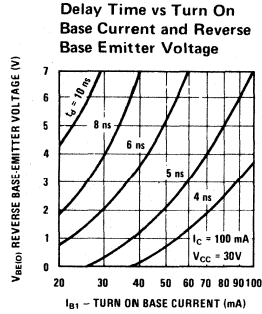
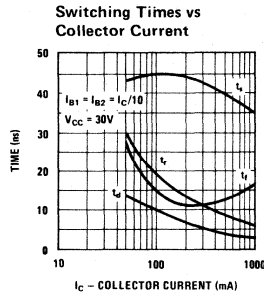

SWITCHING TIME TEST CIRCUIT

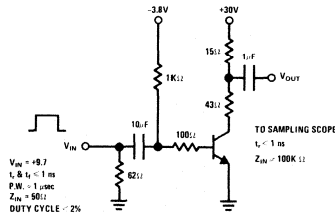
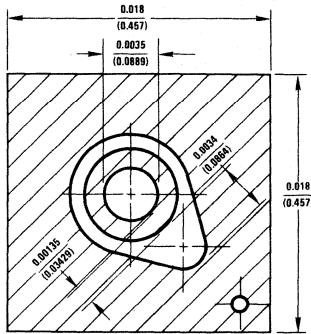

FIGURE 1.  $I_C \approx 500 mA$ ,  $I_{B1} \approx 50 mA$ ,  $I_{B2} \approx -50 mA$

**DESCRIPTION**

Process 27 is a nonoverlay, double diffused, silicon epitaxial device. Complement to Process 69.

**APPLICATION**

This device is designed for general purpose amplifier and switch applications, useful from audio to RF frequencies.

**PRINCIPAL DEVICE TYPES**

TO-18	2N915
TO-92	MPSA20 (EBC)

PARAMETER	TEST CONDITIONS	MIN	TYP	MAX	UNITS	NOTES
NF (wide band)	$V_{CE} = 5, I_C = 100 \mu A, f_{BW} = 15.7 \text{ kHz}$		1.5		dB	
NF (spot)	$V_{CE} = 5V, I_C = 100 \mu A, f = 1 \text{ kHz}$ $R_S = 1k$		1.5	3.0	dB	
$C_{cb}$	$V_{CB} = 10V, f = 1 \text{ MHz}$		2.0	2.5	pF	TO-18
$C_{ob}$	$V_{CB} = 10V, f = 1 \text{ MHz}$		2.5	3.0	pF	TO-18
$C_{ib}$	$V_{EB} = 0.50V, f = 1 \text{ MHz}$		5.5	7.0	pF	TO-18
$f_T$	$V_{CE} = 10V, I_C = 10 \text{ mA}$	100	500		MHz	
$t_{on}$	$V_{CE} = 10V, I_C = 10 \text{ mA}, I_{B1} = 1 \text{ mA}$	30	40	50	ns	
$t_{off}$	$V_{CE} = 10V, I_C = 10 \text{ mA}, I_{B2} = 1 \text{ mA}$	400	600	700	ns	
$h_{FE}$	$V_{CE} = 10V, I_C = 100 \mu A$	40	115	340		
$h_{FE}$	$V_{CE} = 10V, I_C = 1 \text{ mA}$	50	150	450		
$h_{FE}$	$V_{CE} = 10V, I_C = 10 \text{ mA}$	62	185	560		
$h_{FE}$	$V_{CE} = 10V, I_C = 50 \text{ mA}$	45	130	400		
$V_{CE(SAT)}$	$I_C = 10 \text{ mA}, I_B = 1 \text{ mA}$		0.055	0.10	V	
$V_{BE(SAT)}$	$I_C = 10 \text{ mA}, I_B = 1 \text{ mA}$		0.770	1.0	V	
$BV_{CBO}$	$I_C = 100 \mu A$	50	70		V	
$BV_{CEO}$	$I_C = 10 \text{ mA}$	30	45	60	V	
$BV_{EBO}$	$I_E = 10 \mu A$	5.0	6.5		V	
$I_{CBO}$	$V_{CB} = 40$			50	nA	
$I_{EBO}$	$V_{EB} = 4.0$			50	nA	

**DC Pulse Current Gain vs Collector Current**

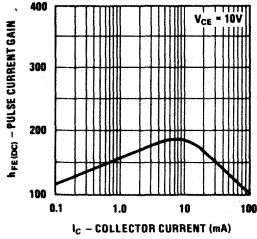

**Base-Emitter On Voltage vs Collector Current**

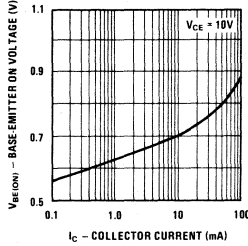

**Maximum Power Dissipation vs Ambient Temperature**

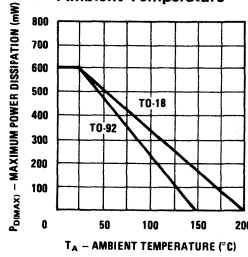

**Maximum Power Dissipation vs Case Temperature**

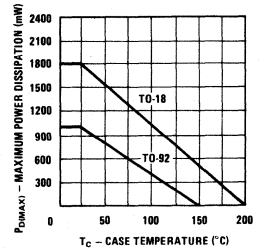

**Collector-Emitter Saturation Voltage vs Collector Current**

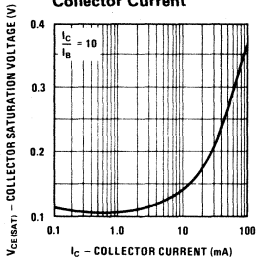

**Rb'Cc vs Collector Current**

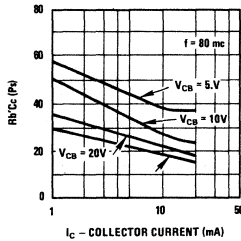

**Small Signal Current Gain vs Collector Current**

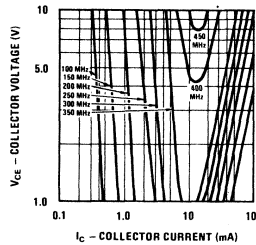

**Small Signal Current Gain vs Frequency**

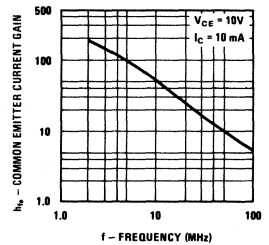

**Base Saturation Voltage vs Collector Current**

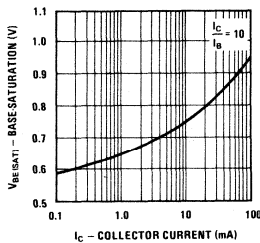

**tON And tOFF vs Collector Current**

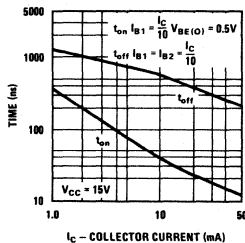

**Switching Times vs Collector Current**

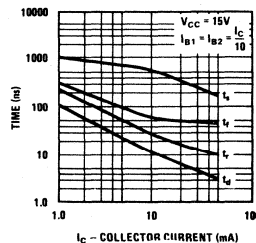

**Noise Figure vs Frequency**

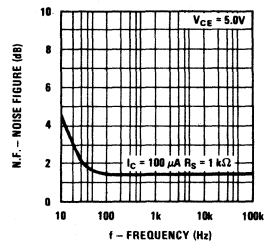

Noise Figure vs Source Resistance

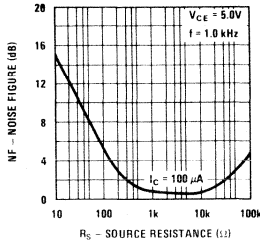

Noise Figure vs Collector Current

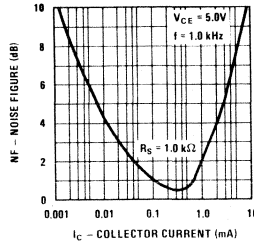

COMMON EMITTER Y PARAMETERS

Input Admittance vs Collector Current

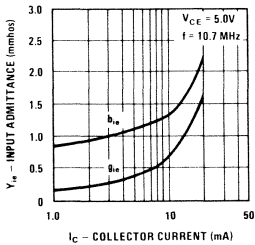

Output Admittance vs Collector Current

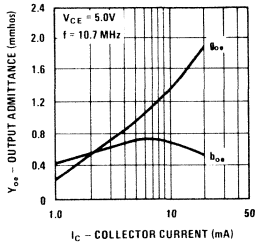

Forward Transfer Admittance vs Collector Current

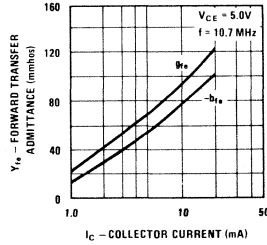

Reverse Transfer Admittance vs Collector Current

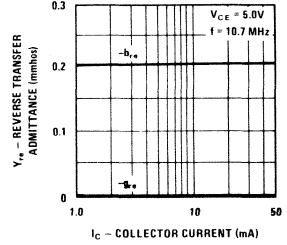

COMMON EMITTER H PARAMETERS

Small Signal Input Resistance vs Collector Current

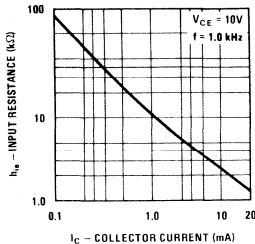

Small Signal Output Conductance vs Collector Current

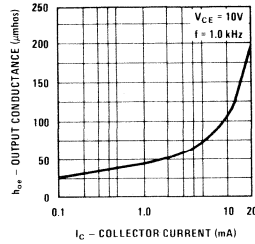

Small Signal Current Gain vs Collector Current

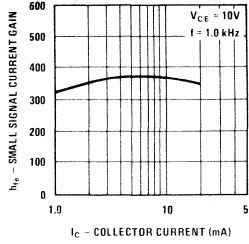

Small Signal Voltage Feedback Ratio vs Collector Current

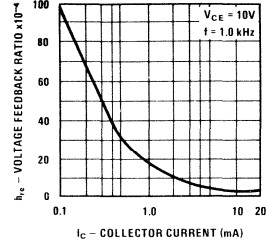

**DESCRIPTION**

Process 29 is an overlay double diffused, silicon epitaxial device.

**APPLICATION**

This device was designed for use in high frequency receiver front end designs requiring good NF from low driving  $R_s$ .

**PRINCIPAL DEVICE TYPES**

TO-92-MPS

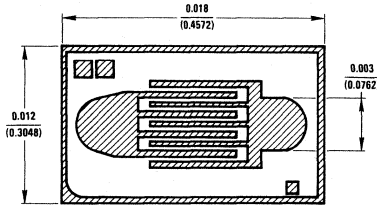

PARAMETER	TEST CONDITIONS	MIN	TYP	MAX	UNITS
$BV_{CEO}$	$I_C = 1 \text{ mA}$	80			V
$BV_{CBO}$	$I_C = 100 \mu\text{A}$	80			V
$BV_{EBO}$	$I_E = 100 \mu\text{A}$	4.0			V
$I_{CBO}$	$V_{CB} = 60\text{V}$			50	nA
$I_{EBO}$	$V_{EB} = 3.0\text{V}$			50	nA
HFE	$V_{CE} = 10\text{V}, I_C = 1.5 \text{ mA}$	30	70	150	
$V_{CE(SAT)}$	$I_C = 10 \text{ mA}, I_B = 1 \text{ mA}$		0.12	0.25	V
$f_t$	$V_{CE} = 10\text{V}, I_C = 1.5 \text{ mA}, f = 100 \text{ MHz}$	80	180		MHz
$C_{cb}$	$V_{CB} = 10\text{V}$		1.0	1.6	pF
$h_{oe}$	$I_C = 1.5 \text{ mA}, V_{CE} = 10\text{V}, f = 1.0 \text{ kHz}$		2.0	5.0	$\mu\text{mho}$
NF	$I_C = 1.5 \text{ mA}, V_{CE} = 10\text{V}, R_s = 50\Omega, f = 1.0 \text{ MHz}$		1.7	2.0	dB

$V_{CE} = 10V, T_A = 25^\circ C$  unless otherwise noted

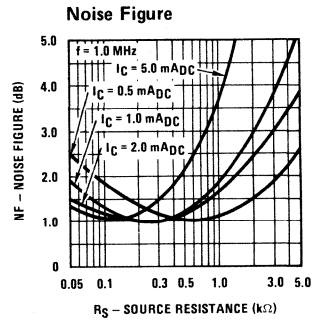
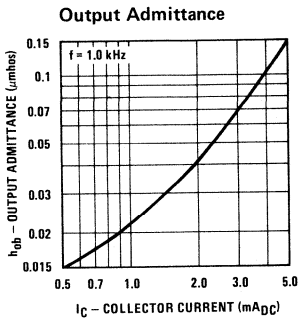
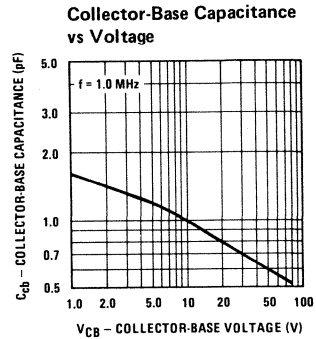
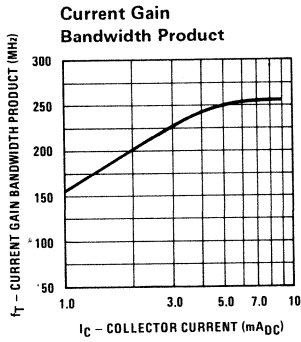
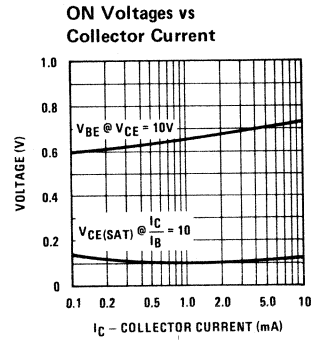
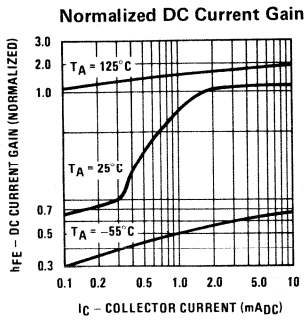

## DESCRIPTION

Process 35 is a double diffused silicon epitaxial device.

## APPLICATION

This device is designed for use in the output stage of 4W AM Citizens Band (27 MHz) transmitters with capabilities to withstand infinite VSWR at rated output.

## PRINCIPAL DEVICE TYPES

TO-39	MRF8004
TO-126	MRF472
TO-220	2SC1678

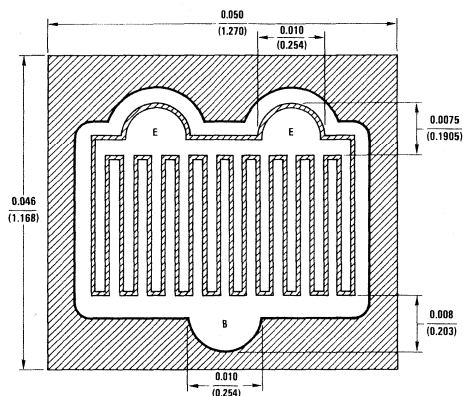

PARAMETER	TEST CONDITIONS	MIN	TYP	MAX	UNITS
$P_{OUT}$	$f = 27 \text{ MHz}$ , $I_C (\text{Avg}) = 415 \text{ mA}$ , (Figure 1)	3.0	3.5		W
$\eta$	$V_{CC} = 12\text{V}$ , $P_{IN} = 0.4\text{W}$	60	70		%
$h_{fe}$	$I_C = 100 \text{ mA}$ , $V_{CE} = 5\text{V}$ , $f = 20 \text{ MHz}$	6.0	12		
$C_{ob}$	$V_{CB} = 10\text{V}$		25	35	pF
$H_{FE}$	$I_C = 100 \text{ mA}$ , $V_{CE} = 1\text{V}$	30	70	150	
$V_{CES}$	$I_C = 1.0\text{A}$ , $I_B = 100 \text{ mA}$		0.2	0.5	V
$BV_{CER}$	$I_C = 1 \text{ mA}$ , $R_{BE} = 10\Omega$	65			V
$BV_{EBO}$	$I_E = 100 \mu\text{A}$	3			V
$I_{CBO}$	$V_{CB} = 40\text{V}$			10	$\mu\text{A}$
$I_{CEO}$	$V_{CE} = 40\text{V}'$			100	$\mu\text{A}$
$I_{EBO}$	$V_{EB} = 2.0\text{V}$			10	$\mu\text{A}$
SOA	$V_{CE} = 30\text{V}$ , $t = 1 \text{ sec}$	500			mA

Safe Operating Area Curve

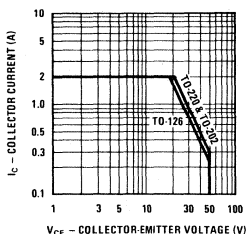

Safe Operating Area Curve

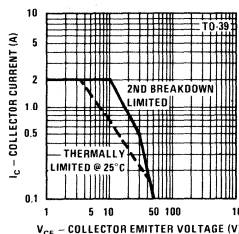



# Process 35

**Base-Emitter Saturation Voltage vs Collector Current**

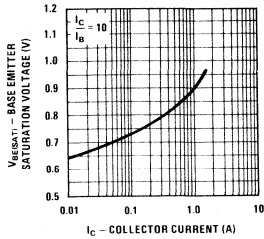

**DC Current Gain vs Collector Current**

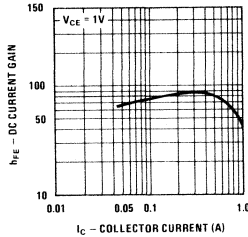

**Collector-Emitter Saturation Voltage vs Collector Current**

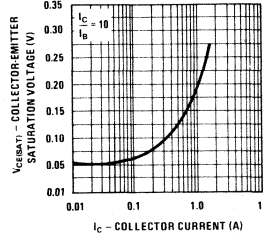

**I\_C vs V\_CE**

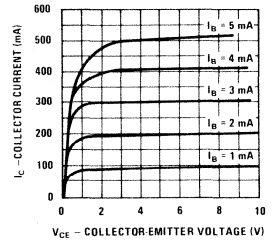

**Contours of Constant Gain Bandwidth Product (f<sub>T</sub>)**

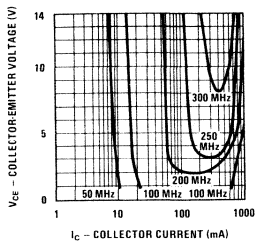

**f<sub>T</sub> vs I\_C**

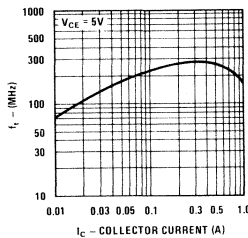

**Power In vs Power Out**

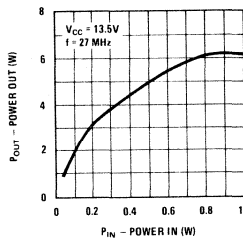

**Maximum Power Dissipation vs Case Temperature**

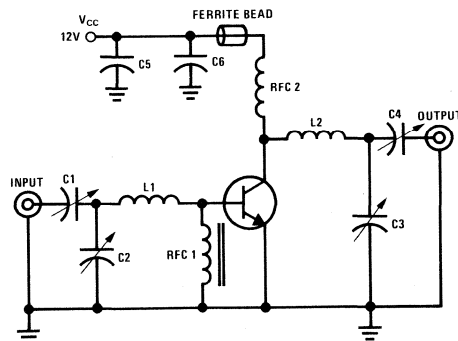
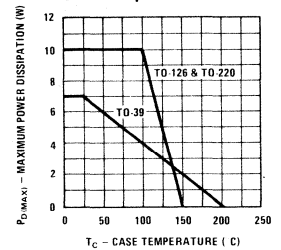

- C1, C2 - 9.0 - 180 pF ARCO 463
- C3, C4 - 5.0 - 80 pF ARCO 462
- C5 = 0.01 μF Disc
- C6 = 0.1 μF Disc
- RFC 1 4 turns No. 32 enameled wire wound on Indiana General Bead No. 57-1692
- RFC 2 15 μH choke, J.W. Miller #4624
- L1 - 0.22 μH molded choke
- L2 - 1 μH molded choke

FIGURE 1. 27 MHz Test Circuit

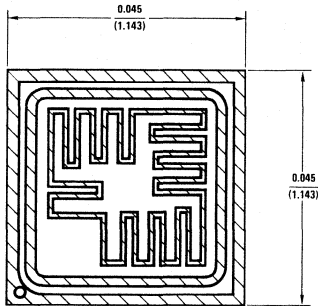

**DESCRIPTION**

Process 36 a non-overlay double-diffused silicon epitaxial device.

**APPLICATION**

This device is designed for use in horizontal driver, class A off-line amplifier and off-line switching applications.

**PRINCIPAL DEVICE TYPES**

- 2N5655    MJE340    MJE343
- 2N5656    MJE341    MJE344
- 2N5657    MJE342

PARAMETER	CONDITIONS	MIN	TYP	MAX	UNITS
BV <sub>CEO</sub>	I <sub>CE</sub> = 1 mA*	200	300		V
BV <sub>CBO</sub>	I <sub>CB</sub> = 100 μA	225	325		V
BV <sub>EBO</sub>	I <sub>EB</sub> = 10 μA	6			V
I <sub>CEO</sub>	V <sub>CE</sub> = 200V			50	μA
I <sub>CBO</sub>	V <sub>CB</sub> = 225V			1	μA
I <sub>EBO</sub>	V <sub>EB</sub> = 5V			1	μA
H <sub>FE</sub>	I <sub>C</sub> = 50 mA, V <sub>CE</sub> = 10V*	25	190		
	I <sub>C</sub> = 100 mA, V <sub>CE</sub> = 10V*	30	200	300	
	I <sub>C</sub> = 250 mA, V <sub>CE</sub> = 10V*	15	60		
	I <sub>C</sub> = 500 mA, V <sub>CE</sub> = 10V*	10	25		
V <sub>CE(SAT)</sub>	I <sub>C</sub> = 100 mA, I <sub>B</sub> = 10 mA*		0.08	0.5	V
V <sub>CE(SAT)</sub>	I <sub>C</sub> = 500 mA, I <sub>B</sub> = 100 mA*		0.175	0.5	V
V <sub>BE(SAT)</sub>	I <sub>C</sub> = 500 mA, I <sub>B</sub> = 100 mA*		0.9	1.2	V
V <sub>BE(ON)</sub>	I <sub>C</sub> = 100 mA, V <sub>CE</sub> = 10V*		0.7	1.0	V
f <sub>t</sub>	I <sub>C</sub> = 50 mA, V <sub>CE</sub> = 10V, f = 20 MHz	10	60		MHz
C <sub>ob</sub>	V <sub>CB</sub> = 10V			15	pF
C <sub>ib</sub>	V <sub>BE</sub> = 0.5V			125	pF
I <sub>SB</sub>	V <sub>CE</sub> = 100V, T = 1 second	200			mA
PD(MAX)	TO-126			25	W
	TO-202			15	W
θ <sub>jc</sub>	TO-126			5.0	°C/W
	TO-202			8.33	°C/W
θ <sub>JA</sub>	TO-202			69.4	°C/W

\*Pulse test, pulse width = 300 μs

Typical Normalized Pulsed Current Gain vs Collector Current

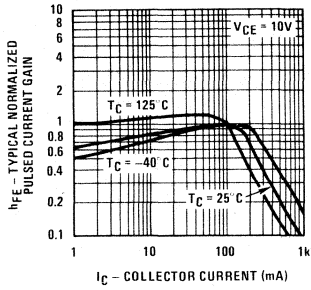

Collector-Emitter Saturation Voltage vs Collector Current

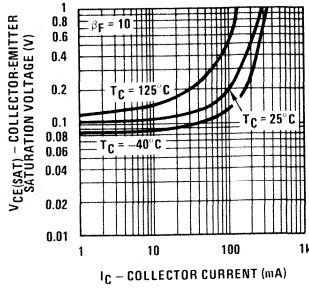

Base-Emitter Saturation Voltage vs Collector Current

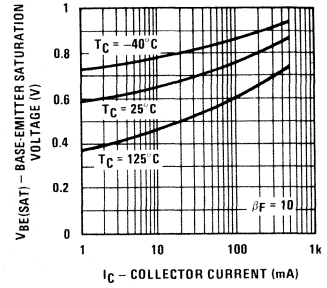

Base-Emitter ON Voltage vs Collector Current

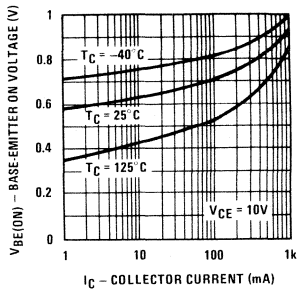

Contours of Constant Gain Bandwidth Product (f<sub>T</sub>)

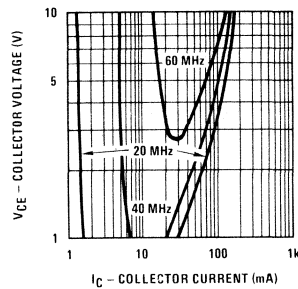

Collector-Base and Emitter-Base Capacitance vs Reverse Bias Voltage

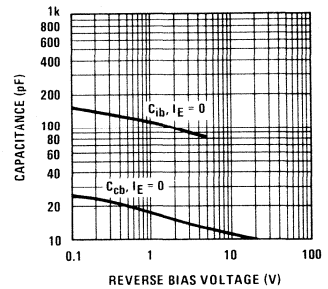

Typical Switching Time vs Collector Current

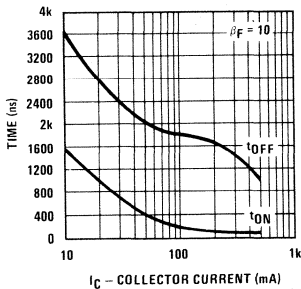

Safe Operating Area TO-126

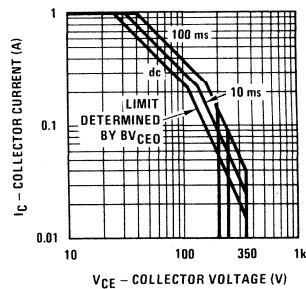

Safe Operating Area TO-202

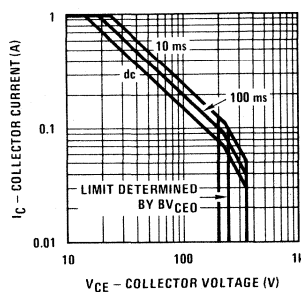

Maximum Power Dissipation vs Case Temperature

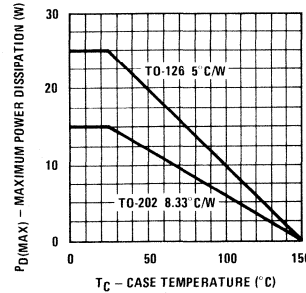

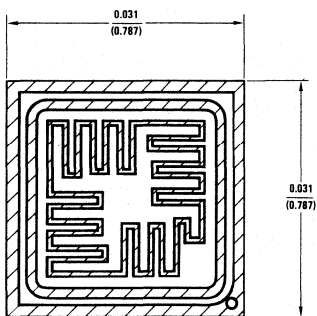

## DESCRIPTION

Process 37 is a double diffused silicon epitaxial planar device. Complement to Process 77.

## APPLICATION

This device was designed for general purpose medium power amplifiers and switching circuits that require collector currents to 1A.

PARAMETER	TEST CONDITIONS	MIN	TYP	MAX	UNITS
$BV_{CEO}$	$I_C = 10 \text{ mA}$	25		45	V
$BV_{CBO}$	$I_C = 100\mu\text{A}$	50			V
$BV_{EBO}$	$I_E = 100\mu\text{A}$	5	7		V
$I_{CBO}$	$V_{CB} = BV_{CEO}$		50	500	nA
$I_{EBO}$	$V_{EB} = 5V$		0.1	100	$\mu\text{A}$
$h_{FE}$	$I_C = 500 \text{ mA}, V_{CE} = 1V$	100		400	
$V_{CE(SAT)}$	$I_C = 1A, I_B = 0.1A$		0.2	0.5	V
$V_{BE(SAT)}$	$I_C = 1A, I_B = 0.1A$		0.95	1.5	V
$f_T$	$I_C = 100 \text{ mA}, V_{CE} = 10V$		300		MHz
$C_{OBO}$	$V_{CB} = 10V$			20	pF

## PRINCIPAL DEVICE TYPES

**TO-202 (Package 35)**    **92 PLUS (Package 91)**

NSD102                    92PU01  
NSD103                    92PU01A

NSDU01  
NSDU01A                **TO-126 (Package 38)**  
BD135

**TO-202 (Package 36)**

D42C1  
D42C2  
D42C3  
D42C4  
D42C5  
D42C6  
NSE180

**92 PLUS (Package 90)**

92PE37A  
BD373A

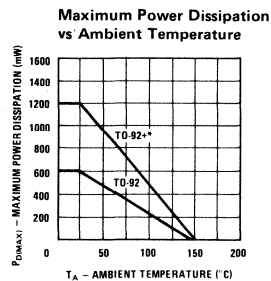
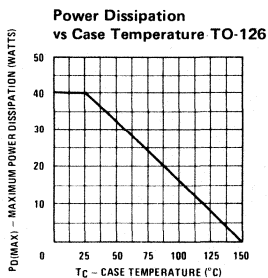

\*One square inch of copper run

Typical Normalized Pulsed Current Gain vs Collector Current

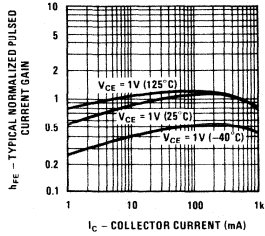

Typical Normalized Pulsed Current Gain vs Collector Current

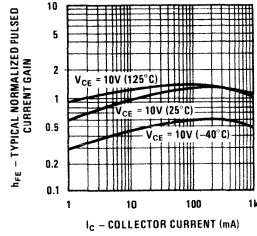

Base-Emitter "ON" Voltage vs Collector Current

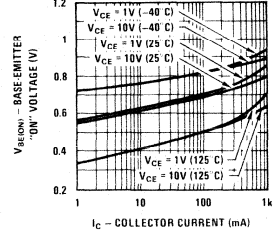

Base-Emitter Saturation Voltage vs Collector Current

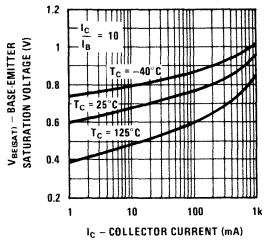

Collector-Emitter Voltage vs Collector Current

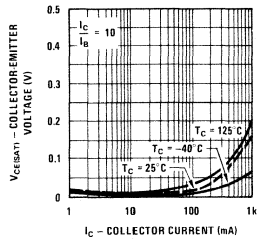

Gain Bandwidth Product vs Collector Current

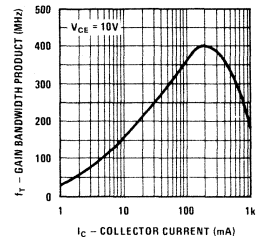

Collector-Base Capacitance vs Collector-Base Voltage

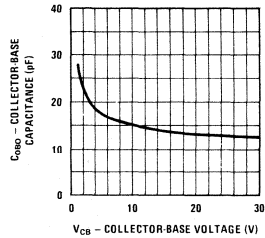

Safe Operating Area TO-202

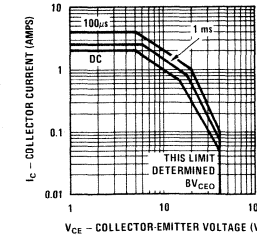

Maximum Power Dissipation vs Ambient Temperature (TO-202)

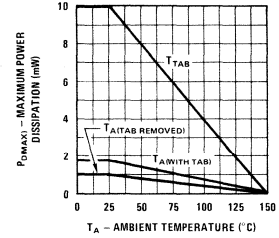

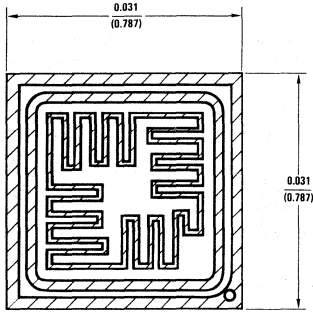

## DESCRIPTION

Process 38 is a double diffused silicon epitaxial planar device. Complement to Process 78.

## APPLICATION

This device was designed for general purpose medium power amplifier and switching circuits that require collector currents to 1A.

PARAMETER	TEST CONDITIONS	MIN	TYP	MAX	UNITS
$V_{CEO}$	$I_C = 10 \text{ mA}$	45		80	V
$V_{CBO}$	$I_C = 100 \mu\text{A}$	90		160	V
$V_{EBO}$	$I_E = 100 \mu\text{A}$	5	7		V
$I_{CBO}$	$V_{CB} = V_{CEO}$		50	500	nA
$I_{EBO}$	$V_{EB} = 5 \text{ V}$		0.1	100	$\mu\text{A}$
$h_{FE}$	$I_C = 100 \text{ mA}, V_{CE} = 1 \text{ V}$	150		500	
$V_{CE(SAT)}$	$I_C = 500 \text{ mA}, I_B = 50 \text{ mA}$		0.2	0.5	V
$V_{BE(SAT)}$	$I_C = 500 \text{ mA}, I_B = 50 \text{ mA}$		0.8	1.4	V
$f_T$	$I_C = 100 \text{ mA}, V_{CE} = 10 \text{ V}$		250		MHz
$C_{OBO}$	$V_{CB} = 10 \text{ V}$			15	pF

## PRINCIPAL DEVICE TYPES

**TO-202 (Package 35)**    **92 PLUS (Package 91)**

NSDU05                    92PU05  
 NSD6178                BD371B  
 NSD6179                BD371C

**TO-202 (Package 36)**    **TO-126 (Package 38)**

D42C7                    BD137  
 D42C8  
 D42C9  
 NSE181

**92 PLUS (Package 90)**

92PE37B  
 BD373B  
 BD373C

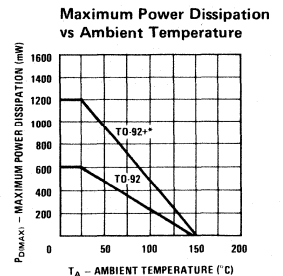
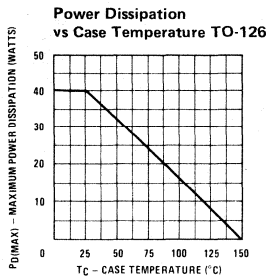

\*One square inch of copper run

Typical Normalized Pulsed Current Gain vs Collector Current

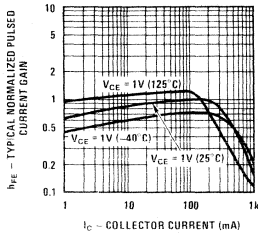

Typical Normalized Pulsed Current Gain vs Collector Current

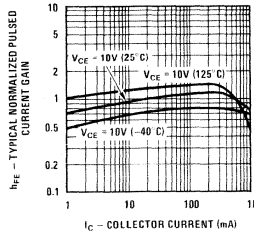

Base-Emitter "ON" Voltage vs Collector Current

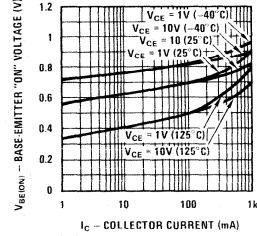

Base-Emitter Saturation Voltage vs Collector Current

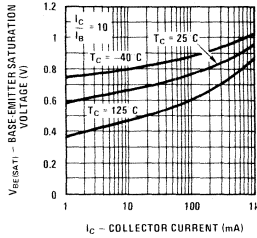

Collector-Emitter Saturation Voltage vs Collector Current

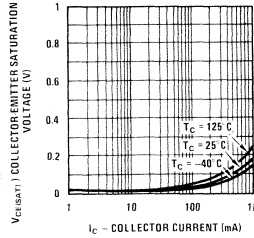

Gain Bandwidth Product vs Collector Current

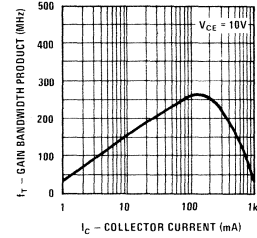

Collector-Base Capacitance vs Collector-Base Voltage

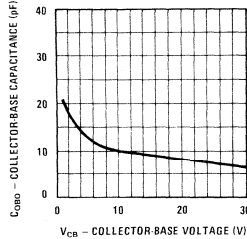

Safe Operating Area TO-202

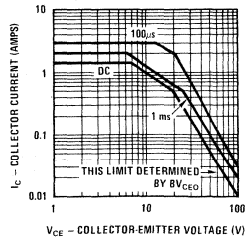

Maximum Power Dissipation vs Ambient Temperature (TO-202)

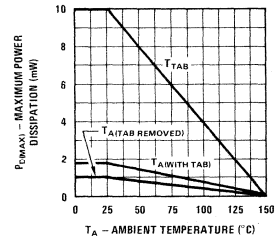

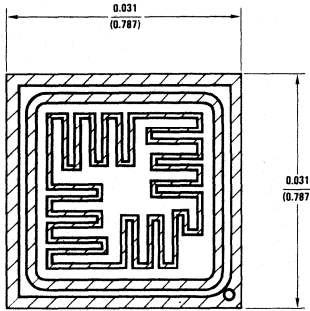

## DESCRIPTION

Process 39 is a double diffused silicon epitaxial planar device. Complement to Process 79.

## APPLICATION

This device was designed for general purpose medium power amplifier and switching circuits that require collector currents to 1A.

PARAMETER	TEST CONDITIONS	MIN	TYP	MAX	UNITS
$BV_{CEO}$	$I_C = 10 \text{ mA}$	80		110	V
$BV_{CBO}$	$I_C = 100 \mu\text{A}$	160		220	V
$BV_{EBO}$	$I_E = 100 \mu\text{A}$	5	7		V
$I_{CBO}$	$V_{CB} = BV_{CEO}$		50	500	nA
$I_{EBO}$	$V_{EB} = 5\text{V}$		0.1	100	$\mu\text{A}$
$h_{FE}$	$I_C = 100 \text{ mA}, V_{CE} = 1\text{V}$	100		350	
$V_{CE(SAT)}$	$I_C = 500 \text{ mA}, I_B = 50 \text{ mA}$		0.2	0.5	V
$V_{BE(SAT)}$	$I_C = 500 \text{ mA}, I_B = 50 \text{ mA}$		0.95	1.5	V
$f_T$	$I_C = 100 \text{ mA}, V_{CE} = 10\text{V}$		120		MHz
$C_{OBO}$	$V_{CB} = 10\text{V}$			12	pF

## PRINCIPAL DEVICE TYPES

### TO-202 (Package 35)

NSD104  
NSD105  
NSD106  
NSDU06  
NSDU07

### 92 PLUS (Package 90)

92PE37C  
BD373D

### 92 PLUS (Package 91)

92PU06  
92PU07  
BD371D

### TO-126 (Package 38)

BD139

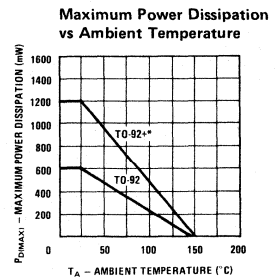
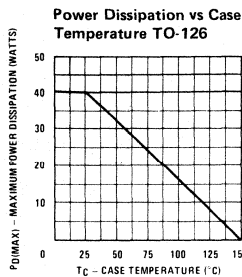

\*One square inch of copper run



**Typical Normalized Pulsed Current Gain vs Collector Current**

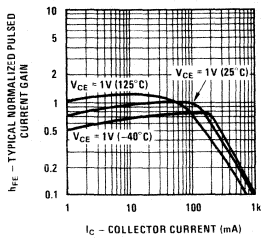

**Typical Normalized Pulsed Current Gain vs Collector Current**

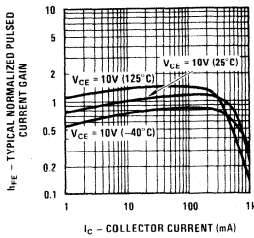

**Base-Emitter "ON" Voltage vs Collector Current**

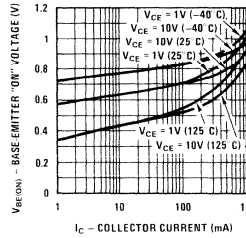

**Base-Emitter Saturation Voltage vs Collector Current**

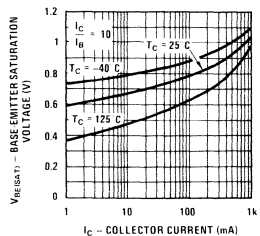

**Collector-Emitter Saturation Voltage vs Collector Current**

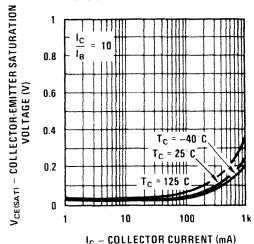

**Gain Bandwidth Product vs Collector Current**

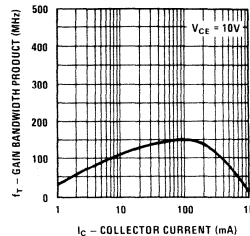

**Collector-Base Capacitance vs Collector-Base Voltage**

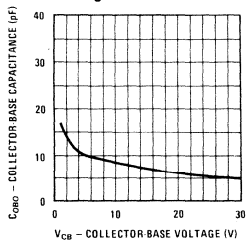

**Safe Operating Area TO-202**

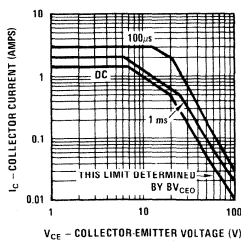

**Maximum Power Dissipation vs Ambient Temperature (TO-202)**

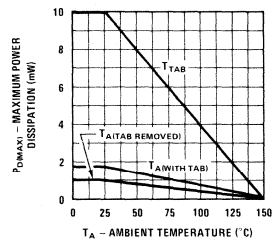

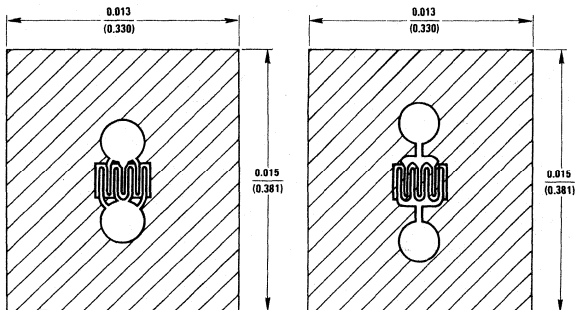

UHF (TO-72 and Micro Disc Only)

VHF (TO-92 Only)

## DESCRIPTION

Process 41 is an overlay double diffused, silicon device.

## APPLICATION

This device was designed for use in extremely low noise UHF/VHF preamplifiers operated common-emitter or common base, and in UHF mixers. Exhibits forward AGC characteristics between 3–10 mA.

PARAMETER	TEST CONDITIONS	MIN	TYP	MAX	UNITS	NOTES
NF	f = 800 MHz, $V_{CB} = 10V$ , $I_C = 2\text{ mA}$ , Common Base, $ Y_S  = \text{Optimum}$		5.5		dB	TO-72
NF	f = 800 MHz, $V_{CB} = 10V$ , $I_C = 2\text{ mA}$ , Common Base, $ Y_S  = 10 \pm j0\text{ mmhos}$		7.0	9.5	dB	TO-72
$P_G$	f = 800 MHz, $V_{CB} = 10V$ , $I_C = 2\text{ mA}$ , Common Base, $R_L = 500\Omega$	7.5	9.0		dB	TO-72
NF	f = 450 MHz, $V_{CE} = 10V$ , $I_C = 2\text{ mA}$ , Common-Emitter, $R_S = 75\Omega$		2.0		dB	TO-72
NF	f = 200 MHz, $V_{CB} = 10V$ , $I_C = 3\text{ mA}$ , Common Base, $R_S = 100\Omega$		2.5	3.0	dB	Fig. 1
$P_G$	f = 200 MHz, $V_{CB} = 10V$ , $I_C = 3\text{ mA}$ , Common Base, $R_L = 1\text{ k}\Omega$	13	16		dB	Fig. 1
$rb'C_c$	f = 79.8 MHz, $V_{CB} = 10V$ , $I_C = 3\text{ mA}$ ,		2.5	5.0	ps	TO-72
$h_{fe}$	f = 100 MHz, $V_{CE} = 10V$ , $I_C = 2\text{ mA}$	6.0	7.5			
$C_{cb}$	f = 1.0 MHz, $V_{CB} = 10V$ , $I_E = 0$		0.28	0.35	pF	TO-72
$C_{ce}$	f = 1.0 MHz, $V_{CE} = 10V$ , $I_B = 0$		0.12 0.19	0.20 0.30	pF	TO-72 TO-92
$h_{FE}$	$V_{CE} = 10V$ , $I_C = 2\text{ mA}$	30	75	200		
$BV_{CEO}$	$I_C = 1\text{ mA}$	30			V	
$BV_{CBO}$	$I_C = 10\mu\text{A}$	30			V	
$BV_{EBO}$	$I_E = 1\mu\text{A}$	3.0	4.0		V	
$I_{CBO}$	$V_{CB} = 20V$			100	nA	
$I_{EBO}$	$V_{EB} = 2.5V$			50	nA	

## PRINCIPAL DEVICE TYPES

### TO-72 (Package 25)

BF180  
BF181  
BF200

### TO-92 (Package 75)

MPSH08  
MPSH07

# Process 41

**DC Pulse Current Gain vs Collector Current**

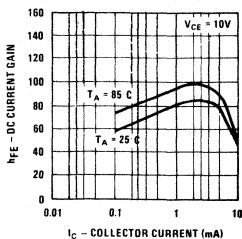

**Common Base Noise Figure vs Frequency @ Optimum Source  $|Y_S|$**

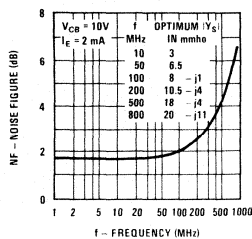

**Normalized Common Base Gain vs Emitter Current vs Operating Frequency**

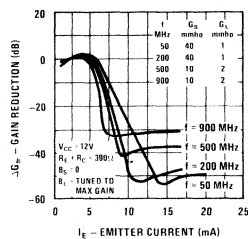

**Contours of Constant Gain Bandwidth Product ( $f_T$ )**

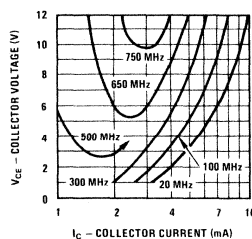

## COMMON BASE Y PARAMETERS VS FREQUENCY

**Input Admittance vs Frequency**

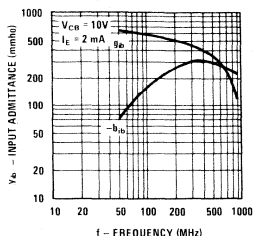

**Reverse Transfer Admittance vs Frequency**

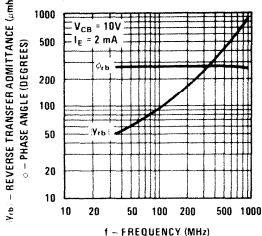

**Forward Transfer Admittance vs Frequency**

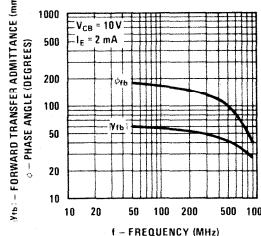

**Output Admittance vs Frequency**

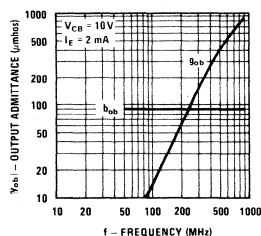

## CONTOURS OF CONSTANT NOISE FIGURES

**Common Base Noise Figure vs Source  $|Y_S|$**

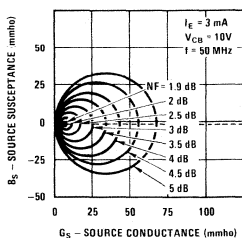

**Common Base Noise Figure vs Source  $|Y_S|$**

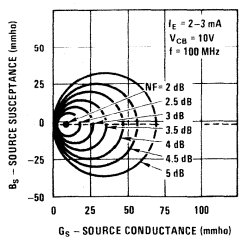

**Common Base Noise Figure vs Source  $|Y_S|$**

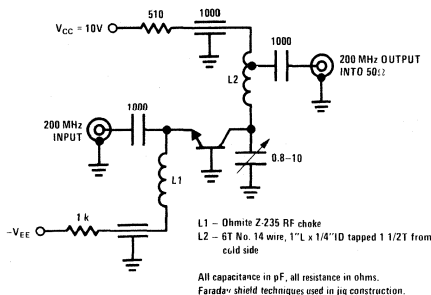
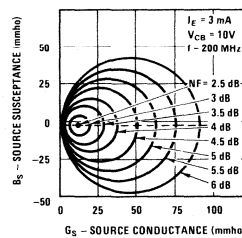

All capacitance in pF, all resistance in ohms.  
 Faraday shield techniques used in jig construction.

**FIGURE 1. Common Base 200 MHz PG and NF Circuit**

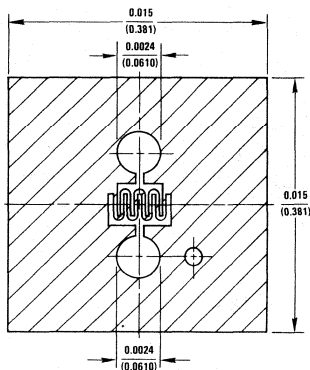

## DESCRIPTION

Process 42 is an overlay double diffused silicon epitaxial device.

## APPLICATION

This device was designed for use in low noise UHF/VHF amplifiers with collector current in the 100  $\mu$ A to 10 mA range in common emitter or common base mode of operation, and low frequency drift, high output UHF oscillators.

## PRINCIPAL DEVICE TYPES

TO-72            2N5179  
TO-92            2SC535 (ECB), MPS-H10 (BEC)

PARAMETER	TEST CONDITIONS	MIN	TYP	MAX	UNITS	NOTES
PG	$f = 450 \text{ MHz}, V_{CE} = 10\text{V}, I_C = 2 \text{ mA}$	10	13		dB	Fig. 1
NF	$f = 450 \text{ MHz}, V_{CE} = 10\text{V}, I_C = 2 \text{ mA}$ $R_g = 50\Omega$		3.0	5.0	dB	Fig. 1
$P_{OUT}$	$f = 500 \text{ MHz}, V_{CB} = 15\text{V}, I_E = 8 \text{ mA}$	30	50		mW	TO-92 Fig. 3
PG	$f = 200 \text{ MHz}, V_{CE} = 10\text{V}, I_C = 2 \text{ mA}$	22	27		dB	Fig. 2
NF	$f = 200 \text{ MHz}, V_{CE} = 10\text{V}, I_C = 2 \text{ mA}$ $R_S = 120\Omega$		2.0	3.5	dB	Fig. 2
$h_{fe}$	$f = 100 \text{ MHz}, V_{CE} = 10\text{V}, I_C = 5 \text{ mA}$	6.0	10.5	15		
$r_b' C_c$	$f = 79.8 \text{ MHz}, V_{CE} = 10\text{V}, I_C = 5 \text{ mA}$		3.5	10	ps	TO-72
$C_{cb}$	$f = 1.0 \text{ MHz}, V_{CB} = 10\text{V}, I_E = 0$		0.4	0.5	pF	TO-72
$C_{ce}$	$f = 1.0 \text{ MHz}, V_{CE} = 10\text{V}, I_B = 0$		0.2	0.3	pF	TO-72
$C_{eb}$	$f = 1.0 \text{ MHz}, V_{EB} = 0.5\text{V}, I_C = 0$		0.8	1.5	pF	TO-72
$h_{FE}$	$V_{CE} = 10\text{V}, I_C = 5 \text{ mA}$	30	90	200		
$h_{FE}$	$V_{CE} = 6\text{V}, I_C = 1 \text{ mA}$	25	75			
$V_{CE(SAT)}$	$I_C = 10 \text{ mA}, I_B = 5 \text{ mA}$		0.07	0.2	V	
$BV_{CEO}$	$I_C = 1 \text{ mA}$	20	30	40	V	
$BV_{CBO}$	$I_C = 100 \mu\text{A}$	35			V	
$BV_{EBO}$	$I_E = 10 \mu\text{A}$	4.0			V	
$I_{CBO}$	$V_{CB} = 30\text{V}$			100	nA	
$I_{EBO}$	$V_{EB} = 3\text{V}$			50	nA	

# Process 42

DC Pulse Current Gain vs Collector Current

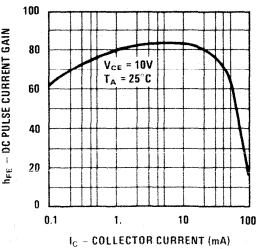

Contours Of Constant Gain Bandwidth Product (fT)

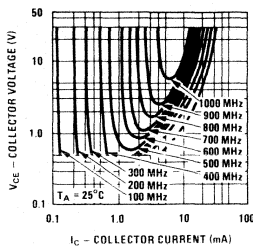

Base Emitter On Voltage vs Collector Current

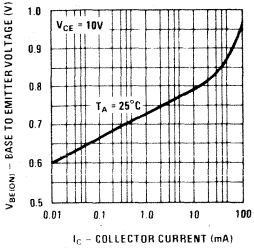

Maximum Power Dissipation vs Ambient Temperature

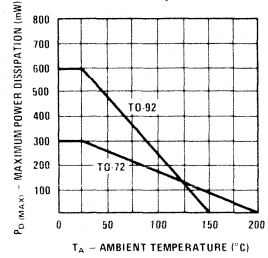

Reverse Transfer Capacitance vs Reverse Bias Voltage

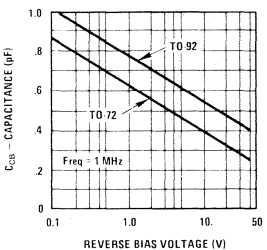

Input Capacitance vs Reverse Bias Voltage

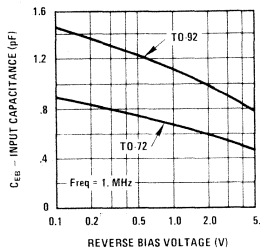

Base-Emitter Saturation Voltage vs Collector Current

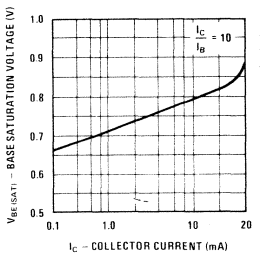

Collector-Emitter Saturation Voltage vs Collector Current

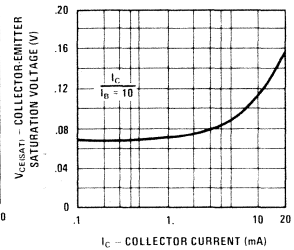

## COMMON BASE Y PARAMETERS VS FREQUENCY

Input Admittance vs Frequency

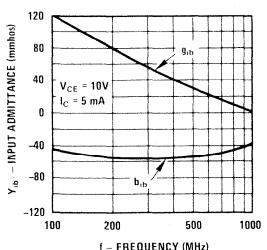

Reverse Transfer Admittance vs Frequency

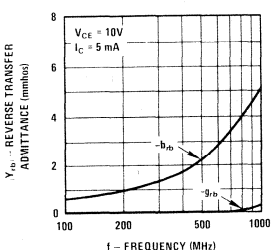

Forward Transfer Admittance vs Frequency

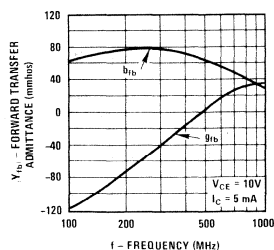

Output Admittance vs Frequency

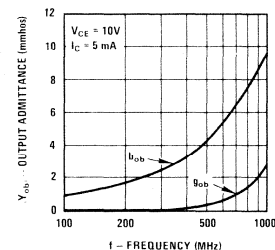

COMMON EMITTER Y PARAMETERS VS FREQUENCY

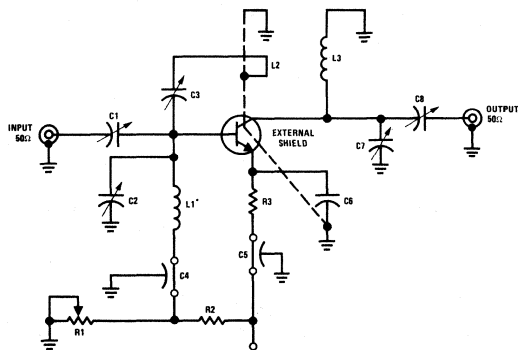
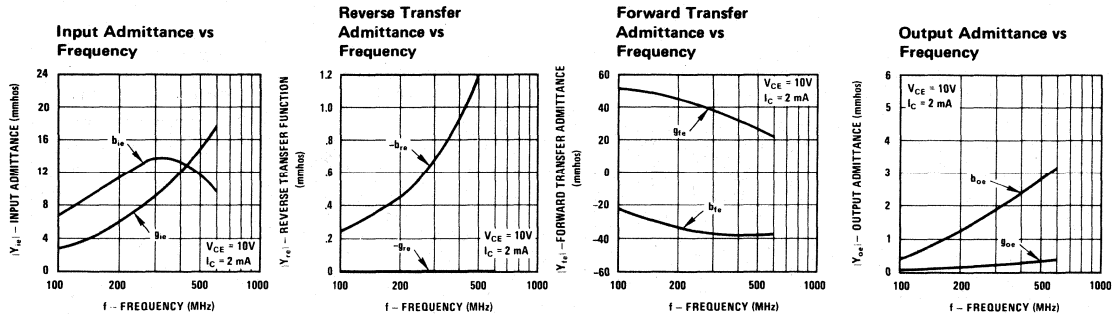

- C1, C2, C3, C7, C8 - 0.010  $\mu$ F VARIABLE CAPACITOR
- C3 - PLASTIC TUBULAR TRIMMER CAPACITOR (ADJUSTED AND FIXED FOR A TRANSISTOR HAVING A TYPICAL VALUE OF  $C_{\mu}$  (0.35 pF))
- C4 - 200 pF BUTTON-TYPE FEEDTHROUGH CAPACITOR
- C5 - 1000 pF FEEDTHROUGH CAPACITOR
- C6 - 470 pF LEADLESS CERAMIC DISC CAPACITOR
- C7 - 1/2 LOOP NO. 14 AWG ENAMELED WIRE PARALLEL TO AND APPROXIMATELY 1/4" FROM L3
- C8 - 1/2 LOOP NO. 14 AWG ENAMELED WIRE PARALLEL TO AND APPROXIMATELY 1/4" FROM L3
- R1 - 5 k $\Omega$ ; POTENTIOMETER
- R2 - 1.2 k $\Omega$
- R3 - 2 k $\Omega$

FIGURE 1. Neutralized 450-MHz Gain and Noise Figure Circuit

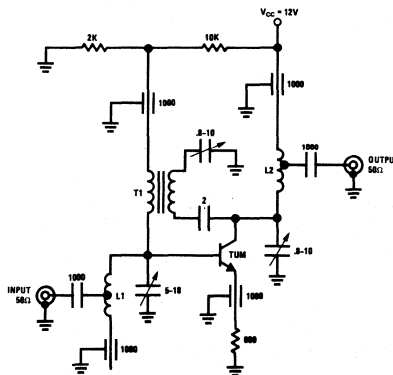

- L1 - 3T #18 WIRE, 1/2" L x 1/4" ID TAPPED 1/2T FROM COLD SIDE
- L2 - 8T #18 WIRE, 1/2" L x 1/4" ID TAPPED 1/2T FROM COLD SIDE
- L3 - 2T #18 WIRE, 1/2" L x 1/4" ID TAPPED 1/2T FROM COLD SIDE
- T1 - PRL T1 #18 WIRE
- T2 - PRL T2 #18 WIRE
- CORE IS INDIANA GENERAL P/N F-684-03

ALL CAPACITANCE IN pF, ALL RESISTANCE IN OHMS.

FIGURE 2. Neutralized 200-MHz PF & NF Circuit

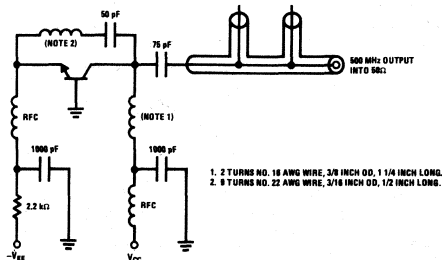

- 1. 2 TURNS NO. 18 AWG WIRE, 3/16 INCH OD, 1 1/4 INCH LONG.
- 2. 8 TURNS NO. 22 AWG WIRE, 3/16 INCH OD, 1/2 INCH LONG.

FIGURE 3. 500 MHz Oscillator Circuit

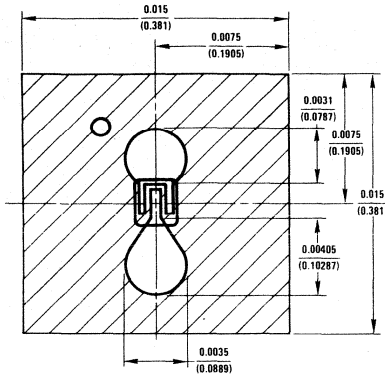
**DESCRIPTION**

Process 43 is an overlay double diffused, silicon epitaxial device.

**APPLICATION**

This device was designed for use as RF amplifiers, oscillators and multipliers with collector current in the 1 mA to 2 mA range.

**PRINCIPAL DEVICE TYPES**

TO-72	2N918
TO-92	PN3563, PN5130 (EBC), 2N3663 (ECB)

PARAMETER	TEST CONDITIONS	MIN	TYP	MAX	UNITS	NOTES
$G_{PE}$	$f = 200 \text{ MHz}, I_C = 5 \text{ mA}, V_{CE} = 10 \text{ V}$	15	18		dB	Neutralized
NF	$f = 60 \text{ MHz}, I_C = 1 \text{ mA}, V_{CE} = 10 \text{ V}$ $R_S = 200\Omega$		3.5	5.0	dB	
PO	$f = 500 \text{ MHz}, I_C = 8 \text{ mA}, V_{CE} = 15 \text{ V}$	20	35		mW	Fig. 1
PO	$f = 900 \text{ MHz}, I_C = 8 \text{ mA}, V_{CE} = 15 \text{ V}$	3.0	8.0		mW	
$h_{fe}$	$I_C = 5 \text{ mA}, V_{CE} = 10 \text{ V}, f = 100 \text{ MHz}$	6.0	9.0			
$rb'Cc$	$f = 79.8 \text{ MHz}, V_{CE} = 10 \text{ V}, I_E = 8 \text{ mA}$		10	25	ps	
$C_{obo}$	$V_{CB} = 10 \text{ V}, I_E = 0$		1.2	1.7	pF	
$C_{eb}$	$V_{EB} = 0.5 \text{ V}, I_C = 0$		1.4	2.0	pF	TO-72
$h_{FE}$	$I_C = 1 \text{ mA}, V_{CE} = 1 \text{ V}$	25	5			
$h_{FE}$	$I_C = 5 \text{ mA}, V_{CE} = 10 \text{ V}$	40	80	200		
$V_{CE(SAT)}$	$I_C = 10 \text{ mA}, I_B = 1 \text{ mA}$		0.25	0.40	V	
$V_{BE(SAT)}$	$I_C = 10 \text{ mA}, I_B = 1 \text{ mA}$			0.95	V	
$BV_{CEO}$	$I_C = 3 \text{ mA}$	15	20	24	V	
$BV_{CBO}$	$I_C = 100 \mu\text{A}$	30			V	
$BV_{EBO}$	$I_E = 10 \mu\text{A}$	4.0			V	
$I_{CB0}$	$V_{CB} = 15 \text{ V}$			50	nA	
$I_{EB0}$	$V_{CB} = 3 \text{ V}$			50	nA	

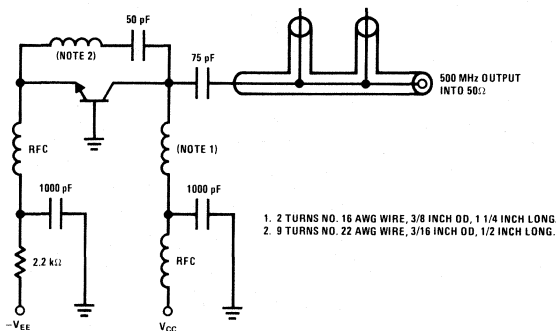
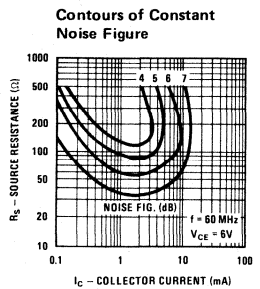
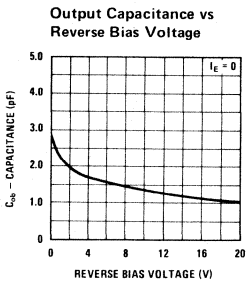
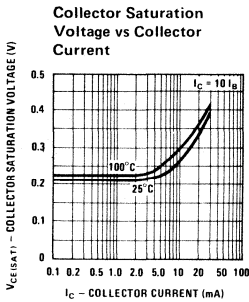
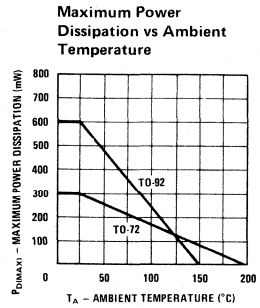
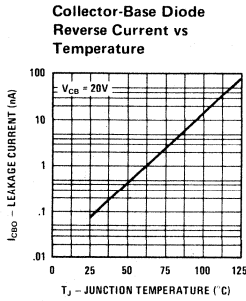
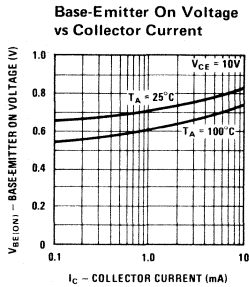
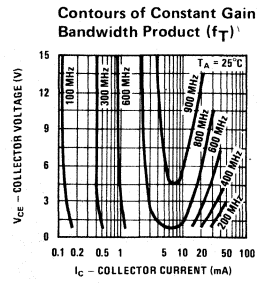
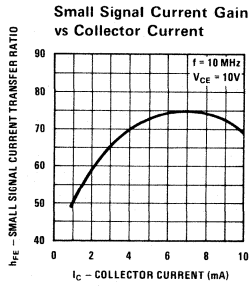
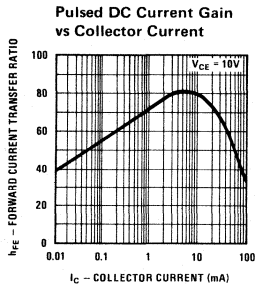

FIGURE 1. 500 MHz Oscillator Circuit



COMMON EMITTER Y PARAMETERS VS FREQUENCY

Process 43

Input Admittance vs Collector Current-Output Short Circuit

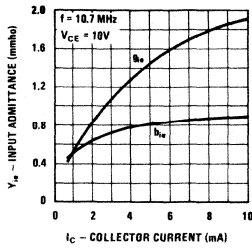

Input Admittance vs Collector Current-Output Short Circuit

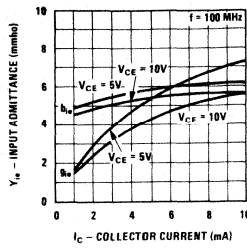

Input Admittance vs Frequency-Output Short Circuit

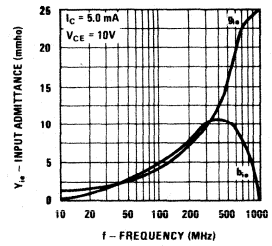

Forward Transfer Admittance vs Collector Current-Output Short Circuit

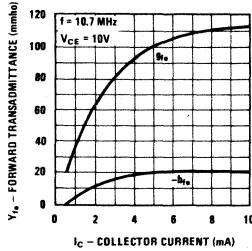

Forward Transfer Admittance vs Collector Current-Output Short Circuit

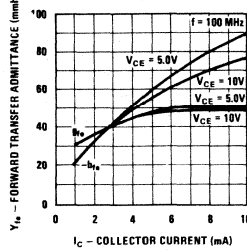

Forward Transfer Admittance vs Frequency-Output Open Circuit

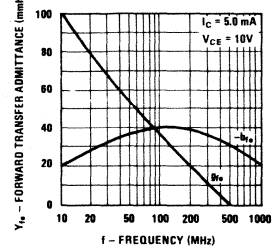

Reverse Transfer Admittance vs Collector Current-Input Short Circuit

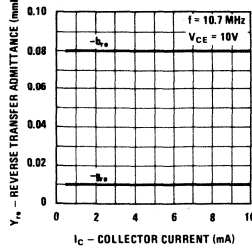

Reverse Transfer Admittance vs Collector Current-Input Short Circuit

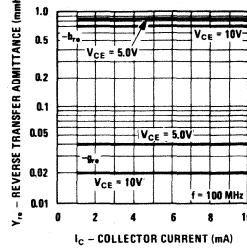

Reverse Transfer Admittance vs Frequency-Input Short Circuit

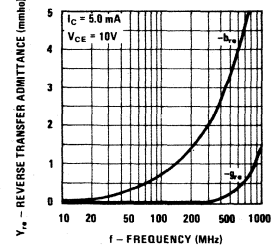

Output Admittance vs Collector Current-Input Short Circuit

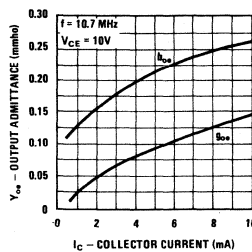

Output Admittance vs Collector Current-Input Short Circuit

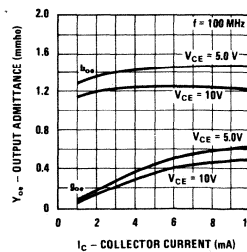

Output Admittance vs Frequency-Input Short Circuit

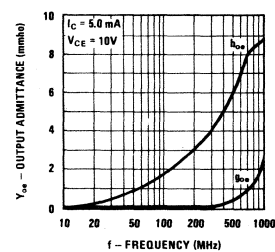

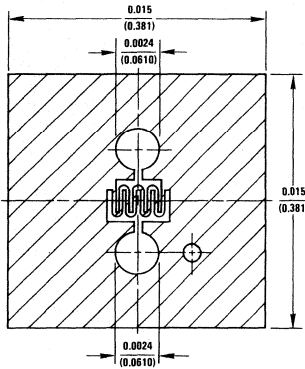

## DESCRIPTION

Process 44 is an overlay double diffused, silicon device.

## APPLICATION

This device was designed for use as a low noise VHF amplifier with forward AGC capability.

## PRINCIPAL DEVICE TYPES

TO-72      SE5020  
TO-92      MPS6568, MPS-H30 (BEC)

PARAMETER	TEST CONDITIONS	MIN	TYP	MAX	UNITS	NOTES
NF	$f = 200 \text{ MHz}, I_C = 2 \text{ mA}, V_{CE} = 10 \text{ V}, R_S = 50 \Omega$		2.0	3.3	dB	Fig. 1
$P_G$	$f = 200 \text{ MHz}, I_C = 2 \text{ mA}, V_{CE} = 10 \text{ V}, R_S = 50 \Omega$	20	24		dB	Fig. 1
NF	$f = 45 \text{ MHz}, I_C = 4 \text{ mA}, V_{CE} = 10 \text{ V}, R_S = 50 \Omega$		3.0	5.0	dB	Fig. 2
$P_G$	$f = 45 \text{ MHz}, I_C = 4 \text{ mA}, V_{CE} = 10 \text{ V}, R_S = 50 \Omega$	23	26		dB	Fig. 2
AGC	$f = 200 \text{ MHz}, V_{AGC}$ at 30 dB Down	4.0	4.5	5.0	V	Fig. 1
AGC	$f = 45 \text{ MHz}, V_{AGC}$ at 30 dB Down	4.3	5.0	5.6	V	Fig. 2
$C_{cb}$	$V_{CB} = 10 \text{ V}, I_E = 0$		0.35	0.50	pF	TO-72
			0.45	0.55	pF	TO-92
$h_{fe}$	$V_{CE} = 10 \text{ V}, I_C = 4 \text{ mA}, f = 100 \text{ MHz}$	3.75	5.5	8.0		
$h_{FE}$	$I_C = 4 \text{ mA}, V_{CE} = 5 \text{ V}$	30	70	200		
$V_{CE(SAT)}$	$I_C = 10 \text{ mA}, I_B = 5 \text{ mA}$		1.0	2.0	V	
$V_{BE(SAT)}$	$I_C = 10 \text{ mA}, I_B = 5 \text{ mA}$		0.85	0.95	V	
$BV_{CEO}$	$I_C = 1 \text{ mA}$	30			V	
$BV_{CBO}$	$I_C = 100 \mu\text{A}$	30			V	
$BV_{EBO}$	$I_E = 10 \mu\text{A}$	4.0			V	
$I_{CBO}$	$V_{CB} = 20 \text{ V}$			100	nA	
$I_{EBO}$	$V_{EB} = 3 \text{ V}$			50	nA	

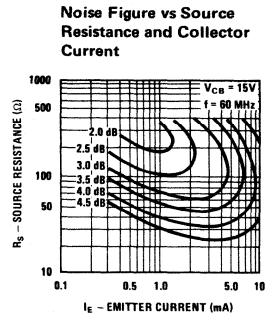
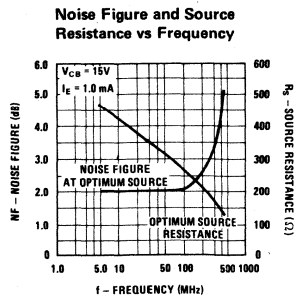
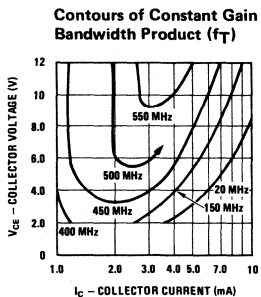
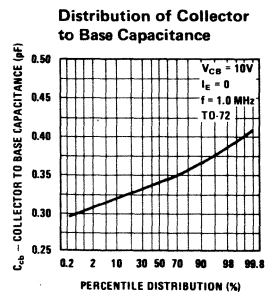
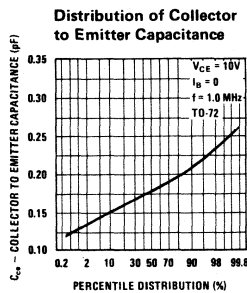
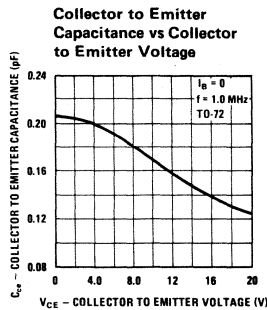
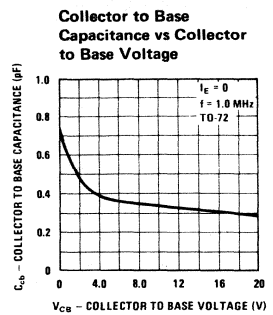
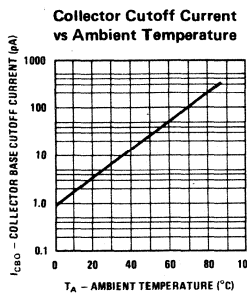
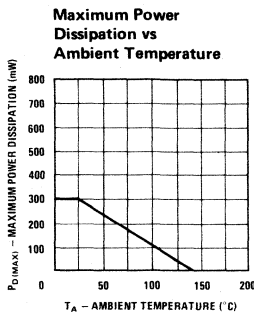
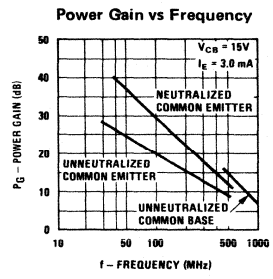
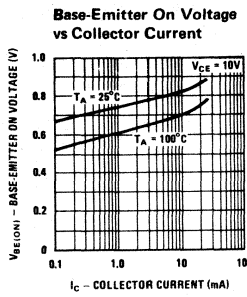
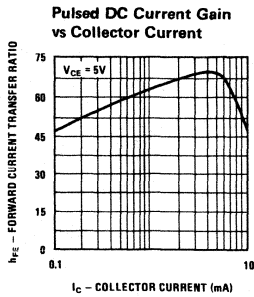

COMMON EMITTER PERFORMANCE

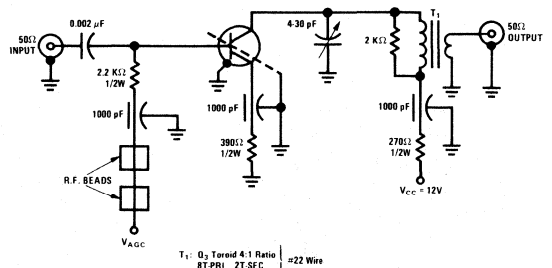
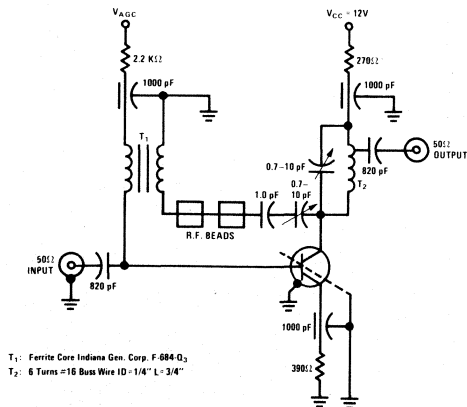
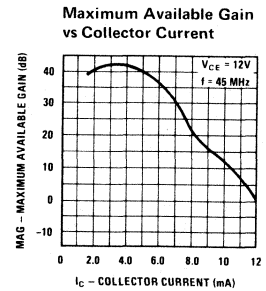
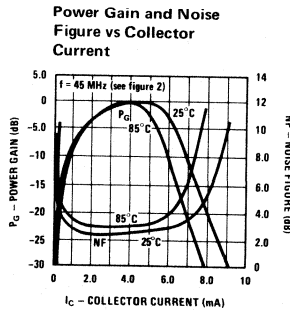
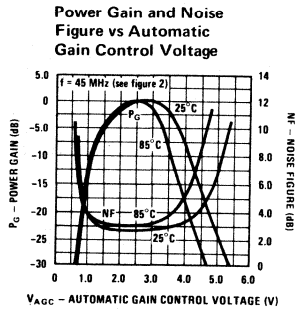
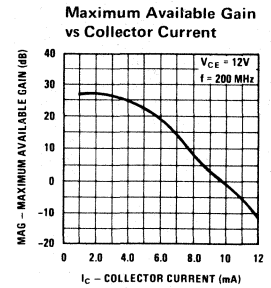
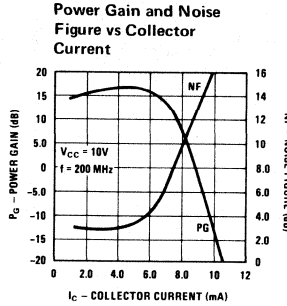
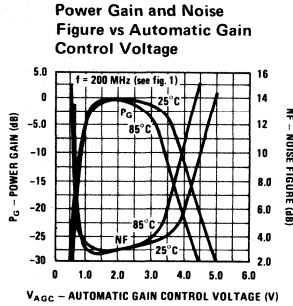

FIGURE 1. 200 MHz, AGC, Power Gain and Noise Figure Test Jig

FIGURE 2. 45 MHz, AGC, Power Gain and Noise Figure Test Jig

COMMON EMITTER Y PARAMETERS VS FREQUENCY

Process 44

Input Admittance vs Collector Current - Output Short Circuit

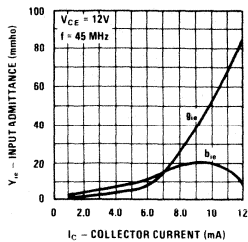

Reverse Transfer Admittance vs Collector Current - Input Short Circuit

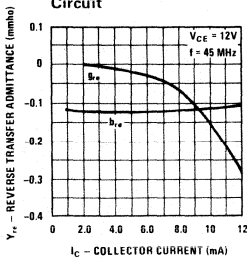

Forward Transfer Admittance vs Collector Current - Output Short Circuit

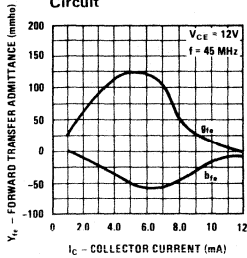

Output Admittance vs Collector Current - Input Short Circuit

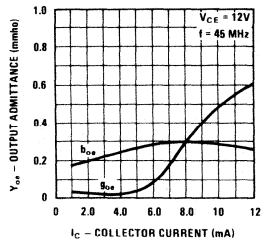

Input Admittance vs Emitter Current - Output Short Circuit

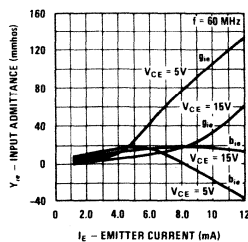

Reverse Transfer Admittance vs Emitter Current - Input Short Circuit

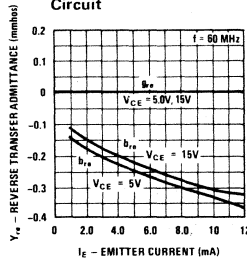

Forward Transfer Admittance vs Emitter Current - Output Short Circuit

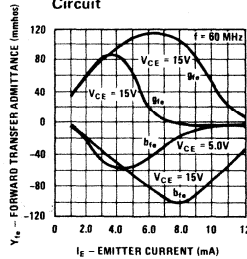

Output Admittance vs Emitter Current - Input Short Circuit

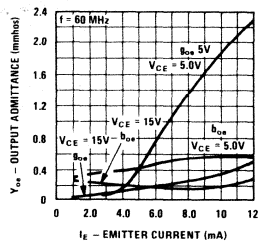

Input Admittance vs Collector Current - Output Short Circuit

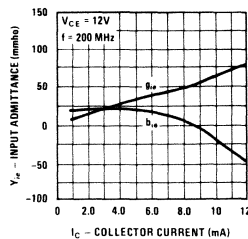

Reverse Transfer Admittance vs Collector Current - Input Short Circuit

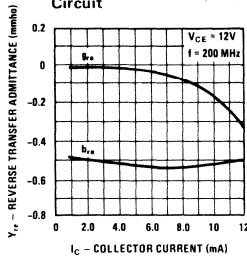

Forward Transfer Admittance vs Collector Current - Output Short Circuit

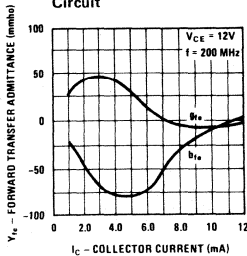

Output Admittance vs Collector Current - Input Short Circuit

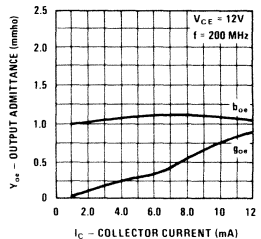

Input Admittance vs Frequency - Output Short Circuit

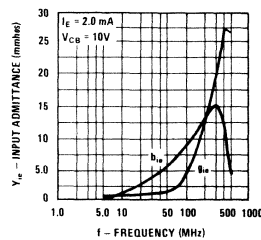

Reverse Transfer Admittance vs Frequency - Output Short Circuit

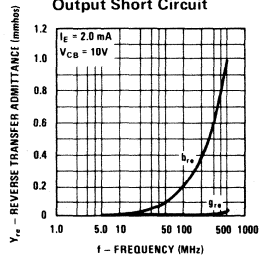

Forward Transfer Admittance vs Frequency - Input Short Circuit

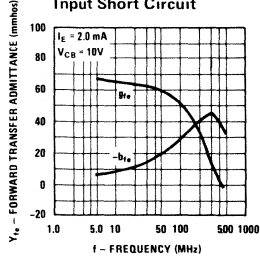

Output Admittance vs Frequency - Input Short Circuit

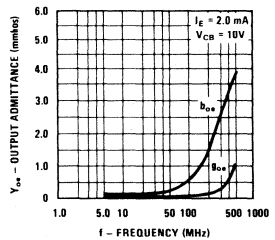

COMMON BASE Y PARAMETERS VS FREQUENCY

Input Admittance vs Collector Current-Output Short Circuit

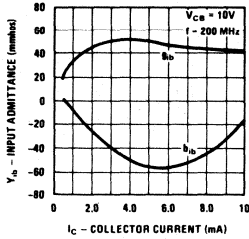

Reverse Transmittance vs Collector Current-Input Short Circuit

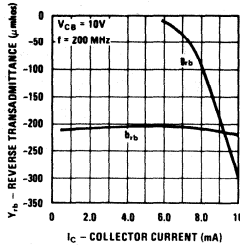

Forward Transmittance vs Collector Current-Output Short Circuit

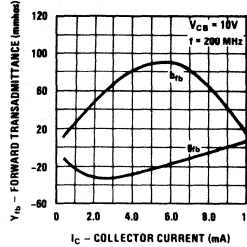

Output Admittance vs Collector Current-Input Short Circuit

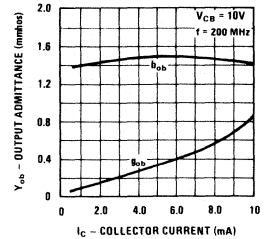

Maximum Stable Gain vs Collector Current Common Base Configuration

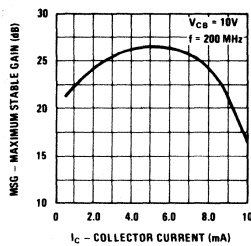

Common Base Configuration Stability Factor-k vs Collector Current

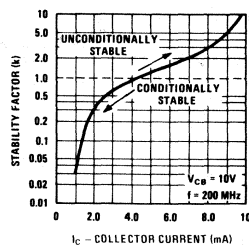

Maximum Stable Gain vs Frequency Common Base Configuration

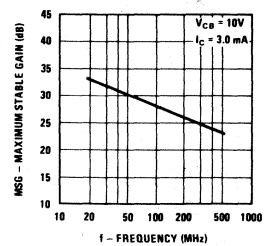

Roll-off stability factor "k" is defined as:  $k = \frac{Z_{out} - R_s (Y_i Y_o)}{Y_i Y_o}$

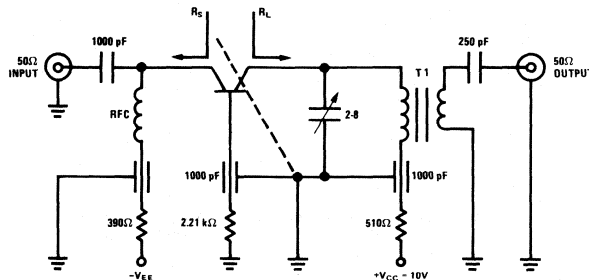

T<sub>1</sub> - 3:1 Ratio No. 22 Bifilar on Micrometals Toroid, P/N T30-12  
 R<sub>S</sub> = 50Ω, R<sub>L</sub> = 2.5 kΩ  
 f<sub>bw</sub> = 8.0 MHz

FIGURE 3. 200 MHz Common Base Power Gain, Noise Figure, Automatic Gain Control Test Circuit.

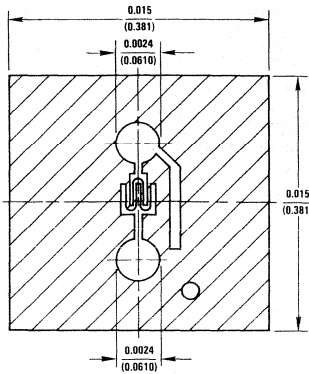
**DESCRIPTION**

Process 45 is an overlay double diffused silicon device, with a Faraday shield diffusion.

**APPLICATION**

This device was designed for use as a forward AGC amplifier in IF amplifiers without neutralization.

**PRINCIPAL DEVICE TYPES**

TO-72                    SE5055 (pkg 28)  
TO-92                    MPS-H32 (BEC)

PARAMETER	TEST CONDITIONS	MIN	TYP	MAX	UNITS	NOTES
$P_G$	$f = 45 \text{ MHz}$ , $V_{CE} = 10\text{V}$ , $I_C = 3 \text{ mA}$ , $R_G = 50\Omega$	27.0	29.5		dB	Fig. 1
NF	$f = 45 \text{ MHz}$ , $V_{CE} = 10\text{V}$ , $I_C = 3 \text{ mA}$ , $R_G = 50\Omega$		2.8	5.0	dB	Fig. 1
$C_{re}$	$V_{CB} = 10\text{V}$ , $I_E = 0$		0.13	0.22	pF	TO-72
$C_{re}$	$V_{CB} = 10\text{V}$ , $I_E = 0$		0.20	0.30	pF	TO-92
$V_{AGC}$	$f = 45 \text{ MHz}$ , $V_{CC} = 12\text{V}$ 30 dB Gain Reduction	3.8	4.4	5.0	V	Fig. 1
$V_{AGC}$	$f = 45 \text{ MHz}$ , $V_{CC} = 12\text{V}$ 50 dB Gain Reduction		6.8	8.0	V	Fig. 1
$h_{fe}$	$V_{CE} = 10\text{V}$ , $I_C = 2 \text{ mA}$ , $f = 100 \text{ MHz}$	3.0	5.5			
$h_{FE}$	$V_{CE} = 10\text{V}$ , $I_C = 2 \text{ mA}$	30	80	200		
$h_{FE}$	$V_{CE} = 10\text{V}$ , $I_C = 10 \text{ mA}$	18	35			
$V_{CE(SAT)}$	$I_C = 10 \text{ mA}$ , $I_B = 5 \text{ mA}$		1.0	2.0	V	
$V_{BE(SAT)}$	$I_C = 10 \text{ mA}$ , $I_B = 5 \text{ mA}$		0.92	1.0	V	
$BV_{CEO}$	$I_C = 1 \text{ mA}$	30			V	
$BV_{CBO}$	$I_C = 100 \mu\text{A}$	30			V	
$BV_{EBO}$	$I_E = 10 \mu\text{A}$	4.0			V	
$I_{CBO}$	$V_{CB} = 20\text{V}$			100	nA	
$I_{EBO}$	$V_{EB} = 3\text{V}$			50	nA	

DC Current Gain vs Collector Current

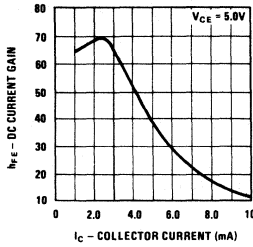

DC Pulse Current Gain vs Collector Current

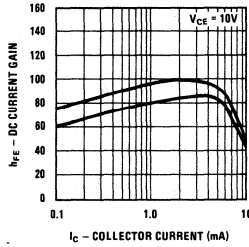

Base-Emitter On Voltage vs Collector Current

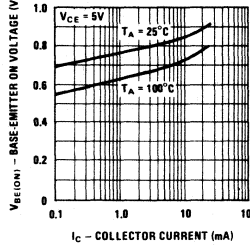

Maximum Power Dissipation vs Ambient Temperature

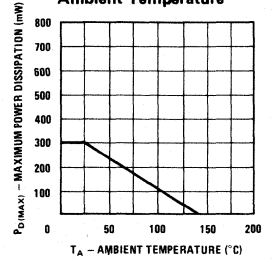

Noise Figure vs Frequency

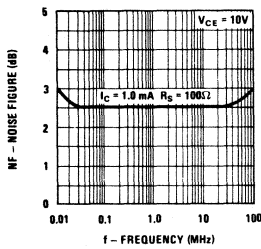

Collector Cutoff Current vs Ambient Temperature

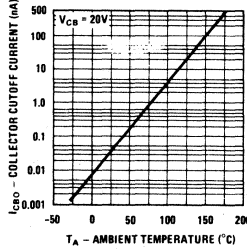

Collector Saturation Voltage vs Collector Current

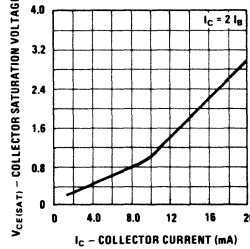

Base Saturation Voltage vs Collector Current

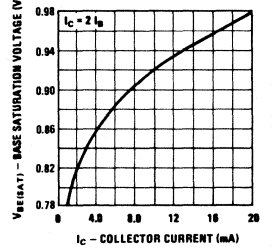

Distribution of Collector to Base Capacitance

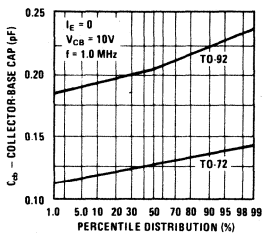

Collector-Base Capacitance vs Collector-Base Voltage

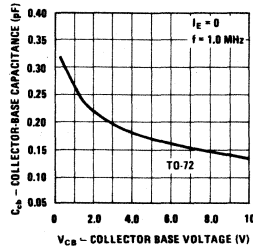

Contours of Constant Gain Bandwidth Product (fT)

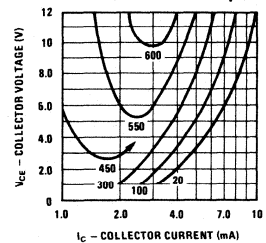



COMMON EMITTER Y PARAMETERS VS FREQUENCY

Input Admittance vs Collector Current - Output Short Circuit

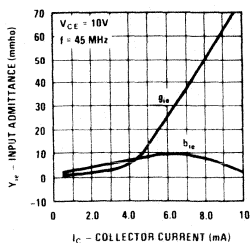

Reverse Transfer Admittance vs Collector Current - Input Short Circuit

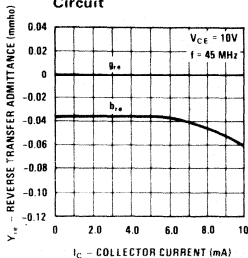

Forward Transfer Admittance vs Collector Current - Output Short Circuit

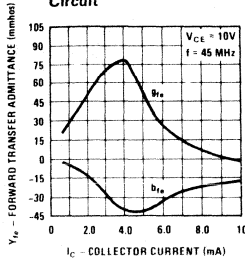

Output Admittance vs Collector Current - Input Short Circuit

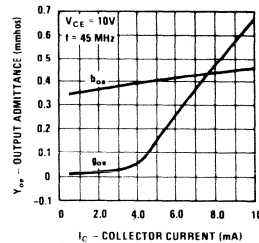

Input Admittance vs Collector Voltage - Output Short Circuit

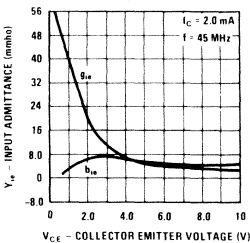

Reverse Transfer Admittance vs Collector Voltage - Input Short Circuit

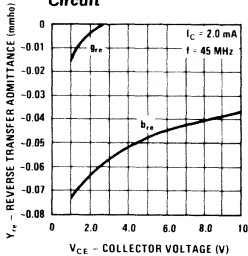

Forward Transfer Admittance vs Collector Voltage - Output Short Circuit

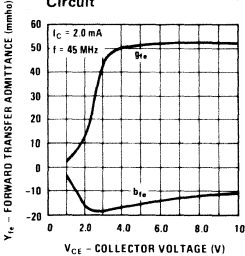

Output Admittance vs Collector Voltage - Input Short Circuit

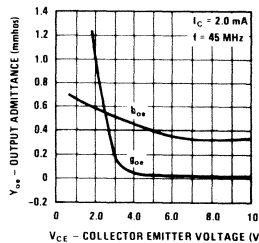

Input Admittance vs Frequency - Output Short Circuit

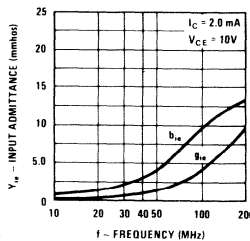

Reverse Transadmittance vs Frequency - Input Short Circuit

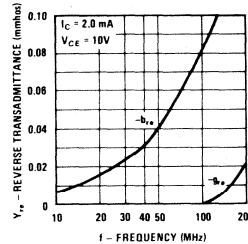

Forward Transadmittance vs Frequency - Output Short Circuit

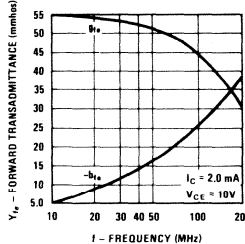

Output Admittance vs Frequency - Input Short Circuit

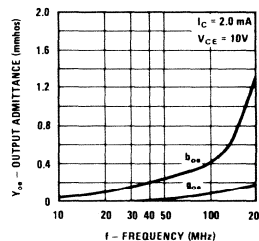

COMMON EMITTER PERFORMANCE

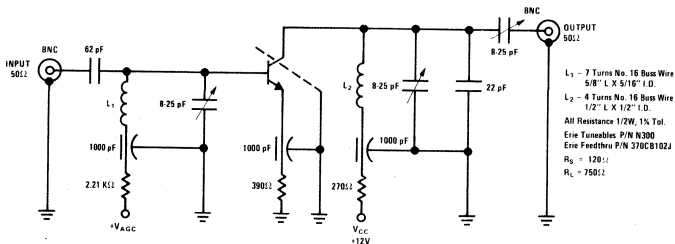
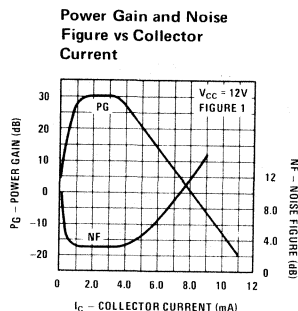
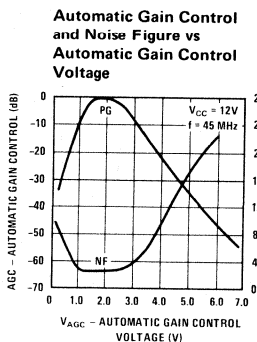
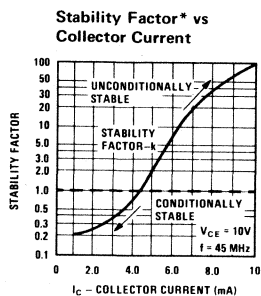
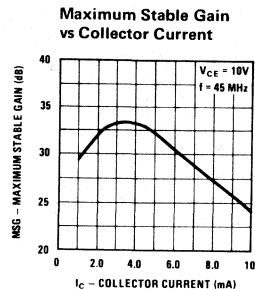
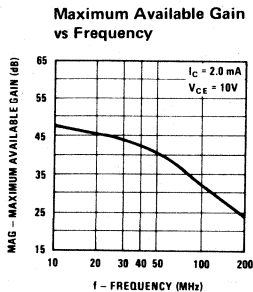
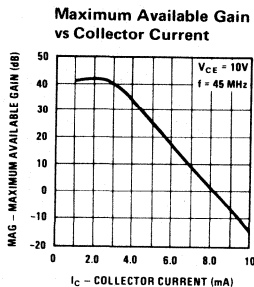
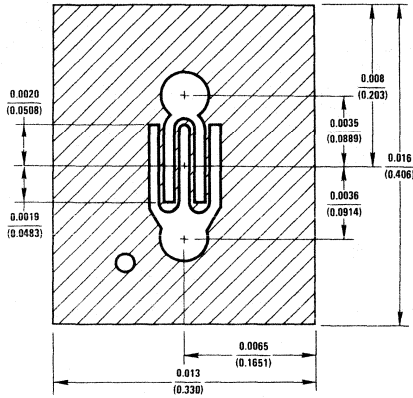

FIGURE 1. SE5055 45 MHz Gain, Noise Figure, AGC Circuit

\* Rollett stability factor "k" is defined as:  $k = \frac{2 - R_{11} - R_{22}}{|Y_1 Y_2|}$

**DESCRIPTION**

Process 46 is an overlay double diffused, silicon epitaxial device.

**APPLICATION**

This device was designed for linear RF amplifier applications up to 100 MHz with collector current in the 1 mA to 30 mA range.

**PRINCIPAL DEVICE TYPES**

TO-92      ST5025

PARAMETER	TEST CONDITIONS	MIN	TYP	MAX	UNITS	NOTES
$G_{pe}$	$f = 45 \text{ MHz}, V_{CE} = 10V, I_C = 10 \text{ mA}$	25	28		dB	
$C_{cb}$	$V_{CB} = 10V$		0.8	1.0	pF	TO-92
$g_{oe}$	$f = 45 \text{ MHz}, V_{CE} = 10V, I_C = 10 \text{ mA}$			200	$\mu\text{mho}$	
$h_{fe}$	$I_C = 10 \text{ mA}, V_{CE} = 10V, f = 100 \text{ MHz}$	3.0	4.50			
$h_{FE}$	$I_C = 10 \text{ mA}, V_{CE} = 10V$	30	100	250		
$V_{CE(SAT)}$	$I_C = 20 \text{ mA}, I_B = 1 \text{ mA}$		0.2	0.6	V	
$BV_{CEO}$	$I_C = 1 \text{ mA}$	30	55		V	
$BV_{CBO}$	$I_C = 100 \mu\text{A}$	35			V	
$BV_{EBO}$	$I_C = 10 \mu\text{A}$	4.0			V	
$I_{CBO}$	$V_{CB} = 30V$			50	nA	
$I_{EBO}$	$V_{EB} = 3V$			50	nA	

DC Pulse Current Gain vs Collector Current

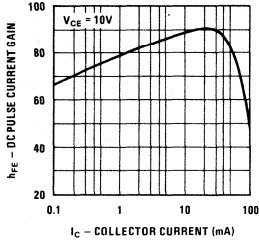

Base-Emitter On Voltage vs Collector Current

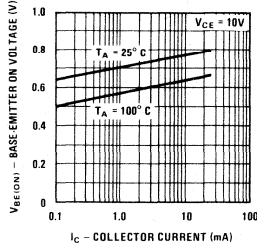

Maximum Power Dissipation vs Ambient Temperature

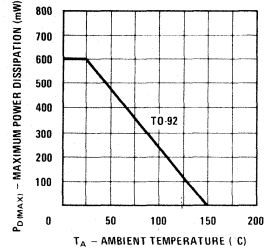

Maximum Power Dissipation vs Case Temperature

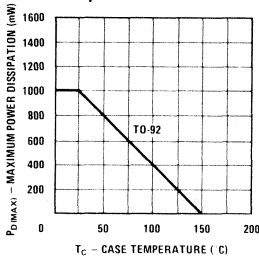

Reverse Transfer Capacitance vs Reverse Bias Voltage

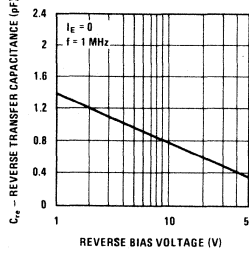

Contours of Constant Gain Bandwidth Product (fT)

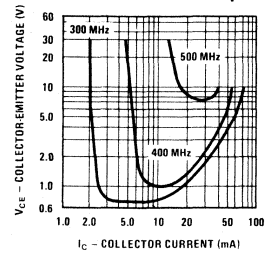

Collector-Emitter Saturation Voltage vs Collector Current

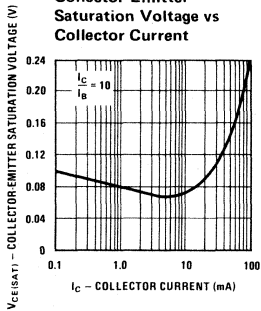

Base-Emitter Saturation Voltage vs Collector Current

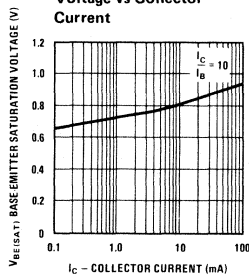

Capacitance vs Reverse Bias Voltage

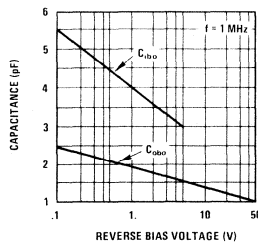

Collector-Base Diode Reverse Current vs Temperature

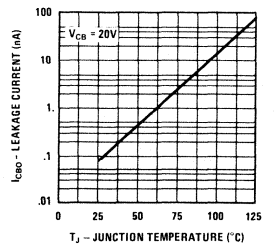

# Process 46

**Input Admittance vs Collector Current**

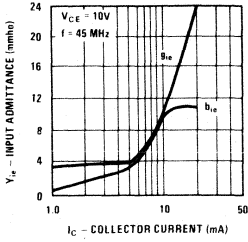

**Output Admittance vs Collector Current**

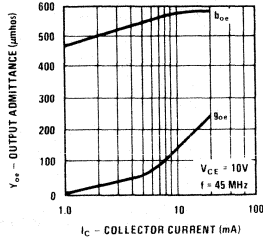

**Forward Transfer Admittance vs Collector Current**

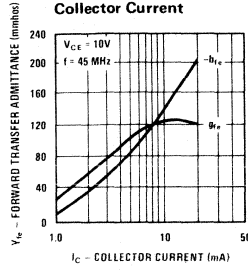

**Reverse Transfer Admittance vs Collector Current**

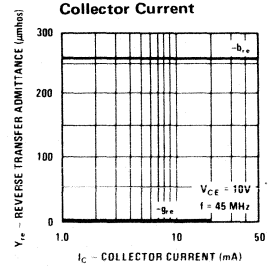

**Input Admittance vs Frequency**

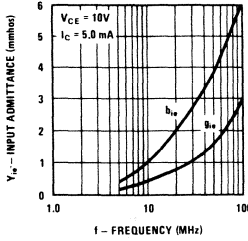

**Output Admittance vs Frequency**

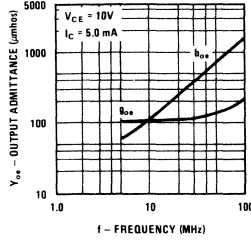

**Forward Transfer Admittance vs Frequency**

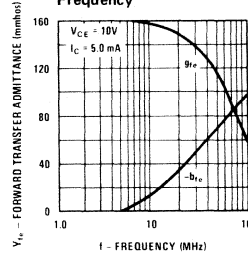

**Reverse Transfer Admittance vs Frequency**

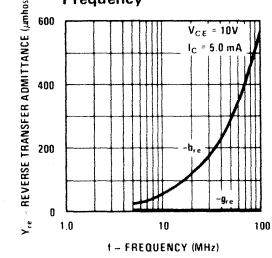

**Small Signal Input Resistance vs Collector Current**

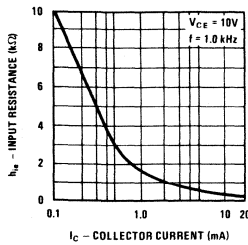

**Small Signal Output Conductance vs Collector Current**

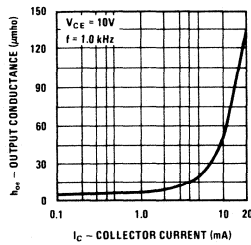

**Small Signal Current Gain vs Collector Current**

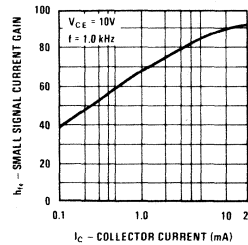

**Small Signal Voltage Feedback Ratio vs Collector Current**

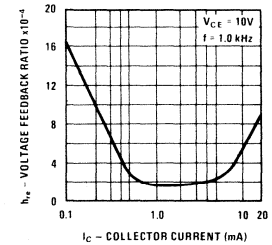

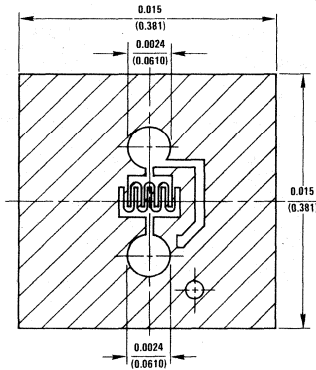

### DESCRIPTION

Process 47 is an overlay double diffused, silicon epitaxial device, with a Faraday shield diffusion.

### APPLICATION

This device was designed for common-emitter low noise amplifier and mixer applications in the 100  $\mu$ A to 15 mA range to 300 MHz, and low frequency drift common-base VHF oscillator applications with high output levels for driving FET mixers.

### PRINCIPAL DEVICE TYPES

TO-72            SE5035  
TO-92            ST5030B, MPSH24, MPSH11

PARAMETER	TEST CONDITIONS	MIN	TYP	MAX	UNITS	NOTES
$P_G$	$f = 45 \text{ MHz}, V_{CE} = 10\text{V}, I_C = 4 \text{ mA}$	29	33		dB	Fig. 1
$P_G$	$f = 200 \text{ MHz}, V_{CE} = 10\text{V}, I_C = 2 \text{ mA}$	17	19.5		dB	Unneutralized Fig. 3
NF	$f = 200 \text{ MHz}, V_{CE} = 10\text{V}, I_C = 2 \text{ mA}, R_S = 50\Omega$		2.0	4.0	dB	Fig. 3
$rb'Cc$	$f = 79.8 \text{ MHz}, V_{CB} = 10\text{V}, I_E = 5 \text{ mA}$		6.5	15.0	ps	
$h_{fe}$	$f = 100 \text{ MHz}, V_{CE} = 15\text{V}, I_C = 7 \text{ mA}$	6	10			
$C_{ib}$	$V_{EB} = 0.5\text{V}, I_C = 0$		2.0	3.0	pF	TO-92
$C_{cb}$	$V_{CB} = 10\text{V}, I_E = 0$	0.25	0.33	0.40	pF	TO-92
$g_{oe}$	$f = 45 \text{ MHz}, V_{CE} = 15\text{V}, I_C = 7 \text{ mA}$			125	$\mu\text{mho}$	
$roep$	$f = 10.7 \text{ MHz}, V_{CE} = 10\text{V}, I_C = 2 \text{ mA}$	100k			$\Omega$	
$h_{FE}$	$V_{CE} = 15\text{V}, I_C = 7 \text{ mA}$	40	100	200		
$V_{CE(SAT)}$	$I_C = 20 \text{ mA}, I_B = 1 \text{ mA}$		0.3	1.0	V	
$V_{BE(SAT)}$	$I_C = 10 \text{ mA}, I_B = 5 \text{ mA}$		0.85	0.92	V	
$BV_{CEO}$	$I_C = 10 \text{ mA}$	20	30		V	
$BV_{CBO}$	$I_C = 100 \mu\text{A}$	35	45		V	
$BV_{EBO}$	$I_E = 10 \mu\text{A}$	4.0			V	
$I_{CBO}$	$V_{CB} = 30\text{V}$			50	nA	
$I_{EBO}$	$V_{EB} = 3\text{V}$			50	nA	

# Process 47

**DC Pulse Current Gain vs Collector Current**

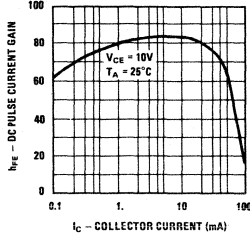

**Base-Emitter On Voltage vs Collector Current**

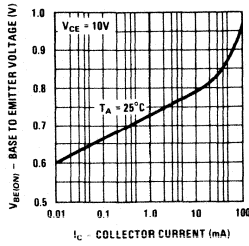

**Maximum Power Dissipation vs Ambient Temperature**

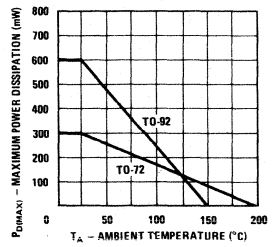

**Maximum Power Dissipation vs Case Temperature**

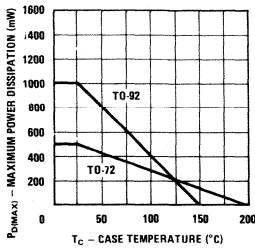

**Capacitance vs Reverse Bias Voltage**

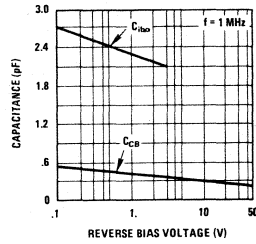

**Collector-Base Diode Reverse Current vs Temperature**

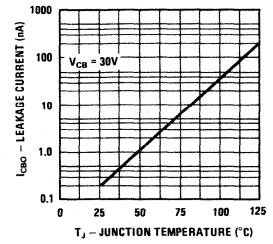

**DC Current Gain vs Collector Current**

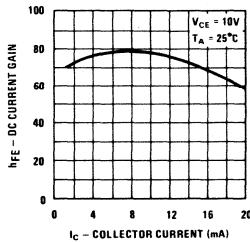

**Contours of Constant Gain Bandwidth Product (fT)**

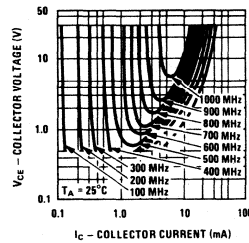

**Max Stable Gain vs Collector Current**

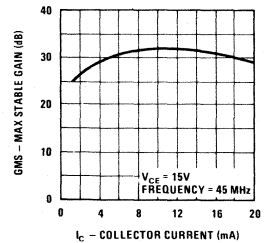

COMMON EMITTER VS FREQUENCY Y PARAMETERS

Input Admittance vs Collector Current

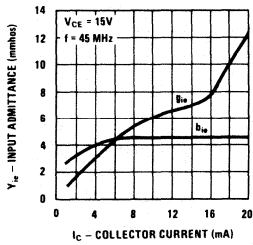

Input Admittance vs Collector Current

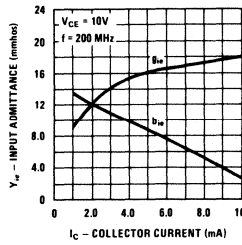

Input Admittance vs Collector Voltage

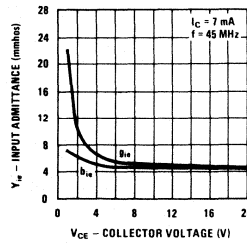

Input Admittance vs Frequency

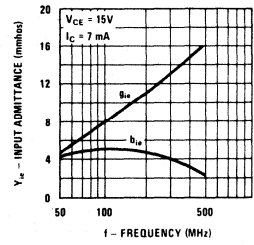

Forward Transfer Admittance vs Collector Current

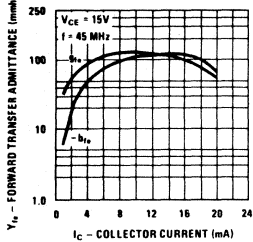

Forward Transfer Admittance vs Collector Current

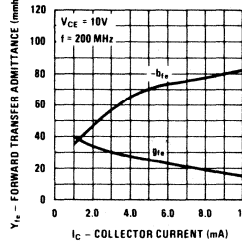

Forward Transfer Admittance vs Collector Voltage

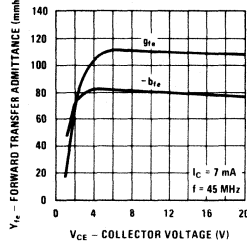

Forward Transfer Admittance vs Frequency

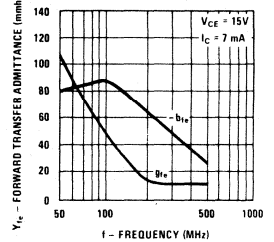

Reverse Transfer Admittance vs Collector Current

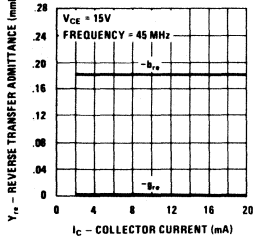

Reverse Transfer Admittance vs Collector Current

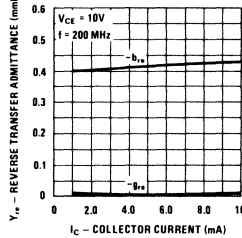

Reverse Transfer Admittance vs Collector Voltage

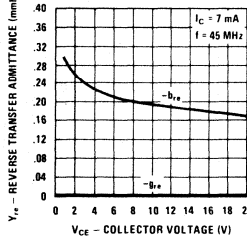

Reverse Transfer Admittance vs Frequency

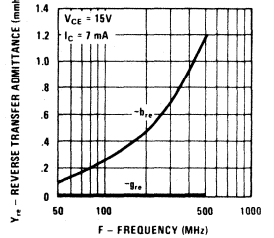

Output Admittance vs Collector Current

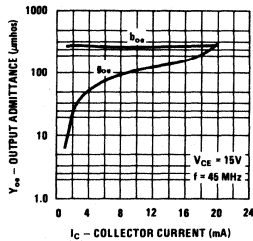

Output Admittance vs Collector Current

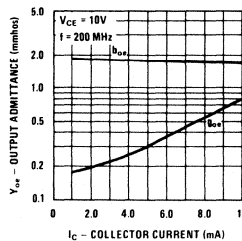

Output Admittance vs Collector Voltage

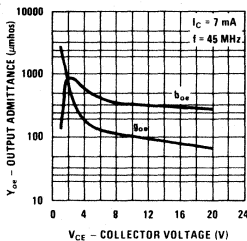

Output Admittance vs Frequency

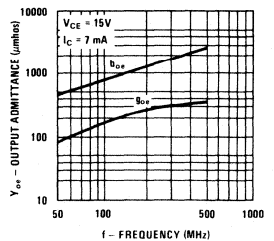



**Power Gain and Noise Figure vs Collector Current**

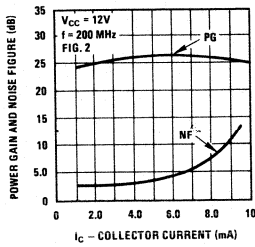

**Conversion Gain vs Collector Current**

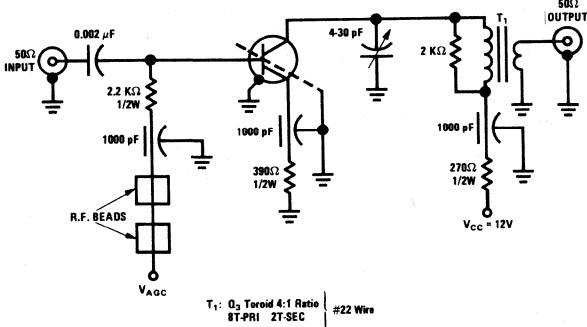
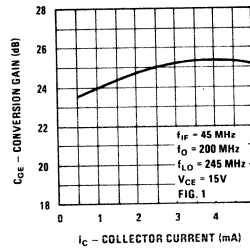

FIGURE 1. 45 MHz Power Gain Circuit

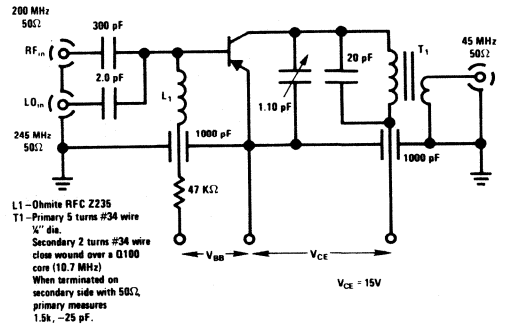

FIGURE 2. 200 MHz Conversion Gain Test Circuit

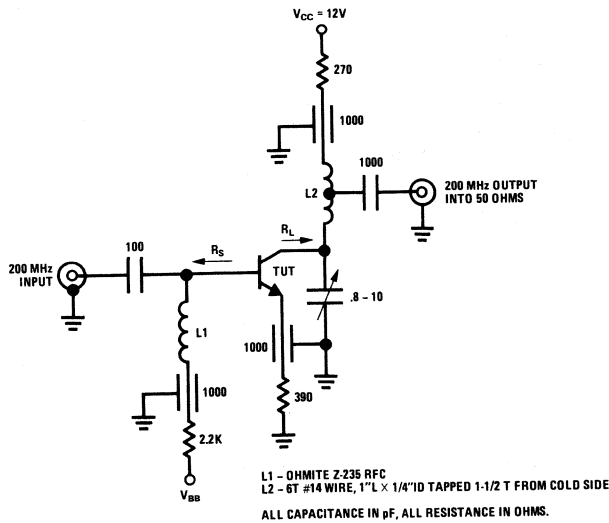
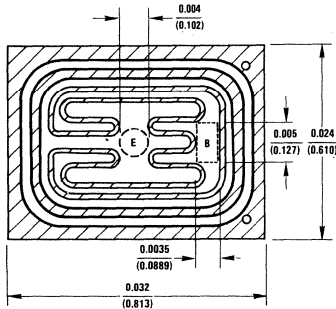

FIGURE 3. Unneutralized 200 MHz PG NF Test Circuit



**DESCRIPTION**

Process 48 is a nonoverlay triple diffused, silicon device with a field plate.

**APPLICATION**

This device was designed for application as a video output to drive color CRT.

**PRINCIPAL DEVICE TYPES**

- TO-39      SE7056
- TO-202    SV7056, NSD134

PARAMETER	TEST CONDITIONS	MIN	TYP	MAX	UNITS	NOTES
$C_{cb}$	$V_{CB} = 20 V$		2.5	3.5	pF	TO-39
$h_{fe}$	$f = 20 \text{ MHz}, V_{CE} = 100 V$ $I_C = 15 \text{ mA}$	2.5	4.0			
$h_{fe}$	$I_C = 1 \text{ mA}, V_{CE} = 10V$	15	50			
$h_{fe}$	$I_C = 10 \text{ mA}, V_{CE} = 10V$	40	80	160		
$h_{fe}$	$I_C = 30 \text{ mA}, V_{CE} = 10V$	30	100			
$V_{CE(SAT)}$	$I_C = 20 \text{ mA}, I_B = 2 \text{ mA}$		0.35	1.0	V	
$V_{BE(SAT)}$	$I_C = 20 \text{ mA}, I_B = 2 \text{ mA}$		0.74	0.85	V	
$C_{eb}$	$V_{EB} = 0.5V$		45	70	pF	
$BV_{CEO}$	$I_C = 5 \text{ mA}$	220	280	320	V	
$BV_{CBO}$	$I_C = 100 \mu A$	320	410	470	V	
$BV_{EBO}$	$I_E = 100 \mu A$	7.0			V	
$I_{CBO}$	$V_{CB} = 150V$			100	nA	
$I_{EBO}$	$V_{EB} = 6V$			100	nA	

# Process 48

**DC Pulse Current Gain vs Collector Current**

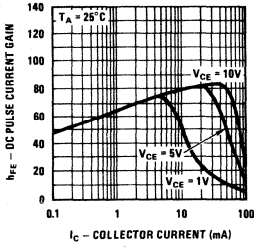

**Base-Emitter On Voltage vs Collector Current**

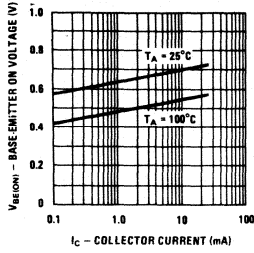

**Maximum Power Dissipation vs Ambient Temperature**

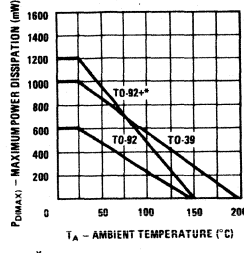

**Maximum Power Dissipation vs Case Temperature**

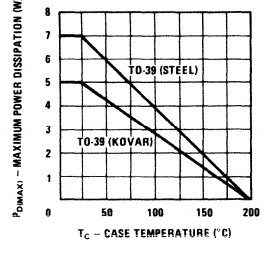

**Guaranteed Maximum DC Power Dissipation vs Collector-Emitter Voltage, TO-39**

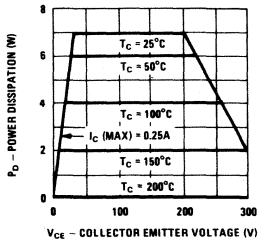

**Collector to Base and Emitter to Base Capacitance vs Reverse Bias Voltage**

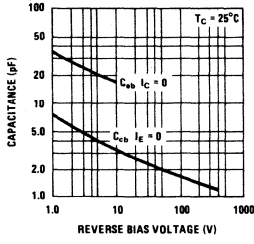

**Contours of Constant Gain Bandwidth Product**

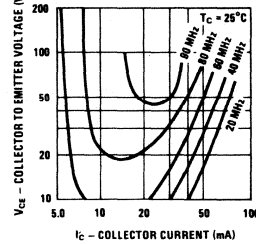

**Collector-Base Diode Reverse Current vs Temperature**

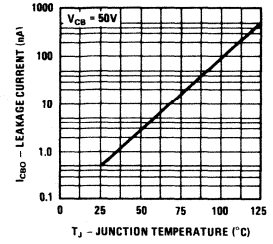

**Collector Cutoff Current vs Collector Voltage**

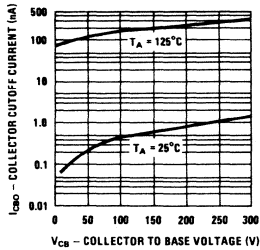

**Base Saturation Voltage vs Collector Current**

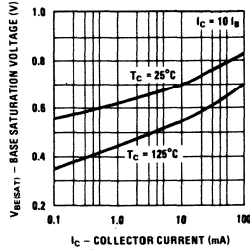

**Collector Saturation Voltage vs Collector Current**

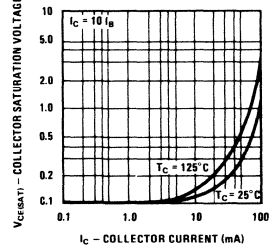

**Safe Operating Area, TO-202**

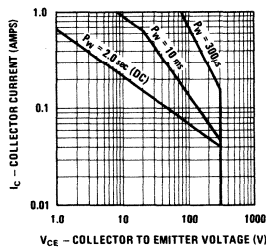

**Maximum Power Dissipation TO-202 vs Case and Ambient Temperature**

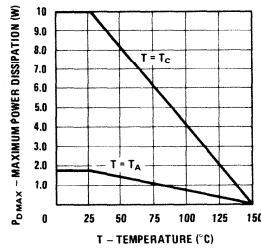

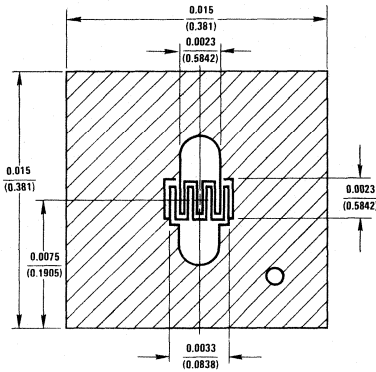

## DESCRIPTION

Process 49 is an overlay double diffused silicon epitaxial device.

## APPLICATION

This device was designed for general RF amplifier and mixer applications to 250 MHz with collector current in the 1 mA to 20 mA range.

## PRINCIPAL DEVICE TYPES

TO-92 (BEC) MPS6544, MP5H20

PARAMETER	TEST CONDITIONS	MIN	TYP	MAX	UNITS	NOTES
$P_G$	$f = 45 \text{ MHz}, V_{CE} = 10\text{V}, I_C = 10 \text{ mA}$	25	30		dB	
$f_t$	$V_{CE} = 10\text{V}, I_C = 10 \text{ mA}$	400	700		MHz	
$rb'C_c$	$f = 31.9 \text{ MHz}, V_{CE} = 10\text{V}, I_C = 8 \text{ mA}$		7.5	20.0	ps	TO-92
$C_{cb}$	$f = 1.0 \text{ MHz}, V_{CB} = 10\text{V}, I_E = 0$		0.55	0.65	pF	TO-92
$h_{FE}$	$V_{CE} = 10\text{V}, I_C = 10 \text{ mA}$	30	100	250		
$h_{FE}$	$V_{CE} = 10\text{V}, I_C = 4 \text{ mA}$	30	90			
$V_{BE(ON)}$	$V_{CE} = 10\text{V}, I_C = 10 \text{ mA}$		0.80	0.95	V	
$V_{CE(SAT)}$	$I_C = 30 \text{ mA}, I_C = 3 \text{ mA}$		0.15	0.50	V	
$g_{oe}$	$f = 45 \text{ MHz}, V_{CE} = 10\text{V}, I_C = 10 \text{ mA}$			100	$\mu\text{mhos}$	
$r_{oep}$	$f = 4.5 \text{ MHz}, V_{CE} = 10\text{V}, I_C = 2 \text{ mA}$	80k			$\Omega$	
$BV_{CEO}$	$I_C = 1 \text{ mA}$	30	40	55	V	
$BV_{CBO}$	$I_C = 100 \mu\text{A}$	45			V	
$BV_{EBO}$	$I_E = 10 \mu\text{A}$	4.0			V	
$I_{CBO}$	$V_{CB} = 30\text{V}$			100	nA	
$I_{EBO}$	$V_{EB} = 3.0\text{V}$			50	nA	

DC Pulse Current Gain vs Collector Current

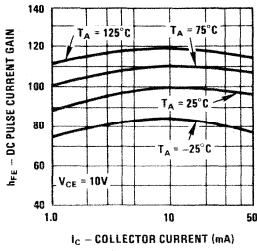

Input Admittance vs Collector Current

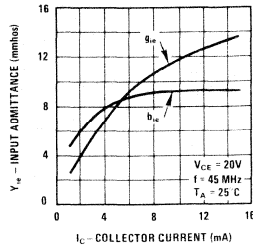

Input Admittance vs Frequency

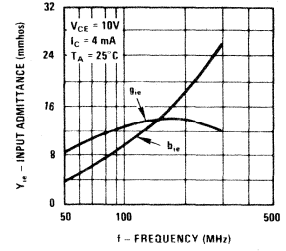

Maximum Power Dissipation vs Case Temperature

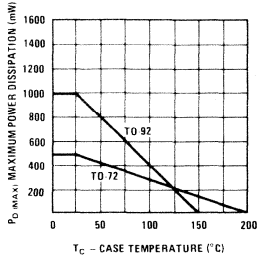

Reverse Transfer Admittance vs Collector Current

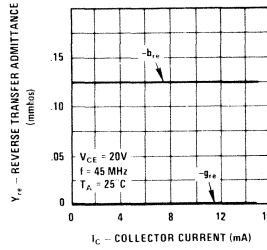

Reverse Transfer Admittance vs Frequency

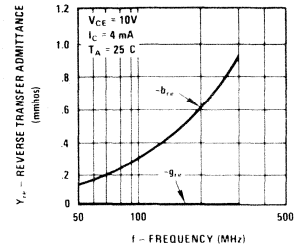

Maximum Power Dissipation vs Ambient Temperature

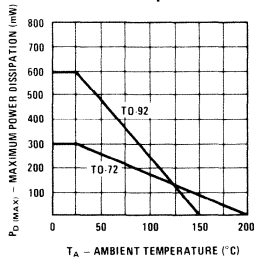

Forward Transfer Admittance vs Collector Current

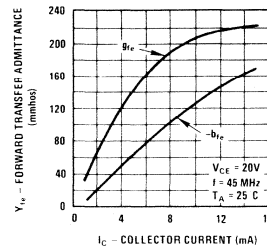

Forward Transfer Admittance vs Frequency

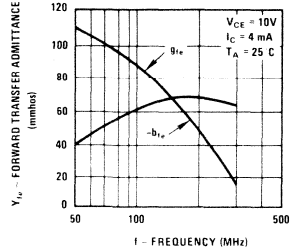

Capacitance vs Reverse Bias Voltage

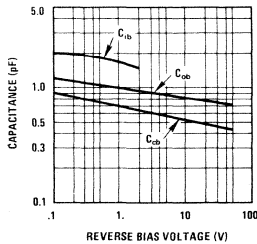

Output Admittance vs Collector Current

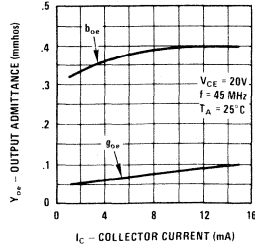

Output Admittance vs Frequency

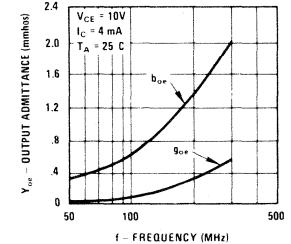

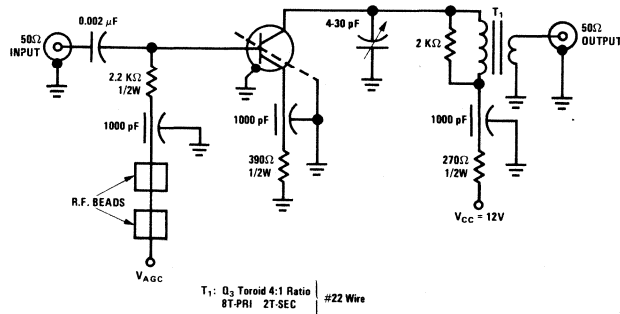
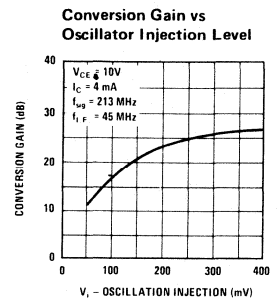
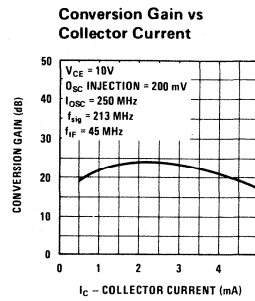
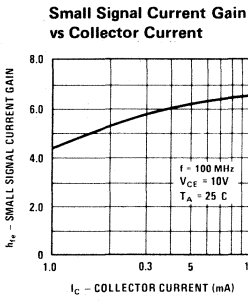

FIGURE 1. 45 MHz Power Gain Circuit

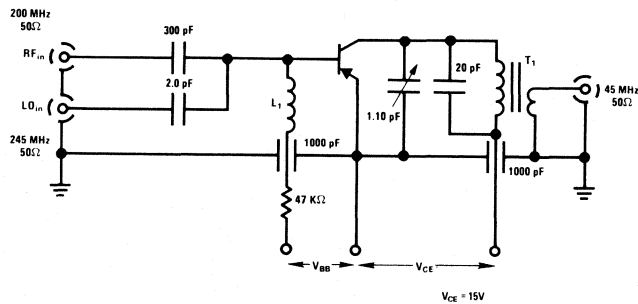
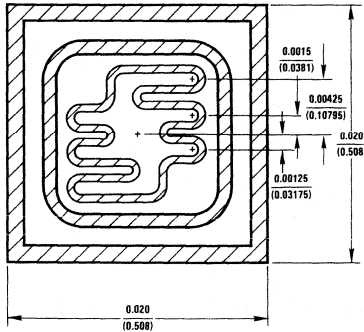

FIGURE 2. 200 MHz Conversion Gain Test Circuit

**DESCRIPTION**

Complements Process 09.

**APPLICATION**

These devices are designed for general purpose amplifier applications at collector currents to 500 mA.

**PRINCIPAL DEVICE TYPES**

TO-92      MPS6563

PARAMETER	TEST CONDITIONS	MIN	TYP	MAX	UNITS	NOTES
$C_{OB}$	$V_{CB} = 10V$		8	12	pF	
$C_{IB}$	$V_{EB} = 1V$		22	26	pF	
NF	$V_{CE} = 10V, I_C = 1 mA$ $R_S = 1k, f = 1 kHz$		0.5		dB	
$f_T$	$V_{CE} = 10V, I_C = 100 mA$		400		MHz	
$h_{FE}$	$V_{CE} = 1V, I_C = 1 mA$	55	160	325		
$h_{FE}$	$V_{CE} = 1V, I_C = 50 mA$	50	150	300		
$h_{FE}$	$V_{CE} = 1V, I_C = 150 mA$	40	125	245		
$h_{FE}$	$V_{CE} = 1V, I_C = 500 mA$	20	65	125		
$V_{CE(SAT)}$	$I_C = 150 mA, I_B = 15 mA$		0.1	0.2	V	
$V_{CE(SAT)}$	$I_C = 500 mA, I_B = 50 mA$		0.3	0.5	V	
$V_{BE(SAT)}$	$I_C = 150 mA, I_B = 15 mA$		0.8	0.96	V	
$V_{BE(SAT)}$	$I_C = 500 mA, I_B = 50 mA$		0.98	1.2	V	
$I_{CES}$	$V_{CE} = 20V$			100	nA	
$I_{CEO}$	$V_{CE} = 20V$			100	nA	
$BV_{CBO}$	$I_C = 100 \mu A$	40			V	
$BV_{EBO}$	$I_E = 10 \mu A$	7	8		V	
$BV_{CEO}$	$I_C = 10 mA$	20	30	40	V	

**DC Pulse Current Gain vs Collector Current**

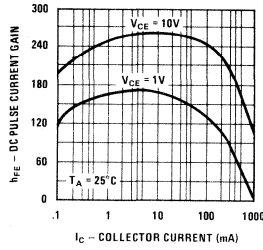

**Collector-Emitter Saturation Voltage vs Collector Current**

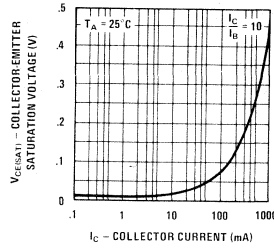

**Base-Emitter Saturation Voltage vs Collector Current**

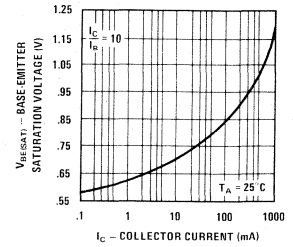

**Base-Emitter On Voltage vs Collector Current**

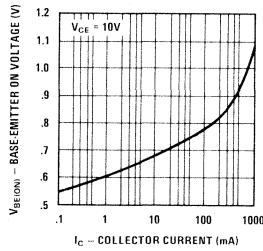

**Collector-Base Capacitance vs Reverse Bias Voltage**

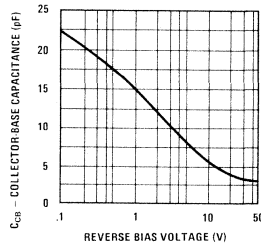

**Input Capacitance vs Reverse Bias Voltage**

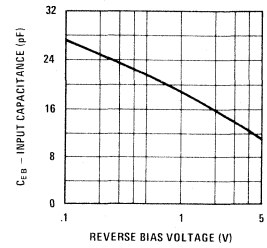

**Collector-Base Diode Reverse Current vs Temperature**

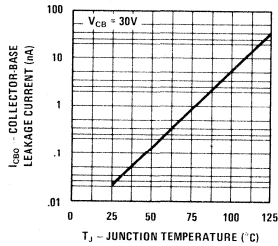

**Noise Figure vs Frequency**

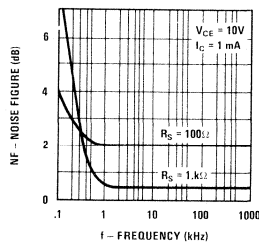

**Contours of Constant Gain Bandwidth Product ( $f_T$ )**

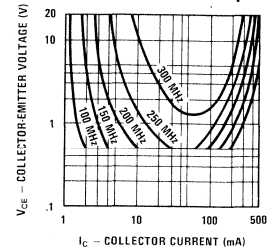



Small Signal Input Resistance vs Collector Current

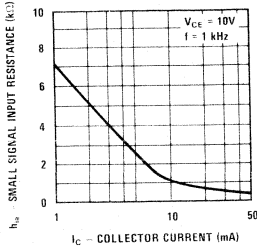

Small Signal Current Gain vs Collector Current

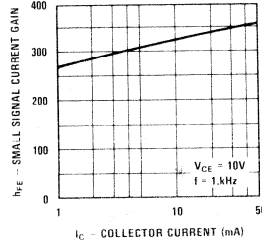

Small Signal Output Conductance vs Collector Current

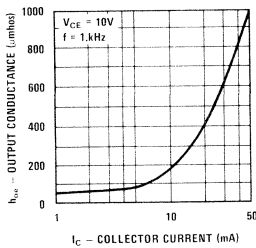

Small Signal Voltage Feedback Ratio vs Collector Current

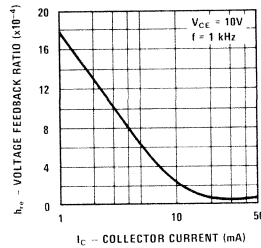

Maximum Power Dissipation vs Ambient Temperature

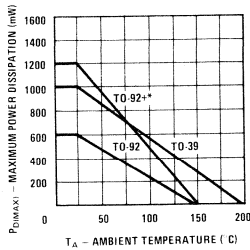

Maximum Power Dissipation vs Case Temperature

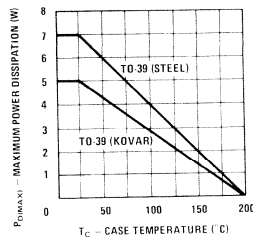

\*One square inch of copper run

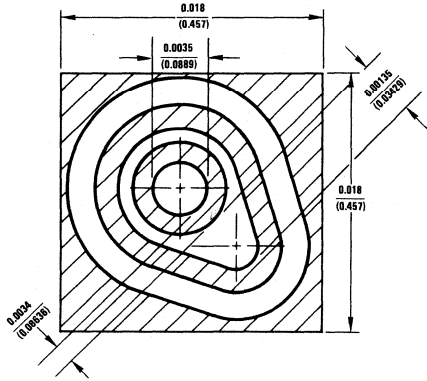

**DESCRIPTION**

Process 62 is a nonoverlay double diffused, silicon epitaxial device. Complement to Process 07.

**APPLICATION**

These devices are designed for low level, high gain, low noise general purpose amplifier applications.

**PRINCIPAL DEVICE TYPES**

- TO-18      2N3550
- TO-46      2N2605
- TO-92      2N5086 (EBC), 2N4058 (ECB)

PARAMETER	TEST CONDITIONS	MIN	TYP	MAX	UNITS	NOTES
NF	$V_{CE} = 5V, I_C = 10 \mu A, R_S = 10 k\Omega, P_{BW} = 15.70 \text{ kHz}$		1.20	3	dB	
$h_{fe}$	$V_{CE} = 5V, I_C = 500 \mu A, f = 20 \text{ MHz}$	5	6			
$C_{eb}$	$V_{EB} = 0.5V$		6	7	pF	
$C_{cb}$	$V_{CB} = 5V$		3.5	5	pF	
$h_{FE}$	$I_C = 10 \mu A, V_{CE} = 5V$	50	200	400		
$h_{FE}$	$I_C = 100 \mu A, V_{CE} = 5V$	50	250	500		
$h_{FE}$	$I_C = 500 \mu A, V_{CE} = 5V$	100	260	600		
$h_{FE}$	$I_C = 1 \text{ mA}, V_{CE} = 5V$	50	270	500		
$h_{FE}$	$I_C = 10 \text{ mA}, V_{CE} = 5V$	50	270	500		
$V_{CE(SAT)}$	$I_C = 1 \text{ mA}, I_B = 0.1 \text{ mA}$		0.05	0.10	V	
$V_{CE(SAT)}$	$I_C = 10 \text{ mA}, I_B = 1 \text{ mA}$		0.08	0.12	V	
$V_{BE(SAT)}$	$I_C = 1 \text{ mA}, I_B = 0.1 \text{ mA}$		0.68	0.70	V	
$V_{BE(SAT)}$	$I_C = 10 \text{ mA}, I_B = 1 \text{ mA}$		0.77	0.90	V	
$BV_{CEO}$	$I_C = 1 \text{ mA}$	35	65	70	V	
$BV_{CBO}$	$I_C = 100 \mu A$	65			V	
$BV_{EBO}$	$I_E = 10 \mu A$	7			V	
$I_{CBO}$	$V_{CB} = 45V$			50	nA	
$I_{EBO}$	$V_{EB} = 5V$			50	nA	

# Process 62

**DC Pulse Current Gain vs Collector Current**

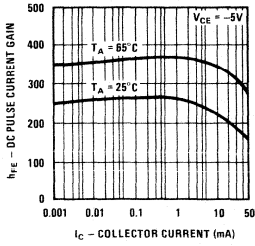

**Base-Emitter On Voltage vs Collector Current**

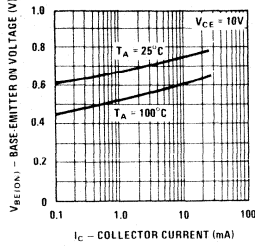

**Maximum Power Dissipation vs Ambient Temperature**

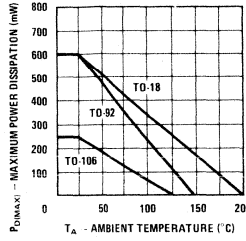

**Maximum Power Dissipation vs Case Temperature**

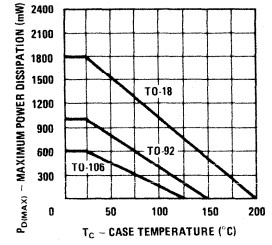

**Collector Cutoff Current vs Ambient Temperature**

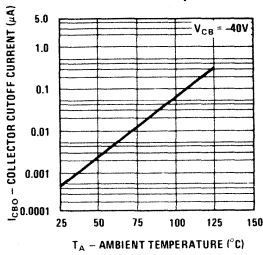

**Collector and Base Saturation Voltage vs Collector Current**

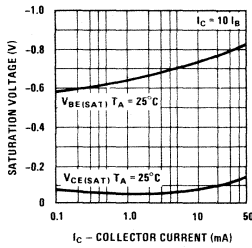

**Input and Output Capacitances vs Reverse Bias Voltage**

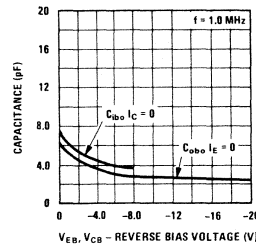

**Contours of Constant Gain Bandwidth Product (fT)**

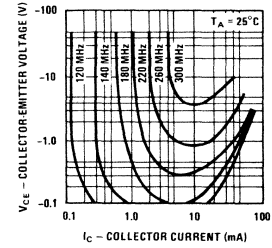

**Collector-Base Diode Leakage Current vs Temperature**

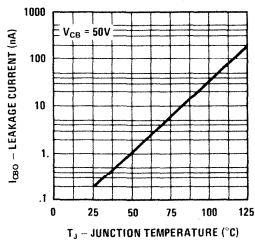

**Contours of Constant Narrow Band Noise Figure**

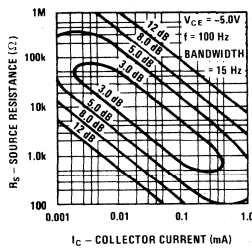

**Contours of Constant Narrow Band Noise Figure**

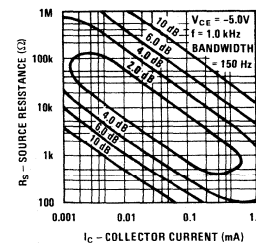

**Contours of Constant Narrow Band Noise Figure**

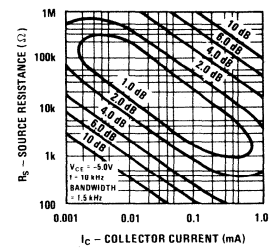

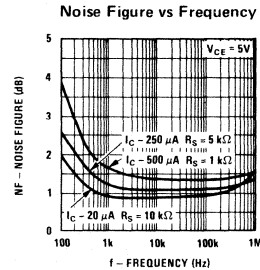
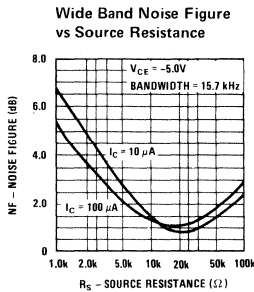
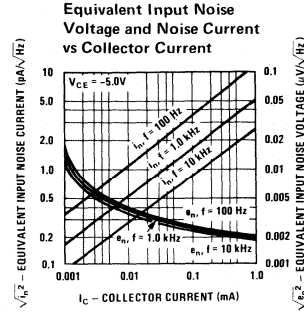
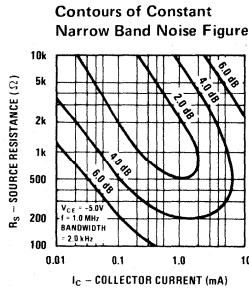

**SMALL SIGNAL CHARACTERISTICS (f = 1.0 kHz)**

SYMBOL	CHARACTERISTIC	MIN.	TYP.	MAX.	UNITS	TEST CONDITIONS
$h_{ie}$	Input Resistance	2.5	8.0	20	$k\Omega$	$I_C = 1.0 \text{ mA}$ $V_{CE} = -5.0\text{V}$
$h_{oe}$	Output Conductance	5.0	19	50	$\mu\text{mho}$	$I_C = 1.0 \text{ mA}$ $V_{CE} = -5.0\text{V}$
$h_{re}$	Voltage Feedback Ratio		10	10	$\times 10^{-4}$	$I_C = 1.0 \text{ mA}$ $V_{CE} = -5.0\text{V}$
$h_{fe}$	Small Signal Current Gain	100	250	800		$I_C = 1.0 \text{ mA}$ $V_{CE} = -5.0\text{V}$

**TYPICAL COMMON EMITTER CHARACTERISTICS (f = 1.0 kHz)**

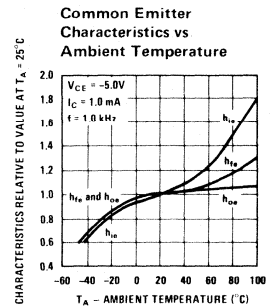
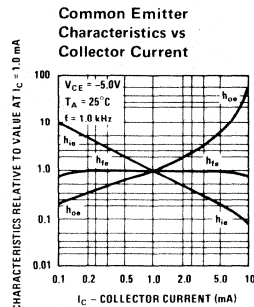
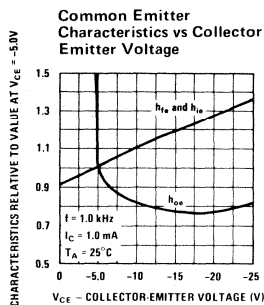

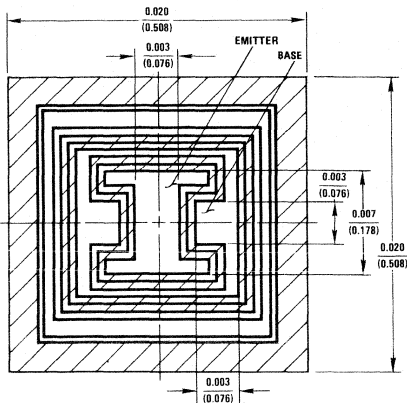
**DESCRIPTION**

Process 63 is a nonoverlay double diffused, silicon epitaxial device. Complement to Process 20.

**APPLICATION**

This device was designed for use as general purpose amplifiers and switches requiring collector currents to 500 mA.

**PRINCIPAL DEVICE TYPES**

TO-5	2N2905A
TO-18	2N2907A
TO-92	2N4403 (ECB), 2N3702 (ECB)
TO-105	2N3645
TO-106	2N4143
TO-92+	TN2905A

PARAMETER	TEST CONDITIONS	MIN	TYP	MAX	UNITS	NOTES
$t_{on}$	$I_C = 150 \text{ mA}$ , $I_{B1} = 15 \text{ mA}$		30	45	ns	Fig. 1
$t_{off}$	$I_C = 150 \text{ mA}$ , $I_{B2} = 15 \text{ mA}$		220	290	ns	Fig. 2
$C_{cb}$	$V_{CB} = 10 \text{ V}$		6	8	pF	TO-18
$C_{eb}$	$V_{EB} = 0.50 \text{ V}$		15	18	pF	TO-18
$h_{fe}$	$I_C = 20 \text{ mA}$ , $V_{CE} = 20 \text{ V}$ , $f = 100 \text{ MHz}$	1.5	2.5			
NF (spot)	$I_C = 100 \mu\text{A}$ , $V_{CE} = 10 \text{ V}$ , $R_S = 1 \text{ k}$ $f = 1 \text{ kHz}$		1.5	3	dB	
$h_{FE}$	$I_C = 1 \text{ mA}$ , $V_{CE} = 10 \text{ V}$	50	140	400		
$h_{FE}$	$I_C = 10 \text{ mA}$ , $V_{CE} = 10 \text{ V}$	50	140	400		
$h_{FE}$	$I_C = 100 \text{ mA}$ , $V_{CE} = 10 \text{ V}$	50	95	400		
$h_{FE}$	$I_C = 150 \text{ mA}$ , $V_{CE} = 10 \text{ V}$	40	150	350		
$h_{FE}$	$I_C = 500 \text{ mA}$ , $V_{CE} = 10 \text{ V}$	40	50	200		
$V_{CE(SAT)}$	$I_C = 150 \text{ mA}$ , $I_B = 15 \text{ mA}$		0.25	0.40	V	
$V_{CE(SAT)}$	$I_C = 500 \text{ mA}$ , $I_B = 50 \text{ mA}$		0.60	1.00	V	
$V_{BE(SAT)}$	$I_C = 150 \text{ mA}$ , $I_B = 15 \text{ mA}$		0.90	1.3	V	
$V_{BE(SAT)}$	$I_C = 500 \text{ mA}$ , $I_B = 50 \text{ mA}$		1.10	1.6	V	
$BV_{CEO}$	$I_C = 10 \text{ mA}$	35	50	65	V	
$BV_{CBO}$	$I_C = 100 \mu\text{A}$	45	70	95	V	
$BV_{CES}$	$I_C = 10 \mu\text{A}$	0.45		90	V	
$BV_{EBO}$	$I_E = 10 \mu\text{A}$	7			V	
$I_{CBO}$	$V_{CB} = 40 \text{ V}$			50	nA	
$I_{EBO}$	$V_{EB} = 3 \text{ V}$			50	nA	

DC Pulse Current Gain vs Collector Current

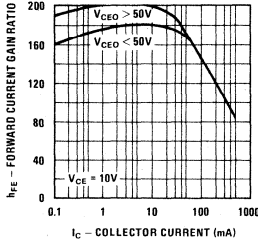

Base-Emitter On Voltage vs Collector Current

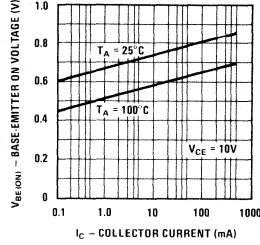

Maximum Power Dissipation vs Ambient Temperature

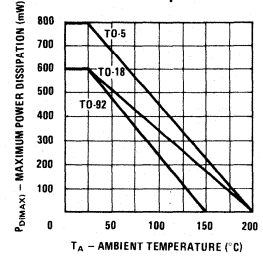

Maximum Power Dissipation vs Case Temperature

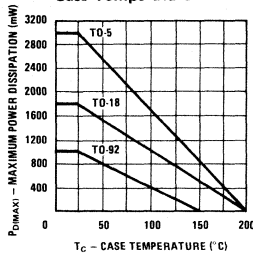

Collector Reverse Current vs Reverse Bias Voltage

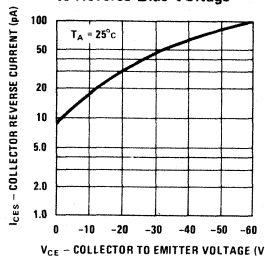

Pulsed Collector Saturation Voltage vs Collector Current

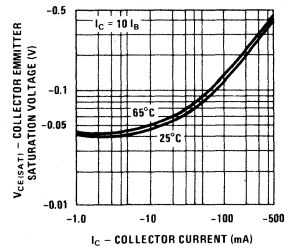

Pulsed Base Saturation Voltage vs Collector Current

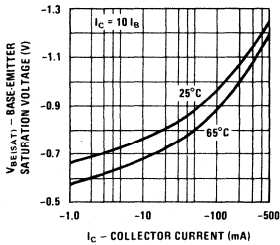

Input and Output Capacitances vs Reverse Bias Voltage

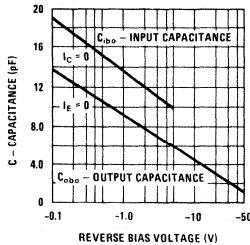

Contours of Constant Gain Bandwidth Product (fT)

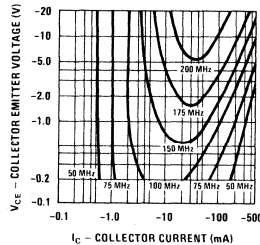

Noise Figure vs Frequency

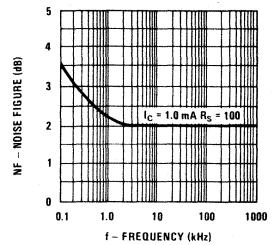

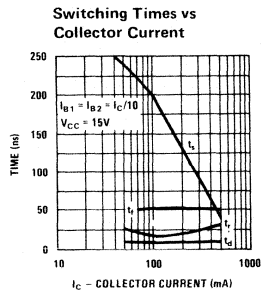

$I_C$  - COLLECTOR CURRENT (mA)

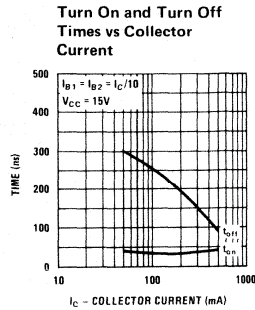

$I_C$  - COLLECTOR CURRENT (mA)

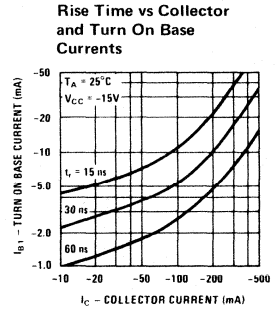

$I_C$  - COLLECTOR CURRENT (mA)

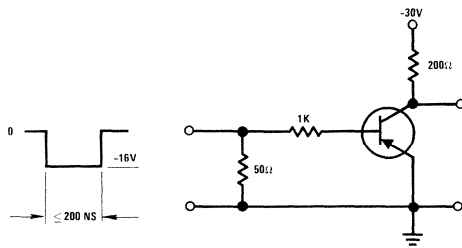

FIGURE 1. Saturated Turn-On Switching Time Test Circuit

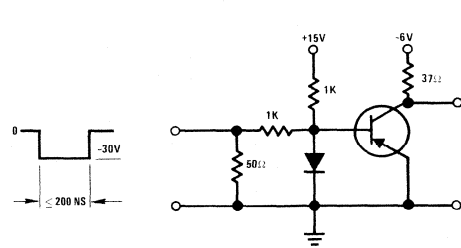
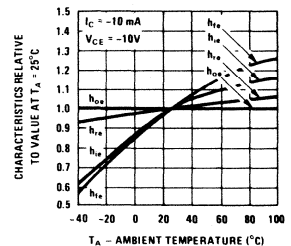
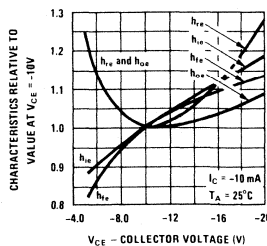
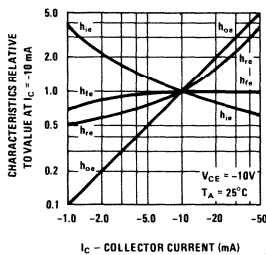

FIGURE 2. Saturated Turn-Off Switching Time Test Circuit

SMALL SIGNAL CHARACTERISTICS ( $f = 1.0 \text{ kHz}$ )

SYMBOL	CHARACTERISTIC	MIN.	TYP.	MAX.	UNITS	TEST CONDITIONS
$h_{ie}$	Input Resistance		480	2000	ohms	$I_C = 10 \text{ mA}$ $V_{CE} = -10\text{V}$
$h_{oe}$	Output Conductance		80	1200	$\mu\text{mhos}$	$I_C = 10 \text{ mA}$ $V_{CE} = -10\text{V}$
$h_{re}$	Voltage Feedback Ratio		162	1500	$\times 10^{-6}$	$I_C = 10 \text{ mA}$ $V_{CE} = -10\text{V}$
$h_{fe}$	Small Signal Current Gain	100				$I_C = 10 \text{ mA}$ $V_{CE} = -10\text{V}$

TYPICAL COMMON EMITTER CHARACTERISTICS ( $f = 1.0 \text{ kHz}$ )



**DESCRIPTION**

Process 64 is an overlay double diffused, gold doped silicon epitaxial device. Complement to Process 22.

**APPLICATION**

This device was designed for high speed saturated switching applications at collector currents to 200 mA.

**PRINCIPAL DEVICE TYPES**

TO-52            2N2894A  
TO-92            PN4313

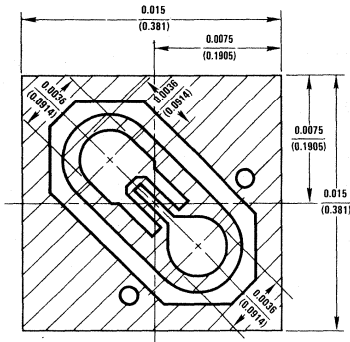

PARAMETER	TEST CONDITIONS	MIN	TYP	MAX	UNITS	NOTES
$t_{on}$	$I_C = 30 \text{ mA}, I_{B1} = 3 \text{ mA}$		10	20	ns	Fig. 1
$t_{off}$	$I_C = 30 \text{ mA}, I_{B2} = 3 \text{ mA}$		21	30	ns	Fig. 1
$t_s$	$I_C = I_{B1} = I_{B2} = 10 \text{ mA}$		15	20	ns	
$C_{ob}$	$V_{CE} = 5V$		3.0	4.5	pF	TO-18
$C_{ib}$	$V_{EB} = 0.5V$		5.0	6.0	pF	TO-18
$h_{fe}$	$f = 100 \text{ MHz}, I_C = 30 \text{ mA}, V_{CE} = 10V$	8	12			
$h_{FE}$	$I_C = 1 \text{ mA}, V_{CE} = 1V$	20	65			
$h_{FE}$	$I_C = 10 \text{ mA}, V_{CE} = 1V$	30	95			
$h_{FE}$	$I_C = 30 \text{ mA}, V_{CE} = 1V$	40	95	130		
$h_{FE}$	$I_C = 100 \text{ mA}, V_{CE} = 1V$	30	85			
$V_{CE(SAT)}$	$I_C = 10 \text{ mA}, I_B = 1 \text{ mA}$		0.08	0.15	V	
$V_{CE(SAT)}$	$I_C = 30 \text{ mA}, I_B = 3 \text{ mA}$		0.11	0.19	V	
$V_{CE(SAT)}$	$I_C = 100 \text{ mA}, I_B = 10 \text{ mA}$		0.28	0.45	V	
$V_{BE(SAT)}$	$I_C = 10 \text{ mA}, I_B = 1 \text{ mA}$		0.80	0.92	V	
$V_{BE(SAT)}$	$I_C = 30 \text{ mA}, I_B = 3 \text{ mA}$		0.90	1.15	V	
$V_{BE(SAT)}$	$I_C = 100 \text{ mA}, I_B = 10 \text{ mA}$		1.10	1.50	V	
$BV_{CEO}$	$I_C = 10 \text{ mA}$	12		15	V	
$BV_{CBO}$	$I_C = 100 \mu\text{A}$	12		15	V	
$BV_{EBO}$	$I_E = 10 \mu\text{A}$	4.5			V	
$I_{CES}$	$V_{CE} = 10V$			50	nA	



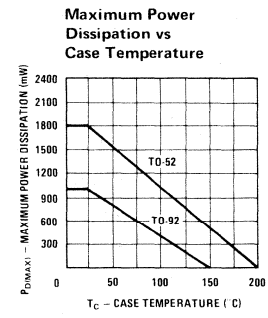
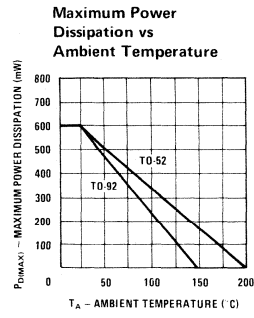
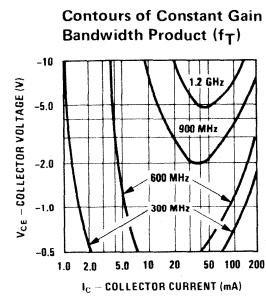
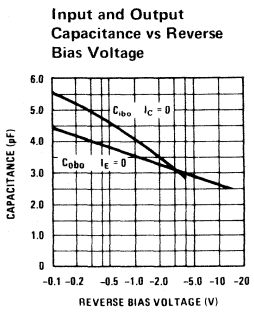
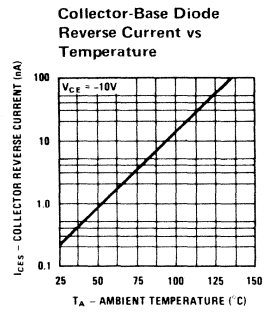
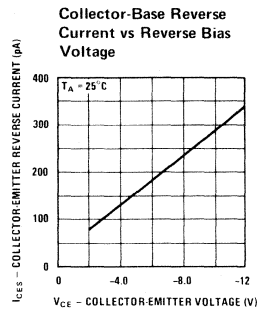
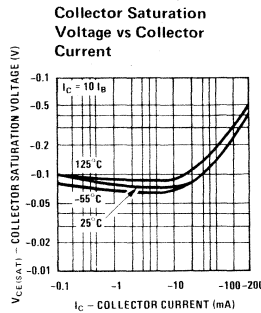
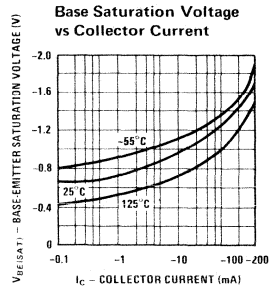
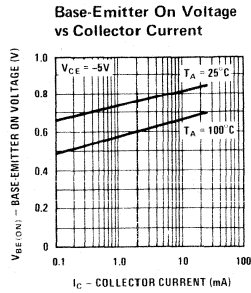
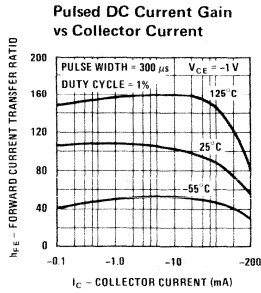

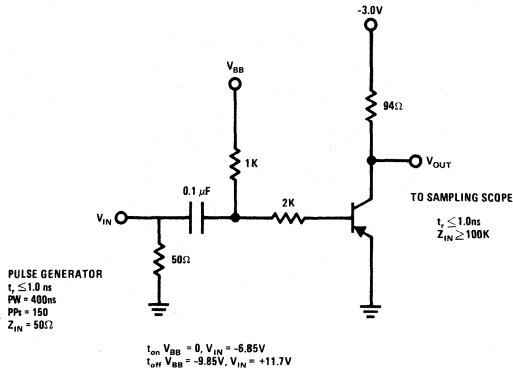
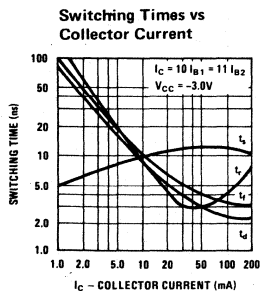
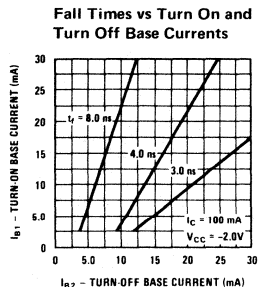
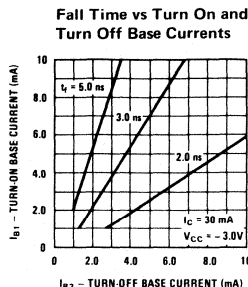
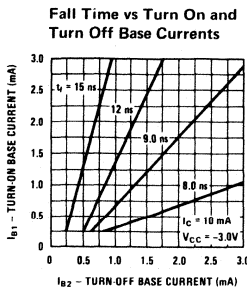
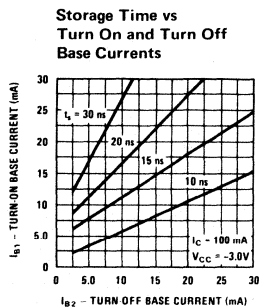
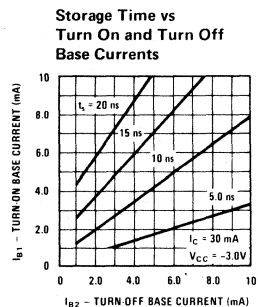
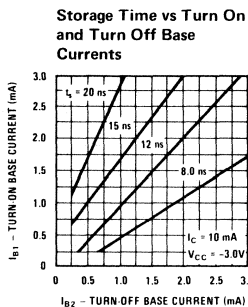
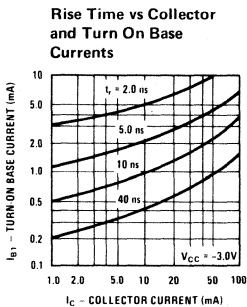
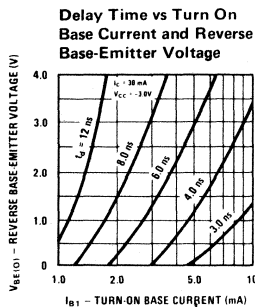
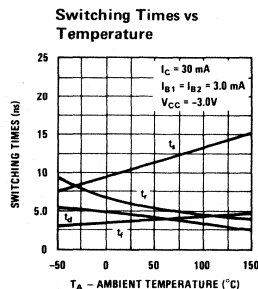
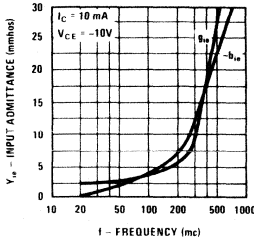

FIGURE 1. Switching Time Test Circuit



COMMON EMITTER VS FREQUENCY Y PARAMETERS

Input Admittance vs Frequency-Output Short Circuit



Output Admittance vs Frequency-Input Short Circuit

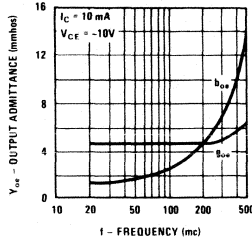

Forward Transfer Admittance vs Frequency-Output Short Circuit

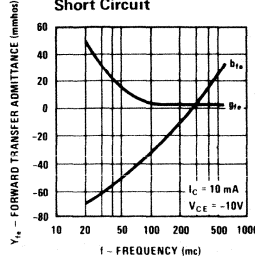

Input Admittance vs Collector Current and Voltage-Output Short Circuit

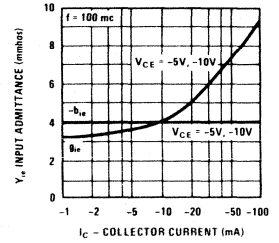

Output Admittance vs Collector Current and Voltage-Input Short Circuit

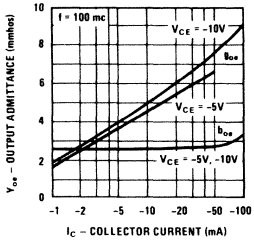

Forward Transfer Admittance vs Collector Current and Voltage-Output Short Circuit

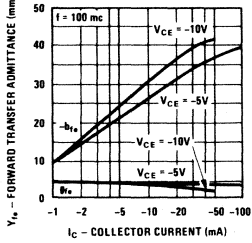

Reverse Transfer Admittance vs Frequency-Input Short Circuit

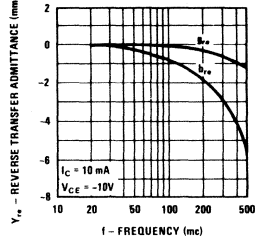

Reverse Transfer Admittance vs Collector Current and Voltage-Input Short Circuit

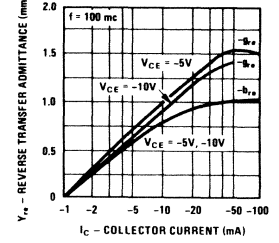

Noise Figure vs Source Resistance and Collector Current

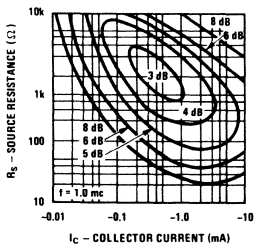

Noise Figure vs Frequency

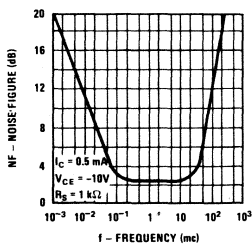

M.A.G. vs Frequency

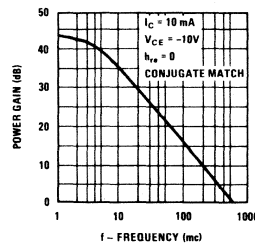

Propagation Delay Time vs Collector Supply Voltage

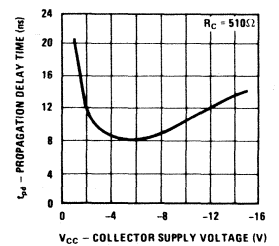

**DESCRIPTION**

Process 65 is an overlay double diffused, gold doped, silicon epitaxial device.

**APPLICATION**

This device was designed for very high speed saturate switching at collector currents to 50 mA.

**PRINCIPAL DEVICE TYPES**

TO-18 2N4208  
TO-92 MPS3640, 2N5771

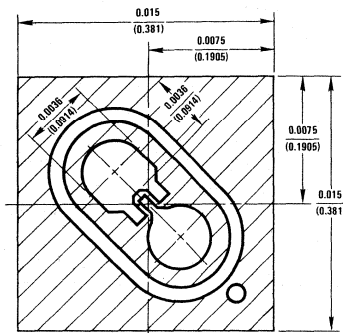

PARAMETER	TEST CONDITIONS	MIN	TYP	MAX	UNITS	NOTES
$t_{off}$	$I_C = 10 \text{ mA}, I_{B2} = 1 \text{ mA}$		18	25	ns	Fig. 1
$t_{on}$	$I_C = 10 \text{ mA}, I_{B1} = 1 \text{ mA}$		11	15	ns	Fig. 1
$t_s$	$I_C = I_{B1} = I_{B2} = 10 \text{ mA}$		15	20	ns	
$C_{ob}$	$V_{CB} = 5V$		2	3	pF	TO-18
$C_{ib}$	$V_{EB} = .5V$		2.5	3.5	pF	
$h_{fe}$	$V_{CE} = 10V, I_C = 10 \text{ mA}, f = 100 \text{ MHz}$	6.5	9			
$h_{fe}$	$I_C = 1 \text{ mA}, V_{CE} = 1V$	20	60			
$h_{fe}$	$I_C = 10 \text{ mA}, V_{CE} = 1V$	30	85	120		
$h_{fe}$	$I_C = 50 \text{ mA}, V_{CE} = 1V$	20	75			
$h_{fe}$	$I_C = 100 \text{ mA}, V_{CE} = 1V$	20	60			
$h_{fe}$	$I_C = 1 \text{ mA}, V_{CE} = .5V$	20	60			
$h_{fe}$	$I_C = 10 \text{ mA}, V_{CE} = .3V$	20	67	150		
$h_{fe}$	$I_C = 50 \text{ mA}, V_{CE} = 1.0V$	20	60			
$V_{CE(SAT)}$	$I_C = 1 \text{ mA}, I_B = .1 \text{ mA}$		0.10	0.13	V	
$V_{CE(SAT)}$	$I_C = 10 \text{ mA}, I_B = 1 \text{ mA}$		0.12	0.15	V	
$V_{CE(SAT)}$	$I_C = 50 \text{ mA}, I_B = 5 \text{ mA}$		0.25	0.50	V	
$V_{BE(SAT)}$	$I_C = 1 \text{ mA}, I_B = .1 \text{ mA}$		0.73	0.8	V	
$V_{BE(SAT)}$	$I_C = 10 \text{ mA}, I_B = 1 \text{ mA}$		0.88	0.95	V	
$V_{BE(SAT)}$	$I_C = 50 \text{ mA}, I_B = 5 \text{ mA}$		1.00	1.5	V	
$BV_{CEO}$	$I_C = 3 \text{ mA}$	12	15	20	V	
$BV_{CBO}$	$I_C = 100 \mu\text{A}$	25	30	40	V	
$BV_{EBO}$	$I_C = 10 \mu\text{A}$	4.5			V	
$I_{CBO}$	$V_{CB} = 3V$			50	nA	

# Process 65

**DC Pulse Current Gain vs Collector Current**

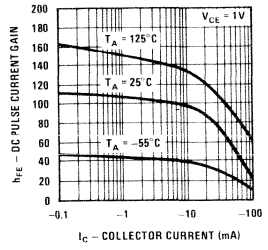

**Base-Emitter On Voltage vs Collector Current**

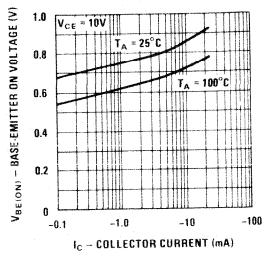

**Base Saturation Voltage vs Collector Current**

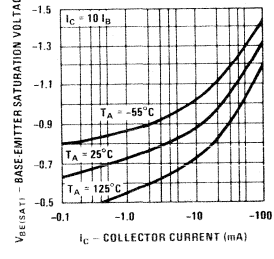

**Collector Saturation Voltage vs Collector Current**

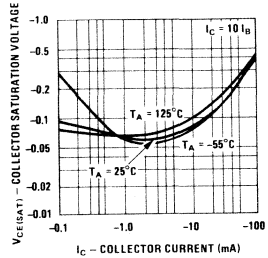

**Collector Reverse Current vs Collector-Emitter Voltage**

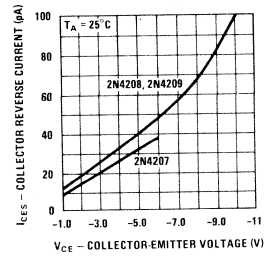

**Collector Reverse Current vs Ambient Temperature**

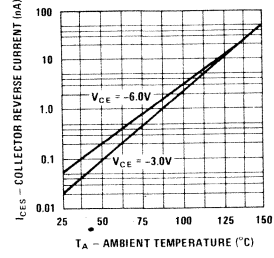

**Input and Output Capacitance vs Reverse Bias Voltage**

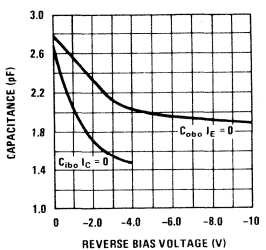

**Contours of Constant Gain Bandwidth Product (fT)**

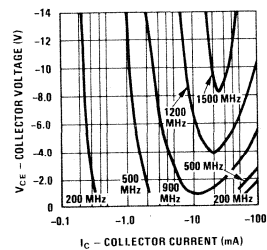

**Maximum Power Dissipation vs Ambient Temperature**

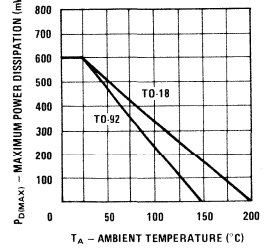

**Maximum Power Dissipation vs Case Temperature**

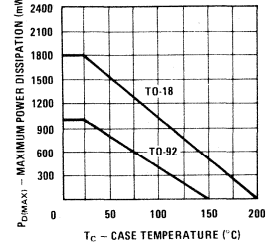

Switching Times vs Collector Current

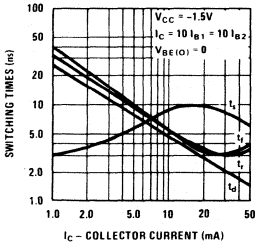

Switching Times vs Ambient Temperature

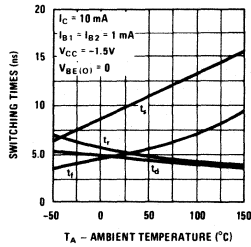

Delay Time vs Turn On Base Current and Reverse Base-Emitter Voltage

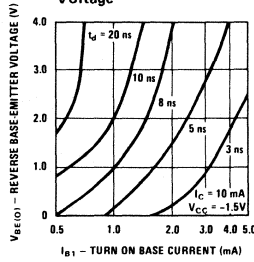

Rise Time vs Collector and Turn On Base Currents

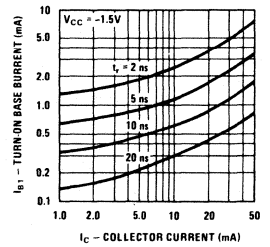

Storage Time vs Turn On and Turn Off Base Currents

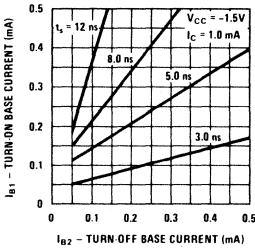

Storage Time vs Turn On and Turn Off Base Currents

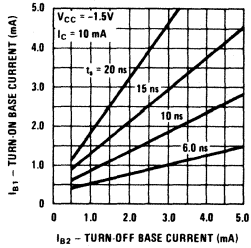

Storage Time vs Turn On and Turn Off Base Currents

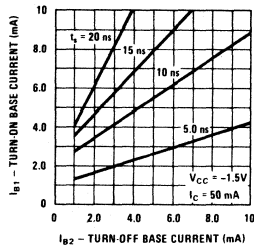

Fall Time vs Turn On and Turn Off Base Currents

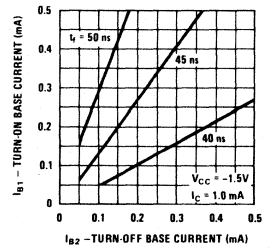

Fall Time vs Turn On and Turn Off Base Currents

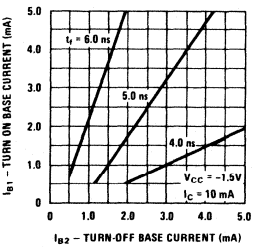

Fall Time vs Turn On and Turn Off Base Currents

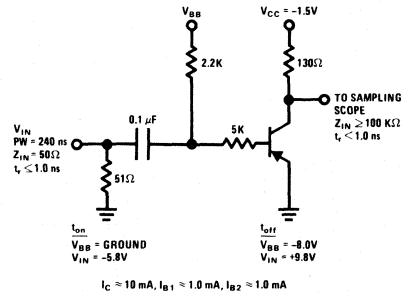
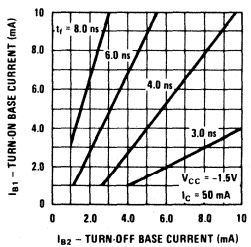

FIGURE 1.  $t_{on}$  and  $t_{off}$  Test Circuit

**DESCRIPTION**

Process 66 is a nonoverlay double diffused, gold doped, silicon epitaxial device. Complement to Process 23.

**APPLICATION**

This device was designed for general purpose amplifier and switching applications at collector currents of 10  $\mu$ A to 100 mA.

**PRINCIPAL DEVICE TYPES**

TO-92          2N3906

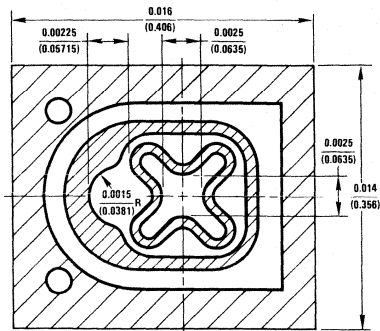

PARAMETER	TEST CONDITIONS	MIN	TYP	MAX	UNITS	NOTES
$t_{off}$	$I_C = 10 \text{ mA}$ , $I_{B2} = 1 \text{ mA}$		125	300	ns	
$t_{on}$	$I_C = 10 \text{ mA}$ , $I_{B1} = 1 \text{ mA}$		30	70	ns	
$C_{ob}$	$V_{CB} = 5\text{V}$		3.0	4.5	pF	TO-92
$C_{ib}$	$V_{EB} = 0.5\text{V}$		6.0	10.0	pF	TO-92
$h_{fe}$	$f = 100 \text{ MHz}$ , $V_{CE} = 20\text{V}$ , $I_C = 10 \text{ mA}$	2.5	6.0			
NF (wide band)	$I_C = 100 \mu\text{A}$ , $V_{CE} = 5\text{V}$ , $R_S = 1 \text{ k}\Omega$		2.0	4.0	dB	
$h_{fe}$	$I_C = 0.1 \text{ mA}$ , $V_{CE} = 1\text{V}$	40	80			
$h_{fe}$	$I_C = 1 \text{ mA}$ , $V_{CE} = 1\text{V}$	50	120			
$h_{fe}$	$I_C = 10 \text{ mA}$ , $V_{CE} = 1\text{V}$	50	150	300		
$h_{fe}$	$I_C = 50 \text{ mA}$ , $V_{CE} = 1\text{V}$	40	110			
$h_{fe}$	$I_C = 100 \text{ mA}$ , $V_{CE} = 1\text{V}$	20	40			
$V_{CE(SAT)}$	$I_C = 10 \text{ mA}$ , $I_B = 1 \text{ mA}$		0.07	0.25	V	
$V_{CE(SAT)}$	$I_C = 50 \text{ mA}$ , $I_B = 5 \text{ mA}$		0.12	0.40	V	
$V_{BE(SAT)}$	$I_C = 10 \text{ mA}$ , $I_B = 1 \text{ mA}$		0.75	0.85	V	
$V_{BE(SAT)}$	$I_C = 50 \text{ mA}$ , $I_B = 5 \text{ mA}$		0.85	0.95	V	
$BV_{CEO}$	$I_C = 1 \text{ mA}$	30	45	60	V	
$BV_{CBO}$	$I_C = 100 \mu\text{A}$	45		70	V	
$BV_{CES}$	$I_C = 10 \mu\text{A}$	45		70	V	
$BV_{EBO}$	$I_C = 10 \mu\text{A}$	5.0			V	
$I_{CBO}$	$V_{CB} = 25\text{V}$			50	nA	
$I_{EBO}$	$V_{EB} = 4\text{V}$			50	nA	

DC Pulse Current Gain vs Collector Current

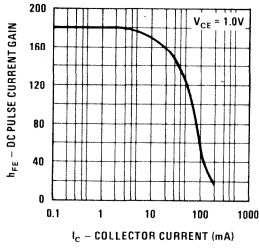

Base-Emitter On Voltage vs Collector Current

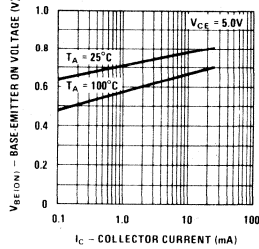

Maximum Power Dissipation vs Ambient Temperature TO-92

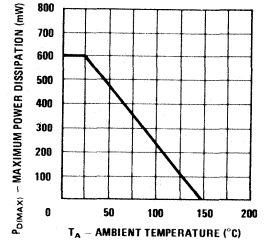

Maximum Power Dissipation vs Case Temperature TO-92

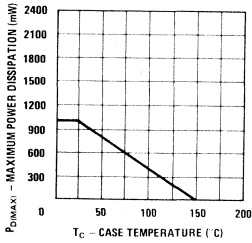

Collector-Emitter Saturation Voltage vs Collector Current

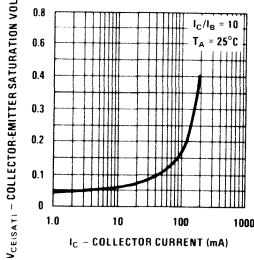

Base-Emitter Saturation Voltage vs Collector Current

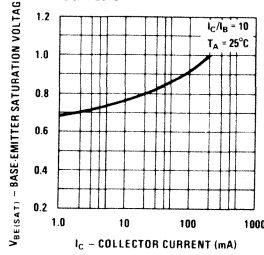

Contours of Constant Gain Bandwidth Product (f\_T)

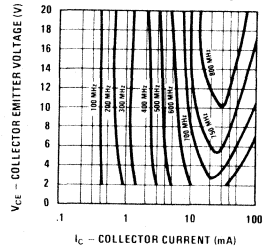

Collector-Base Diode Reverse Current vs Temperature

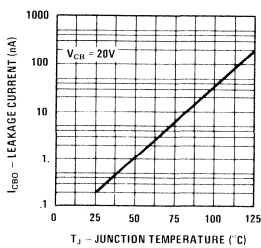

Common Base Open Circuit Input and Output Capacitance vs Reverse Bias Voltage

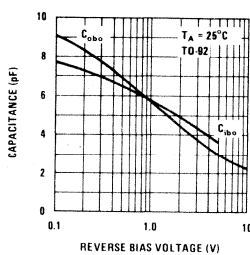

Noise Figure vs Frequency

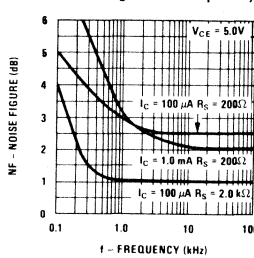

Noise Figure vs Source Resistance

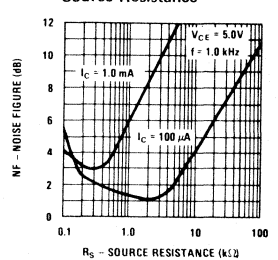



Input Impedance

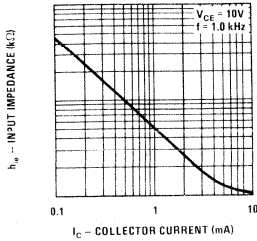

Output Admittance

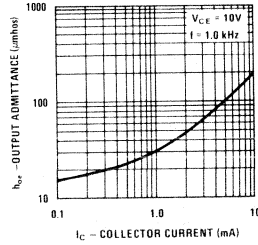

Current Gain

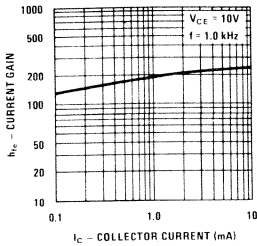

Voltage Feedback Ratio

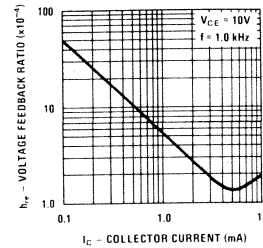

Turn On and Turn Off Times vs Collector Current

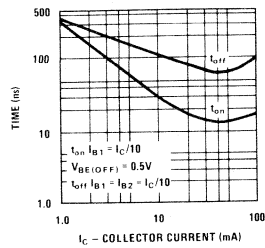

Switching Times vs Collector Current

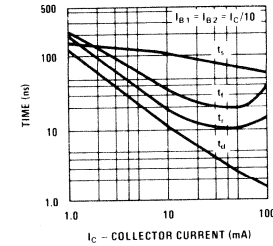

### DESCRIPTION

Process 67 is a nonoverlay double diffused silicon device. Complement to Process 12.

### APPLICATION

This device is designed for general purpose amplifier and switching applications at currents to one amp.

### PRINCIPAL DEVICE TYPES

TO-39	2N4033
TO-92	MPS4356, MPSA55
TO-92+	TN4033

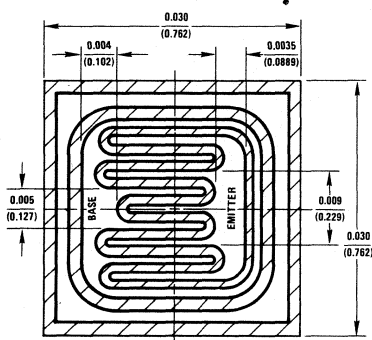

PARAMETER	TEST CONDITIONS	MIN	TYP	MAX	UNITS	NOTES
$t_{on}$	$I_C = 500 \text{ mA}, I_{B1} = 50 \text{ mA}$	20	25	60	ns	
$t_{off}$	$I_C = 500 \text{ mA}, I_{B2} = 50 \text{ mA}$	200	250	400	ns	
$C_{ob}$	$V_{CB} = 10\text{V}$		11	15	pF	TO-39
$C_{ib}$	$V_{EB} = 0.50\text{V}$		65	90	pF	TO-39
$h_{fe}$	$V_{CE} = 10\text{V}, I_C = 50 \text{ mA}, f = 100 \text{ MHz}$	1.5	2			
NF (spot)	$I_C = 100 \mu\text{A}, R_S = 1\text{k}, V_{CE} = 10\text{V}, f = 1 \text{ kHz}$		0.5	4	dB	
$h_{FE}$	$I_C = 0.10 \text{ mA}, V_{CE} = 10\text{V}$	36	135			
$h_{FE}$	$I_C = 1.0 \text{ mA}, V_{CE} = 10\text{V}$	40	145			
$h_{FE}$	$I_C = 10 \text{ mA}, V_{CE} = 10\text{V}$	42	160	370		
$h_{FE}$	$I_C = 100 \text{ mA}, V_{CE} = 10\text{V}$	40	150	350		
$h_{FE}$	$I_C = 500 \text{ mA}, V_{CE} = 10\text{V}$	35	130			
$h_{FE}$	$I_C = 1\text{A}, V_{CE} = 10\text{V}$	25	100			
$V_{CE(SAT)}$	$I_C = 150 \text{ mA}, I_B = 15 \text{ mA}$		0.15	0.2	V	
$V_{CE(SAT)}$	$I_C = 500 \text{ mA}, I_B = 50 \text{ mA}$		0.4	0.5	V	
$V_{BE(SAT)}$	$I_C = 150 \text{ mA}, I_B = 15 \text{ mA}$		0.8	1.0	V	
$V_{BE(SAT)}$	$I_C = 500 \text{ mA}, I_B = 50 \text{ mA}$		0.95	1.2	V	
$BV_{CEO}$	$I_C = 10 \text{ mA}$	60	80	90	V	
$BV_{CBO}$	$I_C = 100 \mu\text{A}$	80	120		V	
$BV_{EBO}$	$I_E = 10 \mu\text{A}$	6			V	
$I_{CBO}$	$V_{CB} = 60\text{V}$			50	nA	
$I_{EBO}$	$V_{EB} = 4\text{V}$			50	nA	

# Process 67

**DC Pulse Current Gain vs Collector Current**

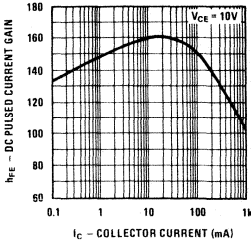

**Base-Emitter On Voltage vs Collector Current**

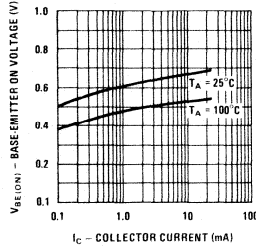

**Maximum Power Dissipation vs Ambient Temperature**

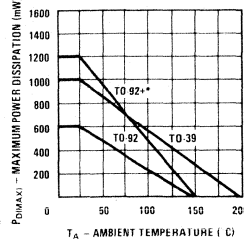

**Maximum Power Dissipation vs Case Temperature**

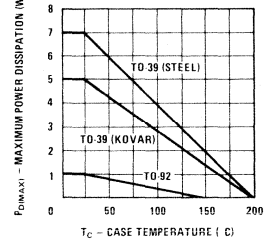

**Safe Operating Area TO-39 With 'Wake Field' Type 296-4 Heat Sink**

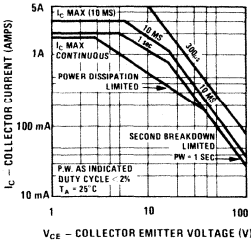

**Gain Bandwidth Product vs Collector Current**

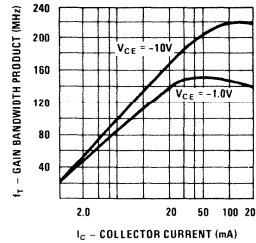

\*One square inch of copper run

**Common Base Open Circuit Input and Output Capacitance vs Reverse Bias Voltage**

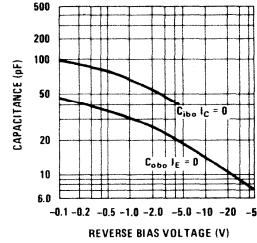

**Collector-Emitter Saturation Voltage vs Collector Current**

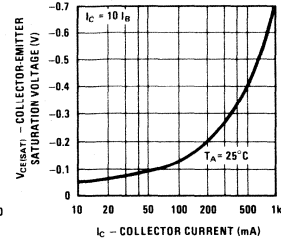

**Base-Emitter Saturation Voltage vs Collector Current**

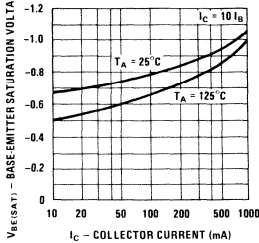

**Noise Figure vs Collector Current**

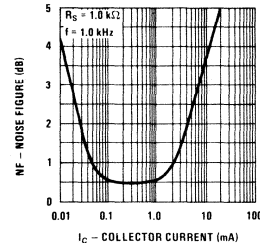

**Noise Figure vs Frequency**

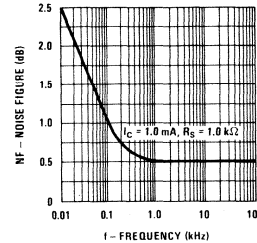

**Switching Times vs Collector Current**

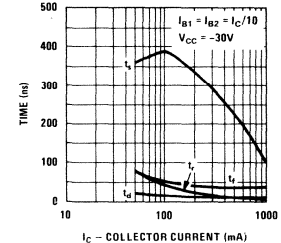

**Turn On and Turn Off Times vs Collector Current**

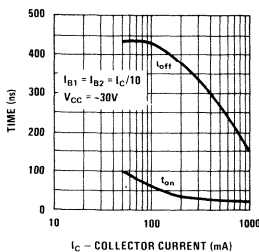

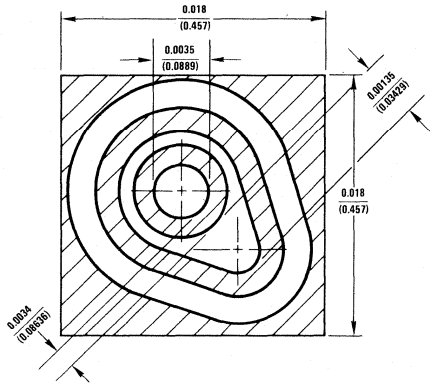

## DESCRIPTION

Process 69 is a nonoverlay double diffused, silicon epitaxial device. Complements Process 27.

## APPLICATION

This device was designed for general purpose amplifier and switching applications to collector currents of 100 mA.

## PRINCIPAL DEVICE TYPES

TO-18      2N3251A

PARAMETER	TEST CONDITIONS	MIN	TYP	MAX	UNITS	NOTES
$T_{ON}$	$I_C = 10 \text{ mA}, I_B = 1 \text{ mA}$		50	70	ns	
$T_{OFF}$	$I_C = 10 \text{ mA}, I_B = 1 \text{ mA}$		125	225	ns	
NF	$V_{CE} = 5V, I_C = 100 \mu A, f = 1 \text{ kHz}$ $R_S = 1 \text{ k}\Omega$		1.7	4.5	dB	
$C_{OB}$	$V_{CE} = 5V$		4	5.0	pF	
$C_{IB}$	$V_{EB} = 1V$		6.5	8.0	pF	
$f_T$	$V_{CE} = 20V, I_C = 10 \text{ mA}$	250	450		MHz	
$h_{FE}$	$V_{CE} = 1V, I_C = 100 \mu A$	40	150	270		
$h_{FE}$	$V_{CE} = 1V, I_C = 1 \text{ mA}$	55	175	315		
$h_{FE}$	$V_{CE} = 1V, I_C = 10 \text{ mA}$	50	150	270		
$h_{FE}$	$V_{CE} = 1V, I_C = 50 \text{ mA}$	15	85	150		
$h_{FE}$	$V_{CG} = 1V, I_C = 100 \text{ mA}$		18	35		
$V_{CE(SAT)}$	$I_C = 10 \text{ mA}, I_B = 1 \text{ mA}$		0.15	0.25	V	
$V_{CE(SAT)}$	$I_C = 50 \text{ mA}, I_B = 5 \text{ mA}$		0.25	0.50	V	
$V_{BE(SAT)}$	$I_C = 10 \text{ mA}, I_B = 1 \text{ mA}$		0.74	0.90	V	
$V_{BE(SAT)}$	$I_C = 50 \text{ mA}, I_B = 5 \text{ mA}$		0.90	1.20	V	
$I_{CBO}$	$V_{CB} = 30V$		1.5	50	nA	
$I_{EBO}$	$V_{EB} = 4V$		0.05	50	nA	
$BV_{CBO}$	$I_C = 10 \mu A$	50	70	95		
$BV_{EBO}$	$I_C = 10 \mu A$	5.0				
$BV_{CEO}$	$I_C = 1 \text{ mA}$	40	50	60		
$BV_{CES}$	$I_C = 10 \mu A$		70			

# Process 69

**DC Pulsed Current Gain vs Collector Current**

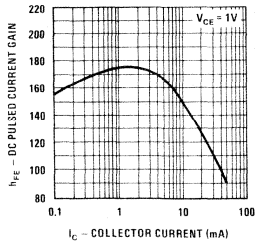

**Base-Emitter On Voltage vs Collector Current**

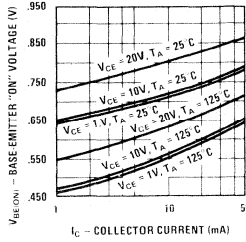

**Maximum Power Dissipation vs Ambient Temperature**

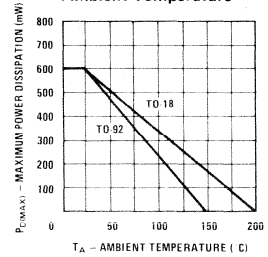

**Maximum Power Dissipation vs Case Temperature**

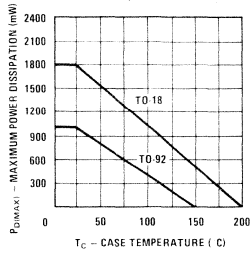

**Collector-Base Diode Reverse Current vs Temperature**

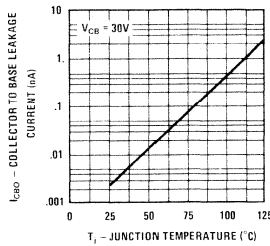

**Collector-Emitter Saturation Voltage vs Collector Current**

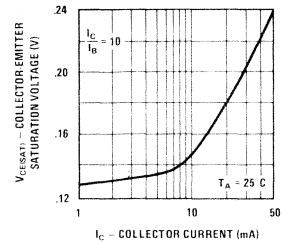

**Base-Emitter On Voltage vs Collector Current**

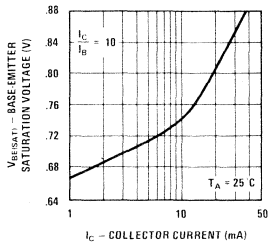

**Output Capacitance vs Reverse Bias Voltage**

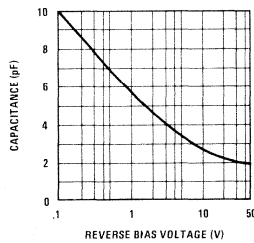

**Input Capacitance vs Reverse Bias Voltage**

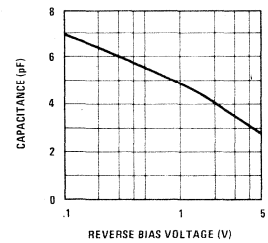

**Contours of Constant Gain Bandwidth Product (fT)**

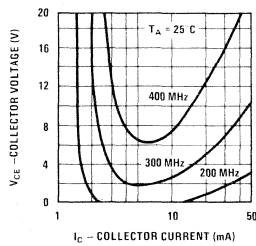

**Rb'cc vs Collector Current**

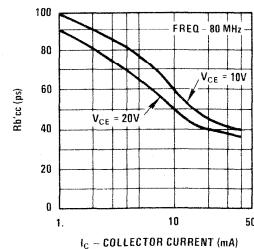

**Noise Figure vs Frequency**

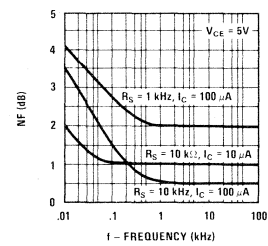

Noise Figure vs Collector Current

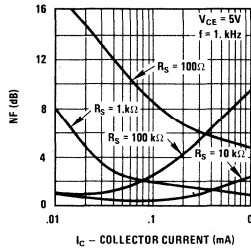

Small Signal Input Resistance vs Collector Current

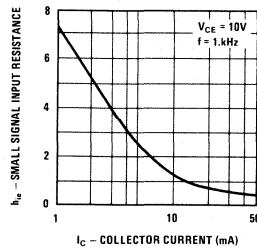

Small Signal Current Gain vs Collector Current

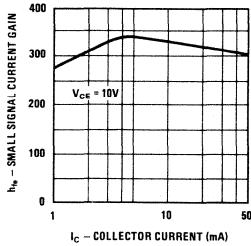

Small Signal Voltage Feedback Ratio vs Collector Current

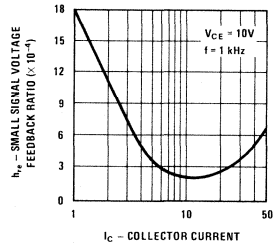

Small Signal Output Conductance vs Collector Current

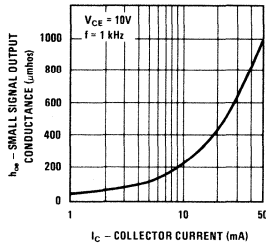

Turn On and Turn Off Times vs Collector Current

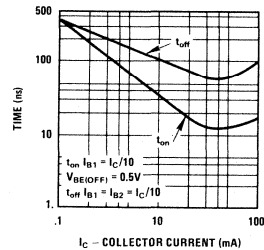

Switching Times vs Collector Current

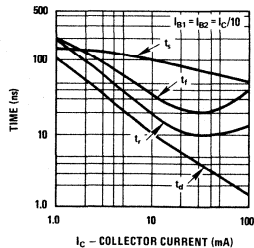

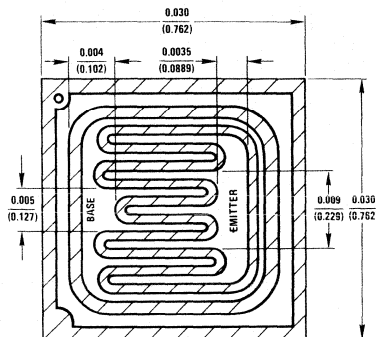
**DESCRIPTION**

Process 70 is a nonoverlay double diffused, gold doped, silicon epitaxial device. Complement to process 25.

**APPLICATION**

This device was designed primarily for high speed saturated switching applications.

**PRINCIPAL DEVICE TYPES**

TO-39            2N3467  
TO-92+         TN3467

PARAMETER	TEST CONDITIONS	MIN	TYP	MAX	UNITS	NOTES
$t_{ON}$	$I_C = 500 \text{ mA}$ , $I_{B1} = 50 \text{ mA}$		20	40	ns	Fig. 1
$t_{OFF}$	$I_C = 500 \text{ mA}$ , $I_{B2} = 50 \text{ mA}$		60	90	ns	Fig. 2
$h_{fe}$	$I_C = 50 \text{ mA}$ , $V_{CE} = -10\text{V}$ , $f = 100 \text{ MHz}$	1.75	2.9			
$C_{ob}$	$V_{CB} = -10\text{V}$		15	20	pF	
$C_{ib}$	$V_{eb} = -0.5\text{V}$		65	80	pF	
$h_{FE}$	$I_C = 100 \text{ mA}$ , $V_{CE} = -1\text{V}$	40	100	200		
$h_{FE}$	$I_C = 500 \text{ mA}$ , $V_{CE} = -1\text{V}$	40	75	120		
$h_{FE}$	$I_C = 1 \text{ Amp}$ , $V_{CE} = -1\text{V}$	40	85			
$V_{CE(SAT)}$	$I_C = 150 \text{ mA}$ , $I_B = 15 \text{ mA}$		0.165	0.3	V	
$V_{CE(SAT)}$	$I_C = 500 \text{ mA}$ , $I_B = 50 \text{ mA}$		0.30	0.5	V	
$V_{CE(SAT)}$	$I_C = 1 \text{ Amp}$ , $I_B = 100 \text{ mA}$		0.50	1.0	V	
$V_{BE(SAT)}$	$I_C = 150 \text{ mA}$ , $I_B = 15 \text{ mA}$		0.80	1.0	V	
$V_{BE(SAT)}$	$I_C = 500 \text{ mA}$ , $I_B = 50 \text{ mA}$		0.95	1.2	V	
$V_{BE(SAT)}$	$I_C = 1 \text{ Amp}$ , $I_B = 100 \text{ mA}$		1.1	1.6	V	
$BV_{CEO}$	$I_C = 10 \text{ mA}$	30	40	50	V	
$BV_{CBO}$	$I_C = 10 \mu\text{A}$	40	60	80	V	
$BV_{EBO}$	$I_E = 10 \mu\text{A}$	5	8.0		V	
$I_{CBO}$	$V_{CB} = 30\text{V}$		10	100	nA	
$I_{CEX}$	$V_{CE} = -30\text{V}$ , $V_{BE(OFF)} = 3\text{V}$		10	100	nA	
$I_{bL}$	$V_{CE} = -30\text{V}$ , $V_{BE(OFF)} = 3\text{V}$		10	120	nA	

DC Pulse Current Gain vs Collector Current

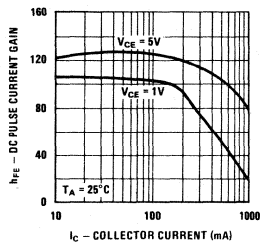

Collector-Emitter Saturation Voltage vs Collector Current

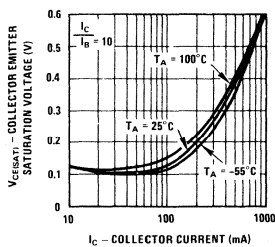

Base-Emitter Saturation Voltage vs Collector Current

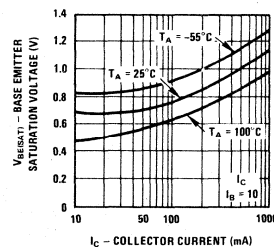

Input & Output Capacitance vs Reverse Bias Voltage

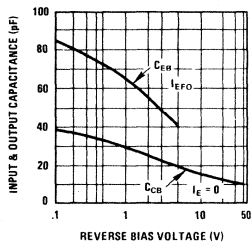

BVCEr vs RBE IC = 10 mA

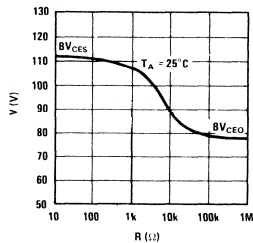

Delay Time vs Turn On Base Current and Reverse Base Emitter Voltage

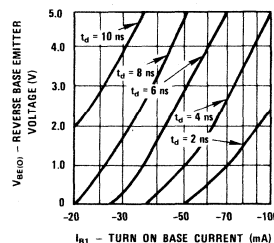

Storage Time vs Turn On and Turn Off Base Currents

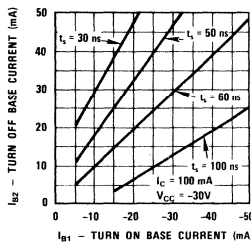

Storage Time vs Turn On and Turn Off Base Currents

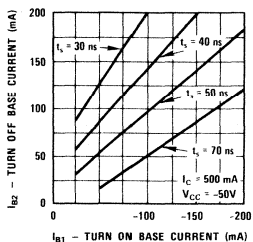

Fall Time vs Turn On and Turn Off Base Currents

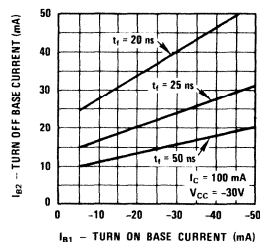

Fall Time vs Turn On and Turn Off Base Currents

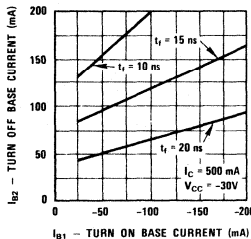

Switching Times vs Ambient Temperature

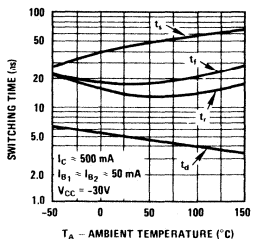

Rise Time vs Collector Current and Turn On Base Current

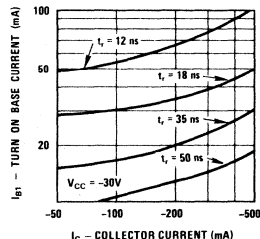



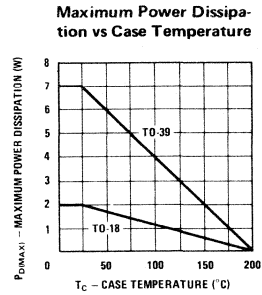
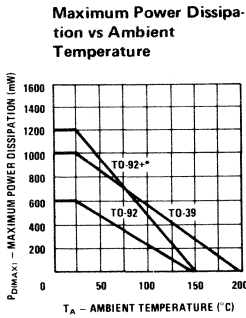
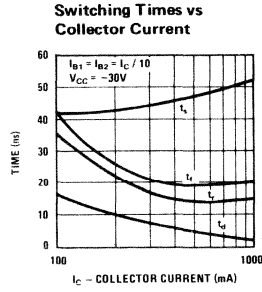
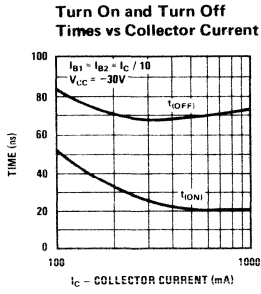

\*One square inch of copper run

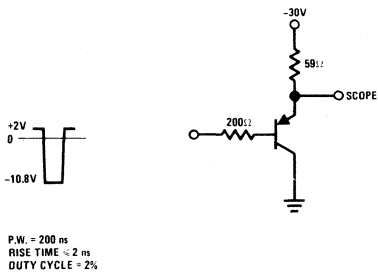

FIGURE 1.  $t_{ON}$  Equivalent Test Circuit

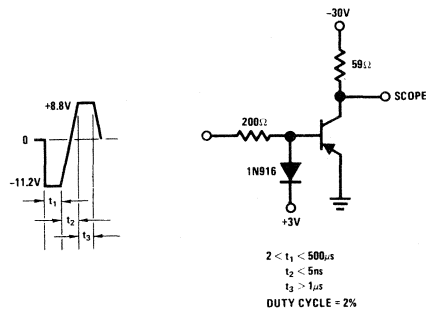
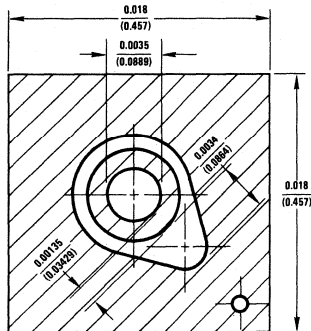

FIGURE 2.  $t_{OFF}$  Equivalent Test Circuit



## DESCRIPTION

Process 71 is a nonoverlay, double diffused, silicon device. Complement to Process 04.

## APPLICATION

This device was designed for general purpose amplifier applications at collector currents to 20 mA.

## PRINCIPAL DEVICE TYPES

TO-18      BC177 Series  
TO-92      BC560 Series

PARAMETER	TEST CONDITIONS	MIN	TYP	MAX	UNITS	NOTES
NF (spot)	$I_C = 200 \mu A$ , $V_C = 5V$ , $R_S = 2k$ , $f = 1 \text{ kHz}$		0.5	2.50	dB	
$h_{fe}$	$I_C = 10 \text{ mA}$ , $V_{CE} = 5V$ , $f = 100 \text{ MHz}$	3	5			
$C_{ob}$	$V_{CB} = 10V$		4	6	pF	TO-18
$C_{ib}$	$V_{EB} = 0.50V$		8	12	pF	TO-18
$h_{FE}$	$I_C = 100 \mu A$ , $V_{CE} = 5V$	40	140	400		
$h_{FE}$	$I_C = 1 \text{ mA}$ , $V_{CE} = 5V$	40	140	400		
$h_{FE}$	$I_C = 10 \text{ mA}$ , $V_{CE} = 5V$	40	130			
$h_{FE}$	$I_C = 20 \text{ mA}$ , $V_{CE} = 5V$	40	125			
$V_{CE(SAT)}$	$I_C = 1 \text{ mA}$ , $I_B = 0.10 \text{ mA}$		0.04	0.10	V	
$V_{CE(SAT)}$	$I_C = 10 \text{ mA}$ , $I_B = 1 \text{ mA}$		0.055	0.11	V	
$V_{BE(SAT)}$	$I_C = 1 \text{ mA}$ , $I_B = 0.10 \text{ mA}$		0.8	0.95	V	
$V_{BE(SAT)}$	$I_C = 10 \text{ mA}$ , $I_B = 1 \text{ mA}$		0.9	1.0	V	
$BV_{CEO}$	$I_C = 1 \text{ mA}$	40	50		V	
$BV_{CBO}$	$I_C = 100 \mu A$	40			V	
$BV_{EBO}$	$I_E = 10 \mu A$	5	6		V	
$I_{CBO}$	$V_{CB} = 30V$			50	nA	
$I_{EBO}$	$V_{EB} = 3V$			50	nA	

# Process 71

**DC Pulse Current Gain vs Collector Current**

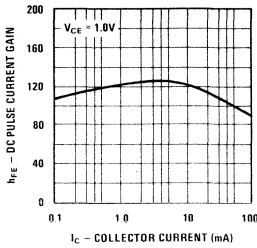

**Base-Emitter On Voltage vs Collector Current**

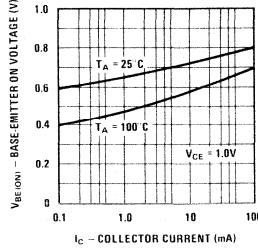

**Maximum Power Dissipation vs Ambient Temperature**

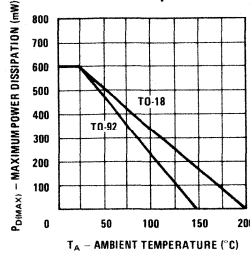

**Maximum Power Dissipation vs Ambient Temperature**

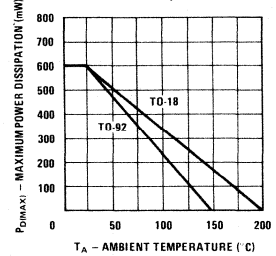

**Collector-Emitter Saturation Voltage vs Collector Current**

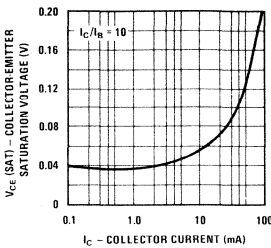

**Capacitance vs Reverse Bias Voltage**

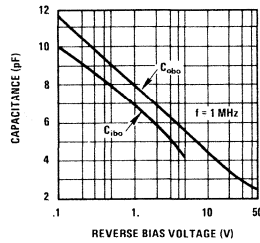

**Collector-Base Diode Reverse Current vs Temperature**

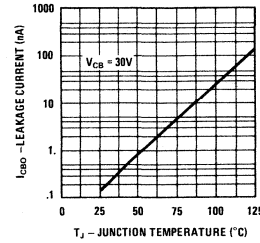

**Small Signal Current Gain vs Collector Current**

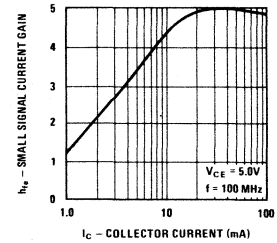

**Capacitance vs Reverse Bias Voltage**

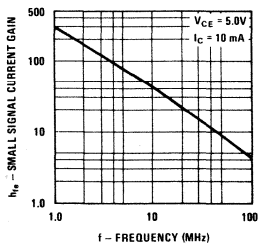

**Noise Figure vs Source Resistance**

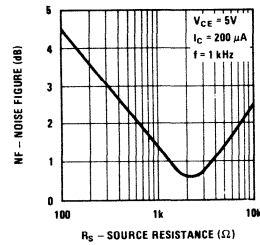

**Noise Figure vs Frequency**

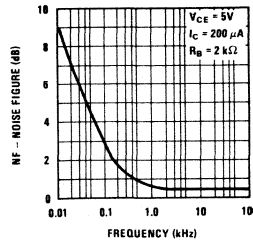

**Small Signal Input Resistance vs Collector Current**

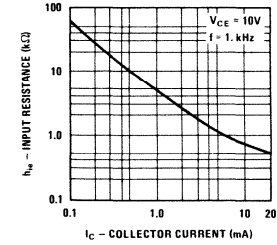

**Small Signal Output Conductance vs Collector Current**

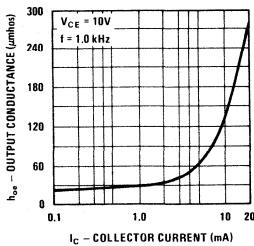

**Small Signal Current Gain vs Collector Current**

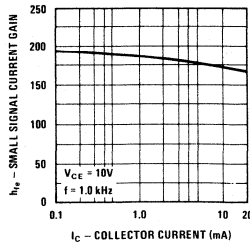

**Small Signal Voltage Feedback Ratio vs Collector Current**

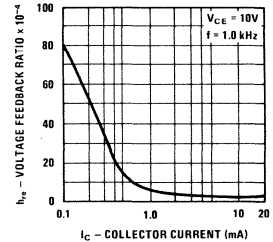

## DESCRIPTION

Process 73 is nonoverlay doubled diffused, silicon epitaxial device. Complement to Process 08.

## APPLICATION

This device was designed as a general purpose amplifier and switch for applications requiring high line voltages.

## PRINCIPAL DEVICE TYPES

TO-39	2N3634
TO-92+	TN3634

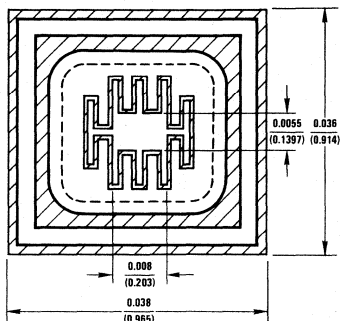

PARAMETER	TEST CONDITIONS	MIN	TYP	MAX	UNITS	NOTES
$BV_{CEO}$	$I_C = 10 \text{ mA}$	105	160	180	V	
$BV_{CBO}$	$I_C = 100 \mu\text{A}$	145		250	V	
$BV_{EBO}$	$I_E = 10 \mu\text{A}$	5	7		V	
$I_{CBO}$	$V_{CB} = 100\text{V}$			100	nA	
$I_{EBO}$	$V_{EB} = 3\text{V}$			50	nA	
$h_{FE}$	$I_C = 0.1 \text{ mA}, V_{CE} = 10\text{V}$	40	80			
$h_{FE}$	$I_C = 1 \text{ mA}, V_{CE} = 10\text{V}$	45	90			
$h_{FE}$	$I_C = 10 \text{ mA}, V_{CE} = 10\text{V}$	50	100			
$h_{FE}$	$I_C = 50 \text{ mA}, V_{CE} = 10\text{V}$	55	135	270		
$V_{CE(SAT)}$	$I_C = 50 \text{ mA}, I_B = 5 \text{ mA}$		0.15	0.3	V	
$V_{BE(SAT)}$	$I_C = 50 \text{ mA}, I_B = 5 \text{ mA}$		0.75	0.9		
$C_{OB}$	$V_{CB} = 20\text{V}$		8	10	pF	
$C_{IB}$	$V_{EB} = 1.0\text{V}$		50	75	pF	
$F_T$	$I_C = 30 \text{ mA}, V_{CE} = 30\text{V}, f = 100 \text{ MHz}$	150	225		MHz	

# Process 73

**DC Pulse Current Gain vs Collector Current**

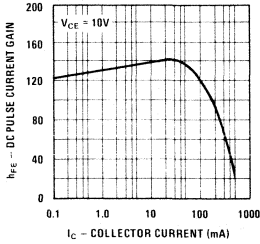

**Base-Emitter On Voltage vs Collector Current**

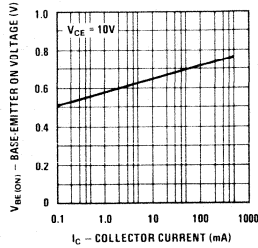

**Maximum Power Dissipation vs Ambient Temperature**

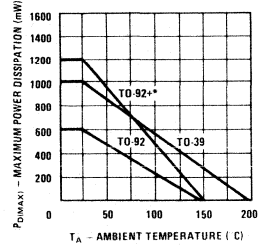

\*One square inch of copper run

**Maximum Power Dissipation vs Case Temperature**

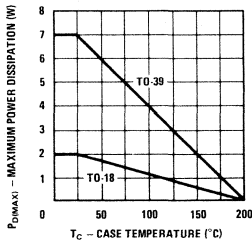

**Base-Emitter Saturation Voltage vs Collector Current**

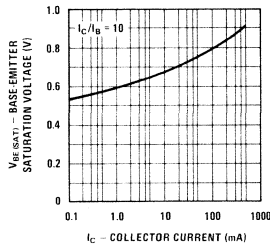

**Collector-Emitter Saturation Voltage vs Collector Current**

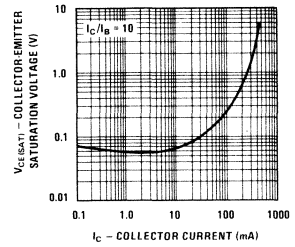

**Collector-Emitter Breakdown Voltage With Resistance Between Emitter-Base**

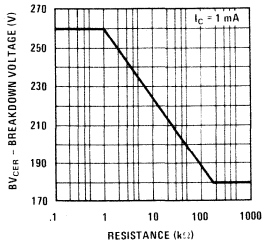

**Small Signal Current Gain vs Collector Current**

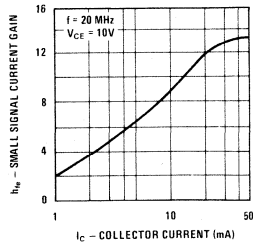

**Input and Output Capacitance vs Reverse Bias Voltage**

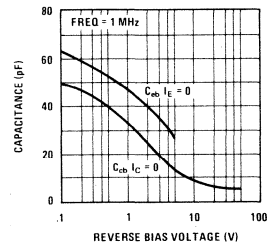

**DESCRIPTION**

Process 74 is nonoverlay double diffused, silicon epitaxial device. Complement to Process 16.

**APPLICATION**

This device was designed as a general purpose amplifier and switch for applications requiring high line voltages

**PRINCIPAL DEVICE TYPES**

TO-92      2N5401, MPSL51

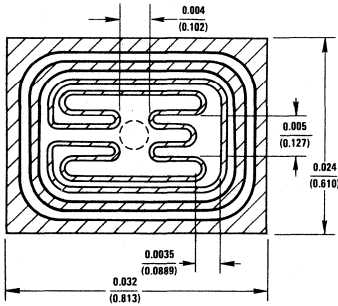

PARAMETER	TEST CONDITIONS	MIN	TYP	MAX	UNITS	NOTES
$BV_{CEO}$	$I_C = 1 \text{ mA}$	105	170	210	V	
$BV_{CBO}$	$I_C = 100 \mu\text{A}$	150		275	V	
$BV_{EBO}$	$I_E = 10 \mu\text{A}$	6				
$I_{CBO}$	$V_{CB} = 100\text{V}$			100	nA	
$I_{EBO}$	$V_{EB} = 3\text{V}$			50	nA	
$h_{FE}$	$I_C = 1 \text{ mA}, V_{CE} = 5\text{V}$	30	60			
$h_{FE}$	$I_C = 10 \text{ mA}, V_{CE} = 5\text{V}$	40	150	240		
$h_{FE}$	$I_C = 50 \text{ mA}, V_{CE} = 5\text{V}$	40	60			
$V_{CE(SAT)}$	$I_C = 50 \text{ mA}, I_B = 5 \text{ mA}$		0.18	0.25		
$V_{BE(SAT)}$	$I_C = 50 \text{ mA}, I_B = 5 \text{ mA}$		0.77	1.0		
$C_{OB}$	$V_{CB} = 10\text{V}$		8	12	pF	
$f_T$	$I_C = 10 \mu\text{A}, V_{CE} = 10\text{V}, f = 100 \text{ MHz}$	100	160	300	MHz	

# Process 74

**DC Pulse Current Gain vs Collector Current**

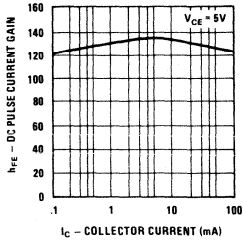

**Base-Emitter On Voltage vs Collector Current**

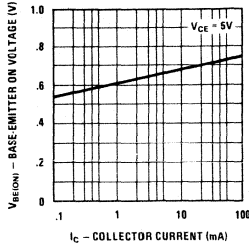

**Maximum Power Dissipation vs Ambient Temperature TO-92**

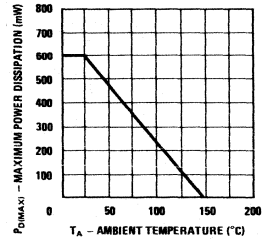

**Maximum Power Dissipation vs Case Temperature TO-92**

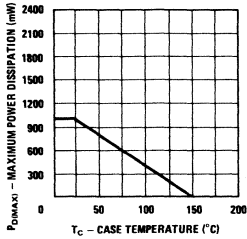

**Base-Emitter Saturation Voltage vs Collector Current**

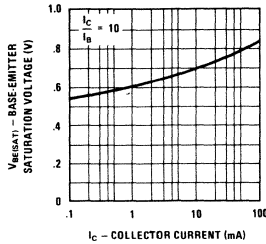

**Collector-Emitter Saturation Voltage vs Collector Current**

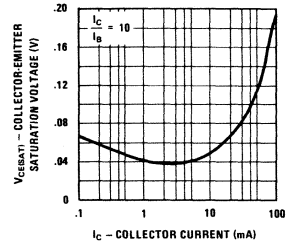

**Collector-Emitter Break-down Voltage With Resistance Between Base-Emitter**

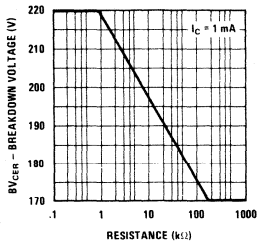

**Small Signal Current Gain vs Collector Current**

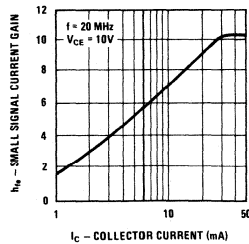

**Input and Output Capacitance vs Reverse Bias Voltage**

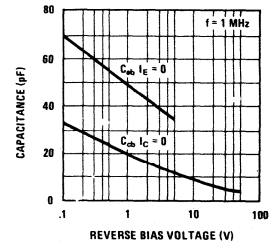

## DESCRIPTION

Process 77 is a double diffused silicon epitaxial planar device. Complement to Process 37.

## APPLICATION

This device was designed for general purpose medium power amplifier and switching circuits that require collector currents to 1A.

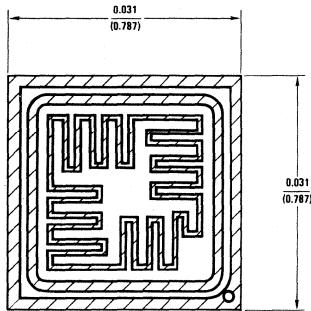

PARAMETER	TEST CONDITIONS	MIN	TYP	MAX	UNITS
$BV_{CEO}$	$I_C = 10 \text{ mA}$	25		45	V
$BV_{CBO}$	$I_C = 100 \mu\text{A}$	40			V
$BV_{EBO}$	$I_E = 100 \mu\text{A}$	5	7		V
$I_{CBO}$	$V_{CB} = BV_{CEO}$		50	500	nA
$I_{EBO}$	$V_{EB} = 5\text{V}$		0.1	100	$\mu\text{A}$
$h_{FE}$	$I_C = 500 \text{ mA}, V_{CE} = 1\text{V}$	50		250	
$V_{CE(SAT)}$	$I_C = 1\text{A}, I_B = 0.1\text{A}$		0.3	0.5	V
$V_{BE(SAT)}$	$I_C = 1\text{A}, I_B = 0.1\text{A}$		1.0	1.5	V
$f_T$	$I_C = 100 \text{ mA}, V_{CE} = 10\text{V}$		200		MHz
$C_{OBO}$	$V_{CB} = 10\text{V}$			20	pF

## PRINCIPAL DEVICE TYPES

**TO-202 (Package 35)**    **92 PLUS (Package 91)**

NSD202                    92PU51  
 NSD203                    92PU51A  
 NSDU51                    BD370A  
 NSDU51A

**TO-202 (Package 36)**    **TO-126 (Package 38)**  
 D43C1                      BD136  
 D43C2  
 D43C3  
 D43C4  
 D43C5  
 D43C6  
 NSE170

**92 PLUS (Package 90)**

92PE77A  
 BD372A

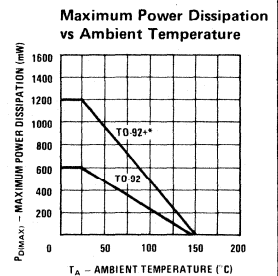
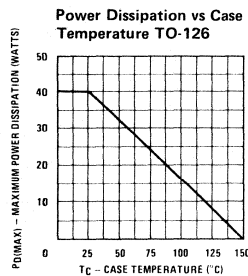

\*One square inch of copper run



**Typical Normalized Pulsed Current Gain vs Collector Current**

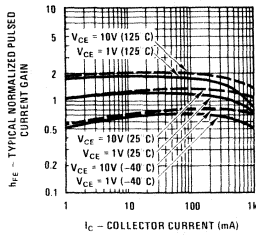

**Base-Emitter "ON" Voltage vs Collector Current**

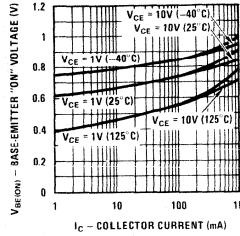

**Base-Emitter Saturation Voltage vs Collector Current**

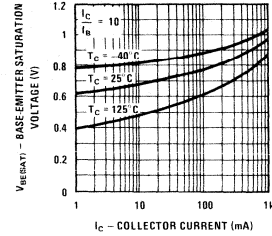

**Collector-Emitter Saturation Voltage vs Collector Current**

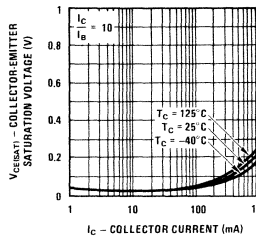

**Gain Bandwidth Product vs Collector Current**

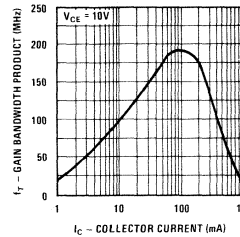

**Collector-Base Capacitance vs Collector-Base Voltage**

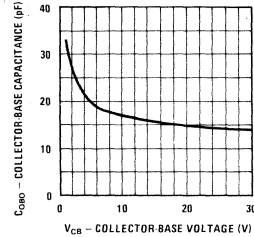

**Safe Operating Area TO-202**

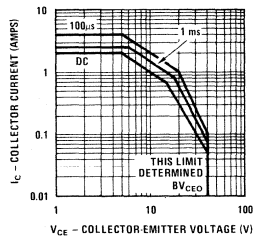

**Maximum Power Dissipation vs Ambient Temperature (TO-202)**

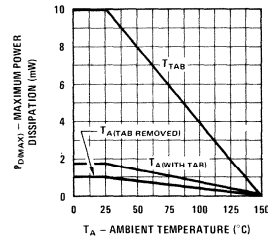

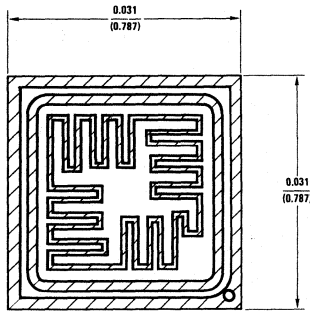

## DESCRIPTION

Process 78 is a double diffused silicon epitaxial planar device complement to Process 38.

## APPLICATION

This device was designed for general purpose medium power amplifier and switching circuits that require collector currents to 1A.

PARAMETER	TEST CONDITIONS	MIN	TYP	MAX	UNITS
$BV_{CEO}$	$I_C = 10 \text{ mA}$	45		80	V
$BV_{CBO}$	$I_C = 100\mu\text{A}$	75		110	V
$BV_{EBO}$	$I_E = 100\mu\text{A}$	5	7		V
$I_{CBO}$	$V_{CB} = BV_{CEO}$		50	500	nA
$I_{EBO}$	$V_{EB} = 5\text{V}$		0.1	100	$\mu\text{A}$
$h_{FE}$	$I_C = 100 \text{ mA}, V_{CE} = 1\text{V}$	50		250	
$V_{CE(SAT)}$	$I_C = 500 \text{ mA}, I_B = 50 \text{ mA}$		0.2	0.5	V
$V_{BE(SAT)}$	$I_C = 500 \text{ mA}, I_B = 50 \text{ mA}$		0.95	1.4	V
$f_T$	$I_C = 100 \text{ mA}, V_{CE} = 10\text{V}$	50			MHz
$C_{OBO}$	$V_{CB} = 10\text{V}$			15	pF

## PRINCIPAL DEVICE TYPES

**TO-202 (Package 35)**    **TO-126 (Package 38)**  
 NSDU55                      BD138  
 NSD6180  
 NSD6181

**TO-202 (Package 36)**  
 D43C7  
 D43C8  
 D43C9  
 NSE171

**92 PLUS (Package 90)**  
 92PE77B  
 BD372B  
 BD372C

**92 PLUS (Package 91)**  
 92PU55  
 BD370B  
 BD370C

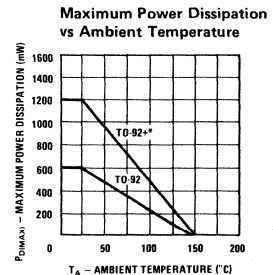
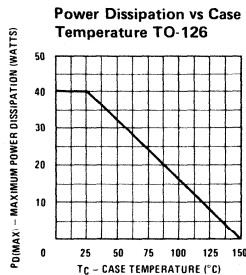

\*One square inch of copper run

# Process 78

**Typical Normalized Pulsed Current Gain vs Collector Current**

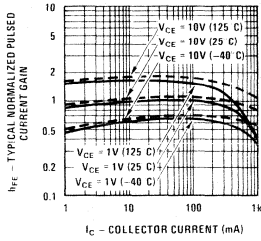

**Base-Emitter "ON" Voltage vs Collector Current**

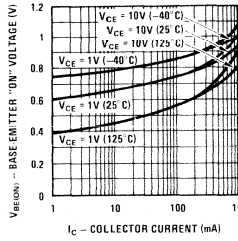

**Base-Emitter Saturation Voltage vs Collector Current**

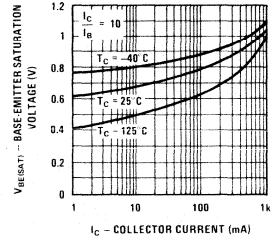

**Collector-Emitter Saturation Voltage vs Collector Current**

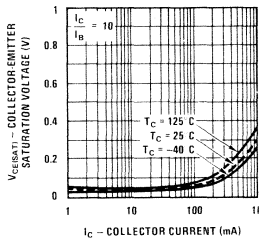

**Gain Bandwidth Product vs Collector Current**

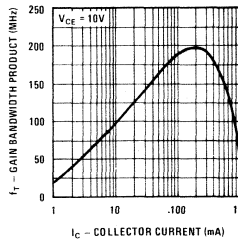

**Collector-Base Capacitance vs Collector-Base Voltage**

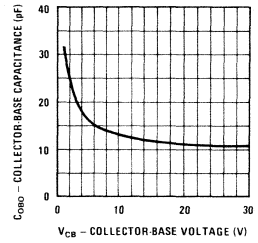

**Safe Operating Area TO-202**

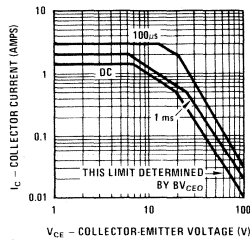

**Maximum Power Dissipation vs Ambient Temperature**

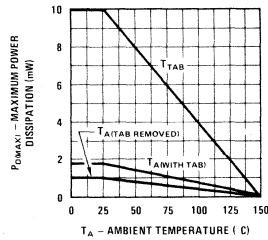

## DESCRIPTION

Process 79 is a double diffused silicon epitaxial planar device complement to Process 39.

## APPLICATION

This device was designed for general purpose medium power amplifier and switching circuits that require collector currents to 1A.

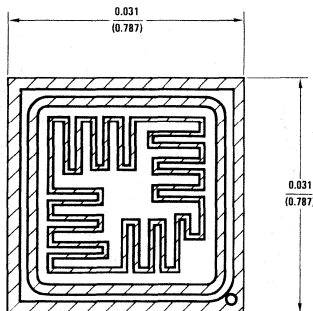

PARAMETER	TEST CONDITIONS	MIN	TYP	MAX	UNITS
$BV_{CEO}$	$I_C = 10 \text{ mA}$	80		110	V
$BV_{CBO}$	$I_C = 100 \mu\text{A}$	110		140	V
$BV_{EBO}$	$I_E = 100 \mu\text{A}$	5	7		V
$I_{CBO}$	$V_{CB} = BV_{CEO}$		50	500	nA
$I_{EBO}$	$V_{EB} = 5\text{V}$		0.1	100	$\mu\text{A}$
$h_{FE}$	$I_C = 100 \text{ mA}, V_{CE} = 1\text{V}$	25		150	
$V_{CE(SAT)}$	$I_C = 500 \text{ mA}, I_B = 50 \text{ mA}$		0.2	0.5	V
$V_{BE(SAT)}$	$I_C = 500 \text{ mA}, I_B = 50 \text{ mA}$		0.9	1.4	V
$f_T$	$I_C = 100 \text{ mA}, V_{CE} = 10\text{V}$	50	120		MHz
$C_{OBO}$	$V_{CB} = 10\text{V}$			15	pF

## PRINCIPAL DEVICE TYPES

### TO-202 (Package 35)

NSD204  
NSD205  
NSD206  
NSDU56  
NSDU57

### 92 PLUS (Package 90)

92PE77C  
BD372D

### 92 PLUS (Package 91)

92PU56  
92PU57  
BD370D

### TO-126 (Package 38)

BD140

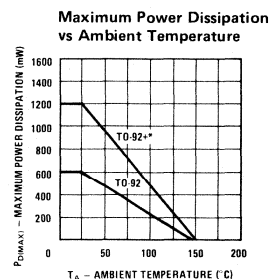
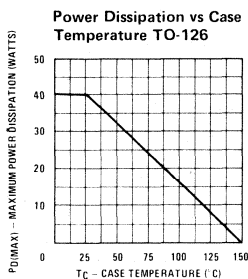

\*One square inch of copper run

**Typical Normalized Pulsed Current Gain vs Collector Current**

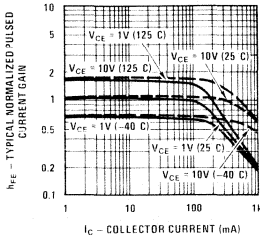

**Base-Emitter "ON" Voltage vs Collector Current**

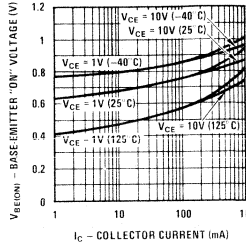

**Base-Emitter Saturation Voltage vs Collector Current**

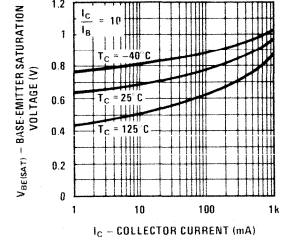

**Collector-Emitter Saturation Voltage vs Collector Current**

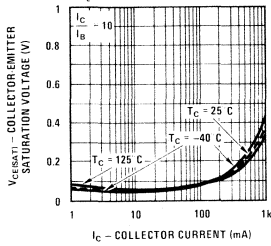

**Gain Bandwidth Product vs Collector Current**

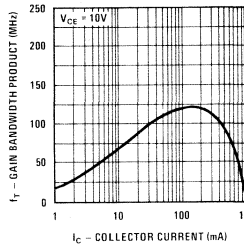

**Collector-Base Capacitance vs Collector-Base Voltage**

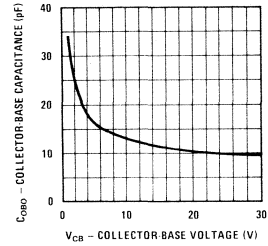

**Safe Operating Area TO-202**

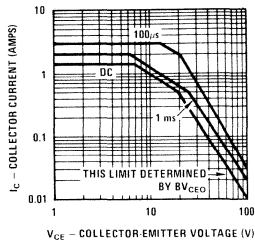

**Maximum Power Dissipation vs Ambient Temperature (TO-202)**

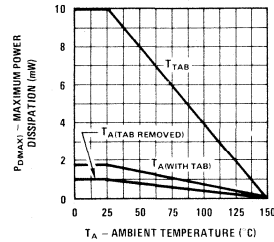





**Section 7**  
**Process**  
**Characteristics Mesa**  
**Transistors**



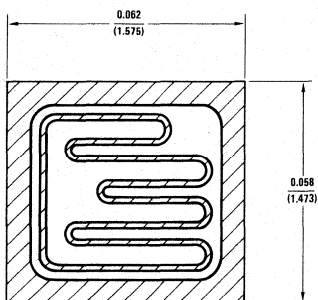

## DESCRIPTION

Process 2C/4F is a double epitaxial silicon mesa with diffused emitter.

## APPLICATION

This device was designed for general purpose power amplifier and switching circuits where a large safe operating area is required.

PARAMETER	TEST CONDITIONS	MIN	TYP	MAX	UNITS
$BV_{CEO}$	$I_C = 100 \text{ mA}$ , (Note 1)	30		100	V
$BV_{CBO}$	$I_C = 1 \text{ mA}$	60		200	V
$BV_{EBO}$	$I_E = 1 \text{ mA}$	5	8		V
$I_{CEO}$	$V_{CE} = BV_{CEO} - 10\text{V}$		10	300	$\mu\text{A}$
$I_{CBO}$	$V_{CB} = BV_{CEO}$		0.1	10	$\mu\text{A}$
$I_{EBO}$	$V_{EB} = 5\text{V}$		10	100	$\mu\text{A}$
$h_{FE}$	$I_C = 1.0\text{A}$ , $V_{CE} = 1\text{V}$ , (Note 1)	15		200	
$V_{CE(SAT)}$	$I_C = 2.0\text{A}$ , $I_B = 0.3\text{A}$ , (Note 1)			0.5	V
$V_{BE(ON)}$	$I_C = 2.0\text{A}$ , $V_{CE} = 2.0\text{V}$ , (Note 1)			1.0	V
SOA	TO-220, $V_{CE} = 25\text{V}$ , $t = 1 \text{ sec}$	1.6			A
SOA	TO-126, $V_{CE} = 33.3\text{V}$ , $t = 1 \text{ sec}$	0.9			A
SOA	TO-202, $V_{CE} = 30\text{V}$ , $t = 1 \text{ sec}$	0.4			A
$f_T$	$I_C = 0.5\text{A}$ , $V_{CE} = 2\text{V}$	4			MHz
$t_d$	$I_C = 1\text{A}$ , $I_{B1} = I_{B2} = 0.1\text{A}$ , $V_{CC} = 40\text{V}$		0.05		$\mu\text{s}$
$t_r$	$I_C = 1\text{A}$ , $I_{B1} = I_{B2} = 0.1\text{A}$ , $V_{CC} = 40\text{V}$		0.25		$\mu\text{s}$
$t_s$	$I_C = 1\text{A}$ , $I_{B1} = I_{B2} = 0.1\text{A}$ , $V_{CC} = 40\text{V}$		0.75		$\mu\text{s}$
$t_f$	$I_C = 1\text{A}$ , $I_{B1} = I_{B2} = 0.1\text{A}$ , $V_{CC} = 40\text{V}$		0.25		$\mu\text{s}$
$P_{D(MAX)}$	TO-220	40			W
	TO-126	30			W
	TO-202	12.5			W
$\theta_{jc}$	TO-220			3.125	$^{\circ}\text{C/W}$
	TO-126			4.167	$^{\circ}\text{C/W}$
	TO-202			10.0	$^{\circ}\text{C/W}$

Note 1: Pulsed measurement = 300 $\mu\text{s}$  pulse width.

## PRINCIPAL DEVICE TYPES

### TO-220 (Package 37)

DC44C1	NSP520	TIP29B
DC44C2	NSP521	TIP29C
DC44C4	NSP4921	TIP31
DC44C5	NSP4922	TIP31A
DC44C7	NSP4923	TIP31B
DC44C8	TIP29	TIP31C
DC44C10	TIP29A	TIP61

### TO-126 (Package 38)

TIP61A	2N4921
TIP61B	2N4922
TIP61C	2N4923
MJE520	
MJE521	



# Process 2C/4F

**Typical Normalized Pulsed Current Gain vs Collector Current**

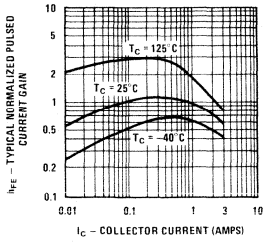

**Base-Emitter "ON" Voltage vs Collector Current**

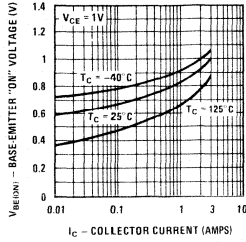

**Base-Emitter Saturation Voltage vs Collector Current**

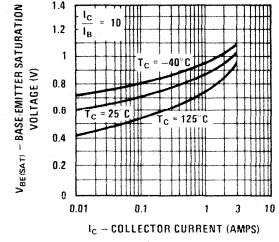

**Collector-Emitter Saturation Voltage vs Collector Current**

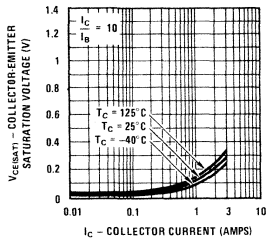

**Gain Bandwidth Product vs Collector Current**

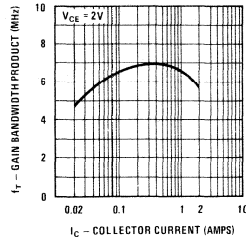

**Collector-Base Capacitance vs Collector-Base Voltage**

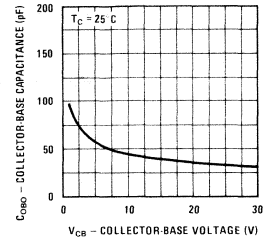

**Safe Operating Area TO-220**

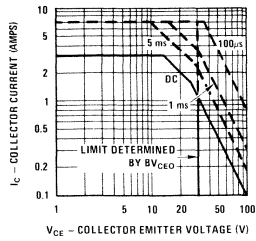

**Safe Operating Area TO-126**

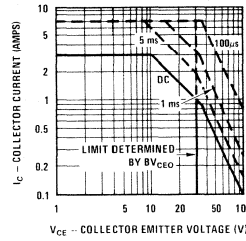

**Safe Operating Area TO-202**

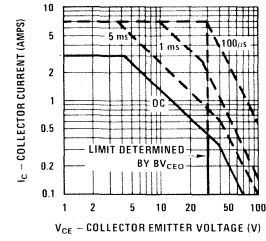

**Maximum Power Dissipation vs Case Temperature**

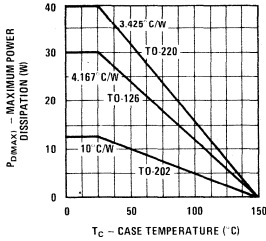

**Switching Circuit**

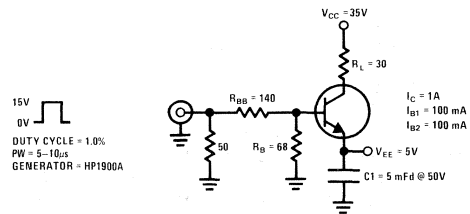



# Process 2E/4E NPN Epitaxial Power

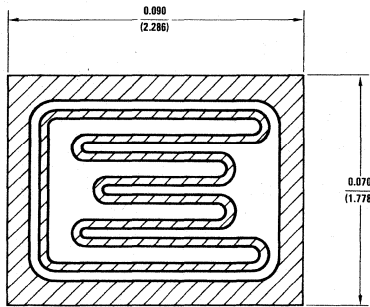

## DESCRIPTION

Process 2E/4E is a double epitaxial silicon mesa with diffused emitter.

## APPLICATION

This device was designed for general purpose power amplifier and switching circuits where a large safe operation area is required.

PARAMETER	TEST CONDITIONS	MIN	TYP	MAX	UNITS
$BV_{CEO}$	$I_C = 100 \text{ mA}$ , (Note 1)	30	60	100	V
$BV_{CBO}$	$I_C = 1 \text{ mA}$	50		200	V
$BV_{EBO}$	$I_E = 1 \text{ mA}$	5	8		V
$I_{CEO}$	$V_{CE} = BV_{CEO} - 10V$		50	300	$\mu\text{A}$
$I_{CBO}$	$V_{CB} = BV_{CEO}$		10	100	$\mu\text{A}$
$I_{EBO}$	$V_{EB} = 5V$		50	1000	$\mu\text{A}$
$h_{FE}$	$I_C = 1.5A$ , $V_{CE} = 20V$ , (Note 1)	20		200	
$V_{CE(SAT)}$	$I_C = 4.0A$ , $I_B = 0.6A$ , (Note 1)			0.6	V
$V_{BE(ON)}$	$I_C = 4.0A$ , $V_{CE} = 2.0V$ , (Note 1)			1.3	V
SOA	TO-220, $V_{CE} = 33.3V$ , $t = 1 \text{ sec}$	1.5			A
SOA	TO-126, $V_{CE} = 33.3V$ , $t = 1 \text{ sec}$	1.2			A
SOA	TO-202, $V_{CE} = 30V$ , $t = 1 \text{ sec}$	0.5			A
$f_T$	$I_C = 0.5A$ , $V_{CE} = 2V$ , $f = 1 \text{ MHz}$	4			MHz
$t_d$	$I_C = 1.0A$ , $I_{B1} = 0.1A$ , $I_{B2} = 0.1A$ , $V_{CC} = 30V$		0.10		$\mu\text{s}$
$t_r$	$I_C = 1.0A$ , $I_{B1} = 0.1A$ , $I_{B2} = 0.1A$ , $V_{CC} = 30V$		0.25		$\mu\text{s}$
$t_s$	$I_C = 1.0A$ , $I_{B1} = 0.1A$ , $I_{B2} = 0.1A$ , $V_{CC} = 30V$		0.35		$\mu\text{s}$
$t_f$	$I_C = 1.0A$ , $I_{B1} = 0.1A$ , $I_{B2} = 0.1A$ , $V_{CC} = 30V$		0.23		$\mu\text{s}$
$P_{D(MAX)}$	TO-220	50			W
	TO-126	40			W
	TO-202	15			W
$\theta_{jc}$	TO-220			2.5	$^{\circ}\text{C/W}$
	TO-126			3.125	$^{\circ}\text{C/W}$
	TO-202			8.33	$^{\circ}\text{C/W}$

Note 1: Pulsed measurement = 300 $\mu\text{s}$  pulse width

## PRINCIPAL DEVICE TYPES

### TO-220 (Package 37)

2N5293	2N5298	2N6130	2N6291	D44C9	NSP41B	2N5190
2N5294	2N6121	2N6131	2N6292	D44C11	NSP41C	2N5191
2N5295	2N6122	2N6288	2N6293	D44C12	NSP5190	2N5192
2N5296	2N6123	2N6289	D44C3	NSP41	NSP5192	
2N5297	2N6129	2N6290	D44C6	NSP41A	NSP5193	

### TO-126 (Package 38)

# Process 2E/4E

**Typical Normalized Pulsed Current Gain vs Collector Current**

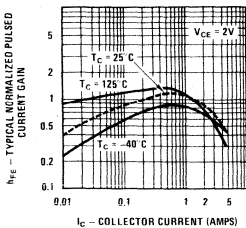

**Base-Emitter "ON" Voltage vs Collector Current**

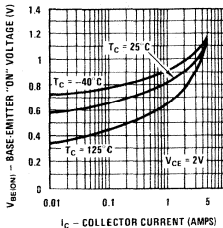

**Base-Emitter Saturation Voltage vs Collector Current**

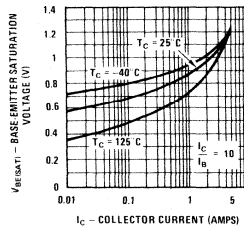

**Collector-Emitter Saturation Voltage vs Collector Current**

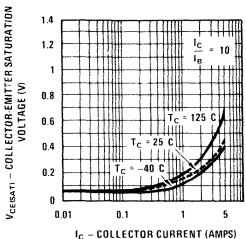

**Gain Bandwidth Product vs Collector Current**

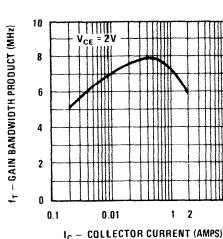

**Typical Collector Capacitance vs Collector-Base Voltage**

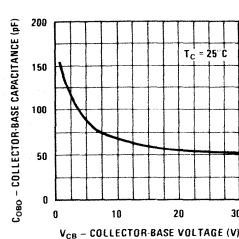

**Safe Operating Area TO-220**

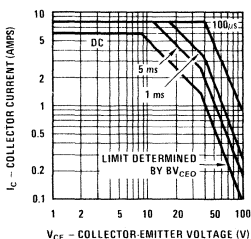

**Safe Operating Area TO-126**

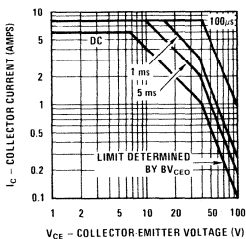

**Safe Operating Area TO-202**

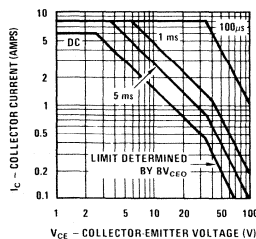

**Maximum Power Dissipation vs Case Temperature**

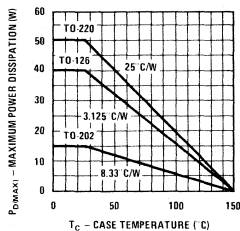

**Switching Circuit**

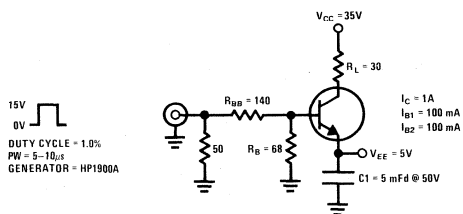

## DESCRIPTION

Process 2J/4J is a double epitaxial silicon mesa device. Complement to Process 3J/5J.

## APPLICATION

This device was designed for use in driver and output stages of complementary audio amplifier circuits. It is also well suited for solenoid driver applications.

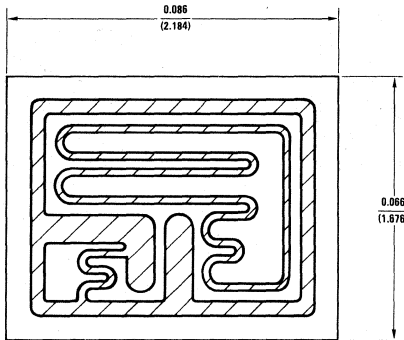

PARAMETER	TEST CONDITIONS	MIN	TYP	MAX	UNITS
$BV_{CEO}$	$I_C = 100 \text{ mA}$	30		100	V
$BV_{CBO}$	$I_C = 100 \mu\text{A}$	50		120	V
$BV_{EBO}$	$I_E = 2 \text{ mA}$	5			V
$I_{CEO}$	$V_{CE} = 1/2 BV_{CEO}$			0.5	mA
$I_{CBO}$	$V_{CB} = BV_{CEO}$			200	$\mu\text{A}$
$I_{EBO}$	$V_{EB} = 5\text{V}$			2.0	mA
$h_{FE}$	$I_C = 2\text{A}, V_{CE} = 3\text{V}$	500		15,000	
$V_{CE(SAT)}$	$I_C = 5\text{A}, I_B = 2.0 \text{ mA}$			3.0	V
$V_{BE(ON)}$	$I_C = 5\text{A}, V_{CE} = 3\text{V}$			2.5	V
$C_{OBO}$	$V_{CB} = 10\text{V}$		30		pF
$ h_{FE} $	$I_C = 1\text{A}, V_{CE} = 3\text{V}, f = 1 \text{ MHz}$		9		MHz
$t_{ON}$	$I_C = 6\text{A}, V_{CE} = 30\text{V}, (\text{Figure 1})$		1.25		$\mu\text{s}$
$t_{OFF}$	$I_C = 6\text{A}, V_{CE} = 30\text{V}, (\text{Figure 1})$		2.75		$\mu\text{s}$
SOA	TO-220, $V_{CE} = 33\text{V}, t = 1 \text{ sec}$	1.5			A
SOA	TO-126, $V_{CE} = 33\text{V}, t = 1 \text{ sec}$	1.2			A
$P_{D(MAX)}$	TO-220	50			W
$P_{D(MAX)}$	TO-126	40			W
$\theta_{jc}$	TO-220			2.5	$^{\circ}\text{C/W}$
$\theta_{jc}$	TO-126			3.125	$^{\circ}\text{C/W}$

## PRINCIPAL DEVICE TYPES

<b>TO-220 (Package 37)</b>	<b>TO-126 (Package 38)</b>
2N6386 NSP2101	2N6037 MJE802
TIP110 NSP2102	2N6038 MJE803
TIP111 NSP2103	2N6039
TIP112	MJE800
NSP2100	MJE801

# Process 2J/4J

**Typical Normalized Pulsed Current Gain vs Collector Current**

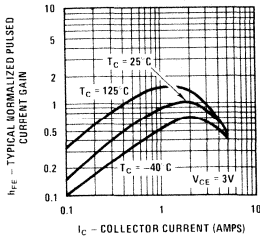

**Base-Emitter "ON" Voltage vs Collector Current**

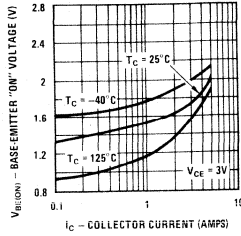

**Base-Emitter Saturation Voltage vs Collector Current**

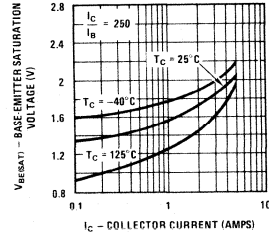

**Collector-Emitter Saturation Voltage vs Collector Current**

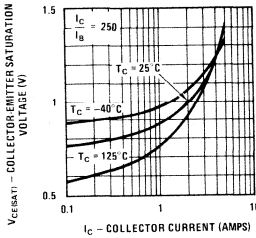

**Safe Operating Area TO-126**

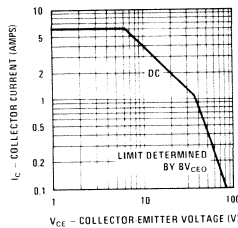

**Safe Operating Area TO-220**

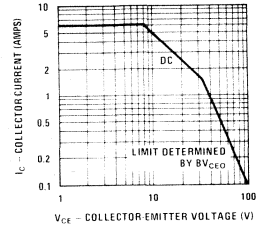

**Maximum Power Dissipation vs Case Temperature**

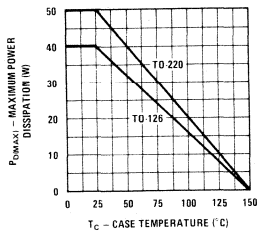

**Switching Times vs Collector Current**

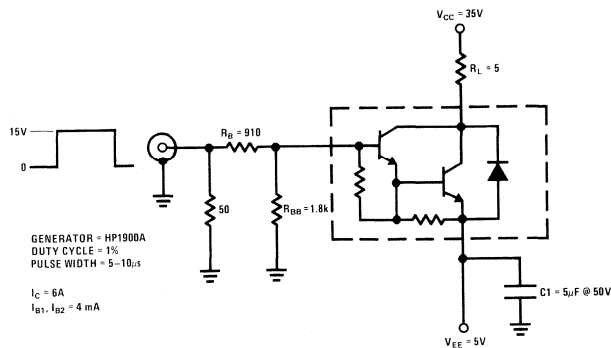
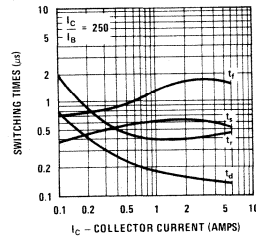

FIGURE 1

## DESCRIPTION

Process 3C/5F is a double epitaxial silicon mesa with diffused emitter.

## APPLICATION

This device was designed for general purpose power amplifier and switching circuits where a large safe operating area is required.

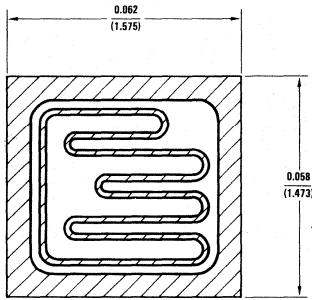

PARAMETER	TEST CONDITIONS	MIN	TYP	MAX	UNITS
$BV_{CEO}$	$I_C = 100 \text{ mA}$	30		100	V
$BV_{CBO}$	$I_C = 1 \text{ mA}$	50		150	V
$BV_{EBO}$	$I_E = 1 \text{ mA}$	5	6.5		V
$I_{CEO}$	$V_{CE} = BV_{CEO} - 10V$		10	300	$\mu A$
$I_{CBO}$	$V_{CB} = BV_{CEO}$		0.1	10	$\mu A$
$I_{EBO}$	$V_{EB} = 5V$		10	100	$\mu A$
$h_{FE}$	$I_C = 1.0A, V_{CE} = 1.0V$	10		120	
$V_{CE(SAT)}$	$I_C = 2.0A, I_B = 0.3A$			0.5	V
$V_{BE(ON)}$	$I_C = 2.0A, V_{CE} = 2.0V$			1.1	V
SOA	TO-220, $V_{CE} = 25V, t = 1 \text{ sec}$	1.6			A
SOA	TO-126, $V_{CE} = 33.3V, t = 1 \text{ sec}$	0.9			A
SOA	TO-202, $V_{CE} = 33.3V, t = 1 \text{ sec}$	0.375			A
$f_T$	$I_C = 0.5A, V_{CE} = 2V$	4			MHz
$t_d$			0.03		$\mu s$
$t_r$	$I_C = 1A, I_{B1} = I_{B2} = 0.1A$		0.20		$\mu s$
$t_s$	$V_{CC} = 40V$		0.26		$\mu s$
$t_f$			0.20		$\mu s$
$P_D$	TO-220			40	W
	TO-126			30	W
	TO-202			12.5	W
$\theta_{jc}$	TO-220			3.125	$^{\circ}C/W$
	TO-126			4.167	$^{\circ}C/W$
	TO-202			10.0	$^{\circ}C/W$

Note 1: Pulsed measurement = 300 $\mu s$  pulse width.

## PRINCIPAL DEVICE TYPES

### TO-220 (Package 37)

### TO-126 (Package 38)

D45C1	D45C7	NSP370	TIP30	TIP32	TIP62	2N4918
D45C2	D45C8	NSP4918	TIP30A	TIP32A	TIP62A	2N4919
D45C4	D45C10	NSP4919	TIP30B	TIP32B	TIP62B	2N4920
D45C5	D45C11	NSP4920	TIP30C	TIP32C	TIP62C	MJE370

# Process 3C/5F

**Typical Normalized Pulsed Current Gain vs Collector Current**

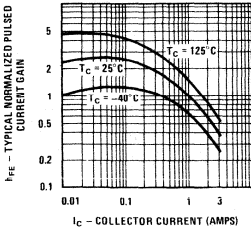

**Base-Emitter "ON" Voltage vs Collector Current**

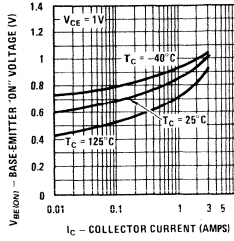

**Base-Emitter Saturation Voltage vs Collector Current**

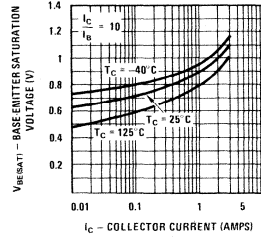

**Collector-Emitter Saturation Voltage vs Collector Current**

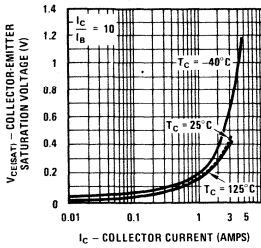

**Gain Bandwidth Product vs Collector Current**

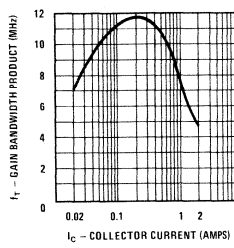

**Typical Collector Capacitance vs Collector-Base Voltage**

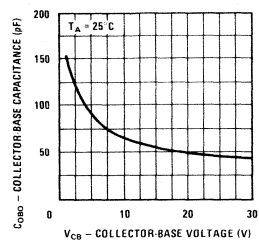

**Safe Operating Area TO-220**

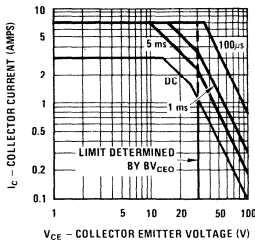

**Safe Operating Area TO-126**

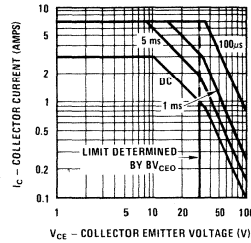

**Safe Operating Area TO-202**

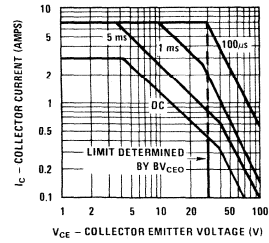

**Maximum Power Dissipation vs Case Temperature**

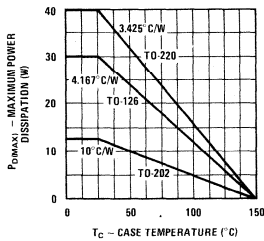

**Switching Circuit**

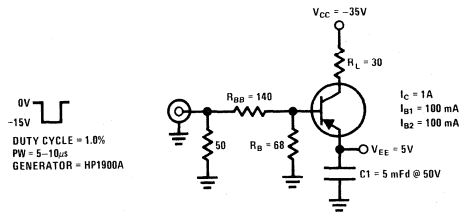



# Process 3E/5E PNP Epitaxial Power

## DESCRIPTION

Process 3E/5E is a double epitaxial silicon mesa with diffused emitter.

## APPLICATION

This device was designed for general purpose power amplifier and switching circuits where a large safe operation area is required.

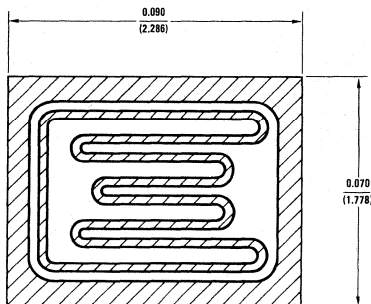

PARAMETER	TEST CONDITIONS	MIN	TYP	MAX	UNITS
$V_{CE0}$	$I_C = 100 \text{ mA}$ , (Note 1)	30	60	100	V
$V_{CBO}$	$I_C = 1 \text{ mA}$	40		150	V
$V_{EBO}$	$I_E = 1 \text{ mA}$	5	8		V
$I_{CE0}$	$V_{CE} = V_{CE0}$		50	300	$\mu\text{A}$
$I_{CBO}$	$V_{CB} = V_{CE0}$		10	100	$\mu\text{A}$
$I_{EBO}$	$V_{EB} = 5\text{V}$		50	1000	$\mu\text{A}$
$h_{FE}$	$I_C = 1.5\text{A}$ , $V_{CE} = 2.0\text{V}$ , (Note 1)	20		170	
$V_{CE(SAT)}$	$I_C = 4.0\text{A}$ , $I_B = 0.6\text{A}$ , (Note 1)			0.65	V
$V_{BE(ON)}$	$I_C = 4.0\text{A}$ , $V_{CE} = 2.0\text{V}$ , (Note 1)			1.3	V
SOA	TO-220, $V_{CE} = 33.3\text{V}$ , $t = 1 \text{ sec}$	1.5			A
SOA	TO-126, $V_{CE} = 33.3\text{V}$ , $t = 1 \text{ sec}$	1.2			A
SOA	TO-202, $V_{CE} = 33.3\text{V}$ , $t = 1 \text{ sec}$	0.45			A
$f_t$	$I_C = 0.5\text{A}$ , $V_{CE} = 2\text{V}$ , $f = 1 \text{ MHz}$	4			MHz
$t_d$	$I_C = 1.0\text{A}$ , $I_{B1} = 0.1\text{A}$ , $I_{B2} = 0.1\text{A}$ , $V_{CE} = 30\text{V}$		0.10		$\mu\text{s}$
$t_r$	$I_C = 1.0\text{A}$ , $I_{B1} = 0.1\text{A}$ , $I_{B2} = 0.1\text{A}$ , $V_{CE} = 30\text{V}$		0.25		$\mu\text{s}$
$t_s$	$I_C = 1.0\text{A}$ , $I_{B1} = 0.1\text{A}$ , $I_{B2} = 0.1\text{A}$ , $V_{CE} = 30\text{V}$		0.40		$\mu\text{s}$
$t_f$	$I_C = 1.0\text{A}$ , $I_{B1} = 0.1\text{A}$ , $I_{B2} = 0.1\text{A}$ , $V_{CE} = 30\text{V}$		0.23		$\mu\text{s}$
$P_D(\text{MAX})$	TO-220			50	W
	TO-126			40	W
	TO-202			15	W
$\theta_{jc}$	TO-220			2.5	$^{\circ}\text{C/W}$
	TO-126			3.125	$^{\circ}\text{C/W}$
	TO-202			8.33	$^{\circ}\text{C/W}$

Note 1: Pulsed measurement = 300 $\mu\text{s}$  pulse width.

## PRINCIPAL DEVICE TYPES

### TO-220 (Package 37)

2N6106	2N6124	D45C3	NSP42B	2N5193
2N6107	2N6125	D45C6	NSP42C	2N5194
2N6108	2N6126	D45C9	NSP371	2N5195
2N6109	2N6132	D45C12	NSP5193	MJE371
2N6110	2N6133	NSP42	NSP5194	
2N6111	2N6134	NSP42A	NSP5195	

### TO-126 (Package 38)



# Process 3E/5E

**Typical Normalized Pulsed Current Gain vs Collector Current**

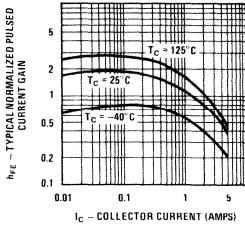

**Base-Emitter "ON" Voltage vs Collector Current**

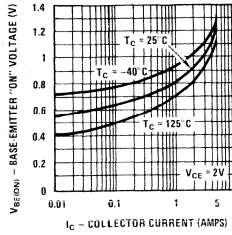

**Base-Emitter Saturation Voltage vs Collector Current**

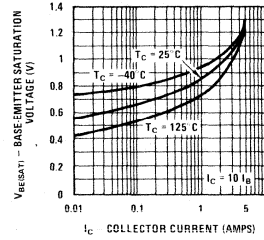

**Collector-Emitter Saturation Voltage vs Collector Current**

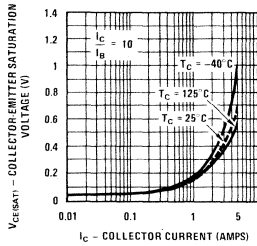

**Gain Bandwidth Product vs Collector Current**

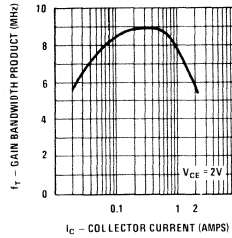

**Collector-Base Capacitance vs Collector-Base Voltage**

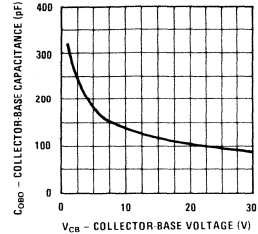

**Safe Operating Area TO-220**

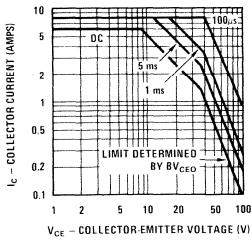

**Safe Operating Area TO-126**

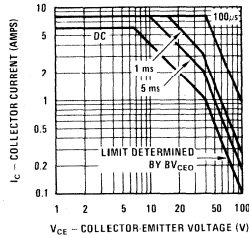

**Safe Operating Area TO-202**

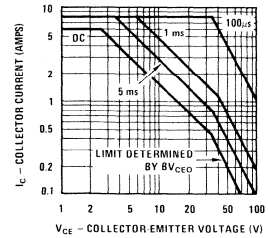

**Maximum Power Dissipation vs Case Temperature**

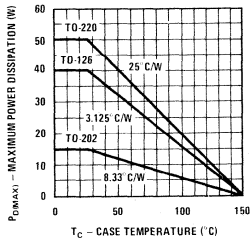

**Switching Circuit**

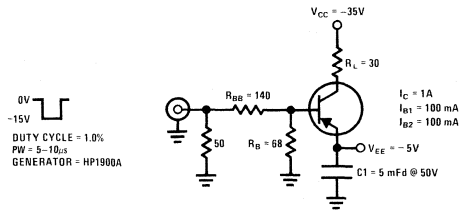



## Process 3J/5J PNP Power Darlington

### DESCRIPTION

Process 3J/5J is a double epitaxial silicon mesa device. Complement to Process 2J/4J.

### APPLICATION

This device was designed for use in driver and output stages of complementary audio amplifier circuits. It is also well suited for solenoid driver applications.

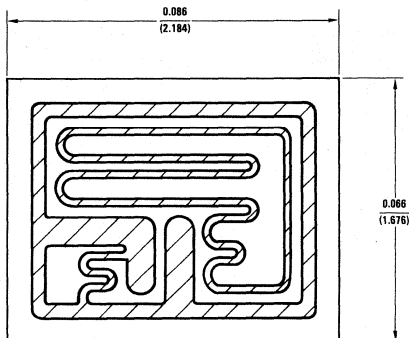

PARAMETER	TEST CONDITIONS	MIN	TYP	MAX	UNITS
$BV_{CEO}$	$I_C = 100 \text{ mA}$	30		100	V
$BV_{CBO}$	$I_C = 100\mu\text{A}$	50		120	V
$BV_{EBO}$	$I_E = 2 \text{ mA}$	5			V
$I_{CEO}$	$V_{CE} = 1/2 BV_{CEO}$			0.5	mA
$I_{CBO}$	$V_{CB} = BV_{CEO}$			200	$\mu\text{A}$
$I_{EBO}$	$V_{EB} = 5\text{V}$			2.0	mA
$h_{FE}$	$I_C = 2\text{A}, V_{CE} = 3\text{V}$	500			
$V_{CE(SAT)}$	$I_C = 5\text{A}, I_B = 2.0 \text{ mA}$			3.3	V
$V_{BE(ON)}$	$I_C = 5\text{A}, V_{CE} = 3\text{V}$			2.8	V
$C_{OBO}$	$V_{CB} = 10\text{V}$		35		pF
$ h_{FE} $	$I_C = 1\text{A}, V_{CE} = 3\text{V}, f = 1 \text{ MHz}$		4		
$t_{ON}$	$I_C = 6\text{A}, V_{CE} = 30\text{V}, (\text{Figure 1})$		2.0		
$t_{OFF}$	$I_C = 6\text{A}, V_{CE} = 30\text{V}, (\text{Figure 1})$		2.6		
$P_{D(MAX)}$	TO-220	50			W
$P_{D(MAX)}$	TO-126	40			W
$\theta_{jc}$	TO-220			2.5	$^{\circ}\text{C/W}$
$\theta_{jc}$	TO-126			3.125	$^{\circ}\text{C/W}$

### PRINCIPAL DEVICE TYPES

<b>TO-126 (Package 38)</b>	<b>TO-220 (Package 37)</b>
2N6034	TIP115
2N6035	TIP116
2N6036	TIP117
MJE700	NSP2090
MJE701	NSP2091
MJE702	NSP2092
MJE703	NSP2093

Process 3J/5J

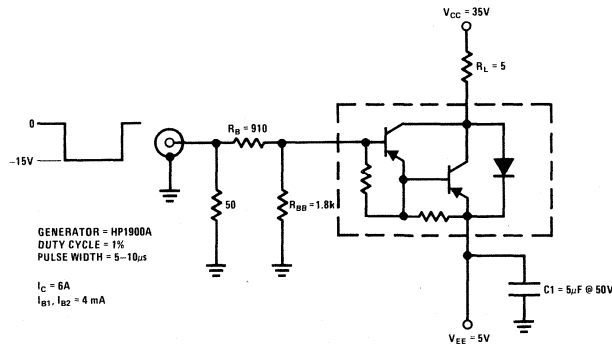
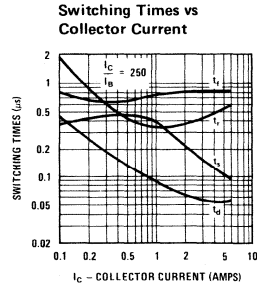
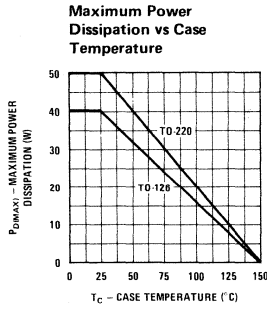
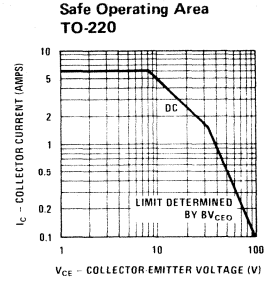
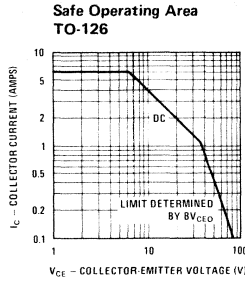
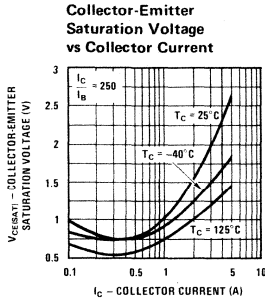
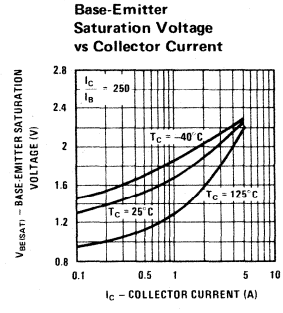
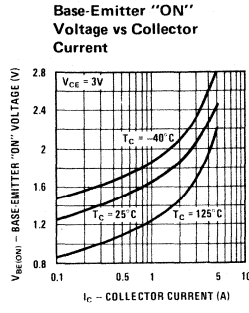
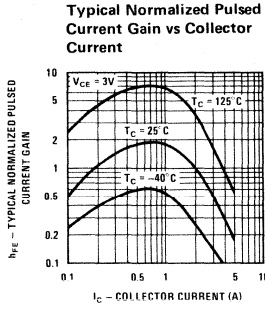
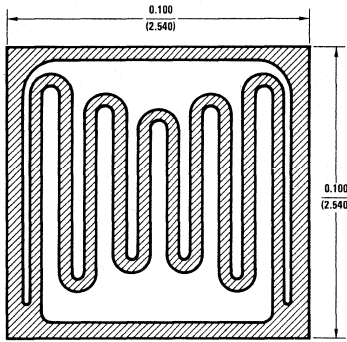

Figure 1.



## DESCRIPTION

Process 4A is a double epitaxial silicon NPN mesa device with diffused emitter.

## APPLICATION

This device was designed for general purpose power amplifier and switching circuits where a large safe operating area is required.

PARAMETER	TEST CONDITIONS	MIN	TYP	MAX	UNITS
$BV_{CEO}$	$I_C = 200 \text{ mA}$ , (Note 1)	40		100	V
$BV_{CBO}$	$I_C = 1 \text{ mA}$	60			V
$BV_{EBO}$	$I_E = 0.5 \text{ mA}$	5	7		V
$I_{CEO}$	$V_{CE} = BV_{CEO} - 10V$		10	200	$\mu\text{A}$
$I_{CBO}$	$V_{CB} = BV_{CEO} + 20V$		1	20	$\mu\text{A}$
$I_{EBO}$	$V_{EB} = 5V$		1	500	$\mu\text{A}$
$h_{FE}$	$I_C = 2.5 \text{ A}$ , $V_{CE} = 2V$	20		160	
$V_{CE(SAT)}$	$I_C = 4 \text{ A}$ , $I_B = 0.4 \text{ A}$		0.4	0.6	V
$V_{BE(ON)}$	$I_C = 5 \text{ A}$ , $V_{CE} = 2V$		1.1	1.3	V
SOA	TO-3, $I_C = 3 \text{ A}$ , $t = 1 \text{ sec}$	30			V
SOA	TO-220, $I_C = 2 \text{ A}$ , $t = 1 \text{ sec}$	30			V
$f_t$	$I_C = 0.5 \text{ A}$ , $V_{CE} = 5V$ , $f = 1 \text{ MHz}$	2	3		
$t_d$	$I_C = 5 \text{ A}$ , $I_{B1} = I_{B2} = 0.5 \text{ A}$ $V_{CC} = 40V$		0.07		$\mu\text{s}$
$t_r$	$I_C = 5 \text{ A}$ , $I_{B1} = I_{B2} = 0.5 \text{ A}$ , $V_{CC} = 40V$		0.8		$\mu\text{s}$
$t_s$	$I_C = 5 \text{ A}$ , $I_{B1} = I_{B2} = 0.5 \text{ A}$ , $V_{CC} = 40V$		0.4		$\mu\text{s}$
$t_f$	$I_C = 5 \text{ A}$ , $I_{B1} = I_{B2} = 0.5 \text{ A}$ , $V_{CC} = 40V$		0.5		$\mu\text{s}$
$P_{D(MAX)}$	TO-3	115			W
$P_{D(MAX)}$	TO-220	60			W
$\theta_{jc}$	TO-3			1.52	$^{\circ}\text{C/W}$
$\theta_{jc}$	TO 220			2.08	$^{\circ}\text{C/W}$

Note 1: Pulsed measurement = 300  $\mu\text{s}$  pulse width.

## PRINCIPAL DEVICE TYPES

### TO-220 (Package 37)

NSP5977	NSP2021	2N6102, 2N6103	D44H1
NSP5978	NSP205	2N6100, 2N6101	D44H2
NSP5979	NSP3055	2N6486	D44H4
NSP2020	2N6098, 2N6099	2N6487	D44H5

### TO-3 (Package 98)

NSP2480	2N3055	2N5067	MJ2801
NSP2481	2N4913	2N5068	
NSP2482	2N4914	2N5069	
NSP2483	2N4915	2N6569	

Process 4A

Typical Normalized Pulsed Current Gain vs Collector Current

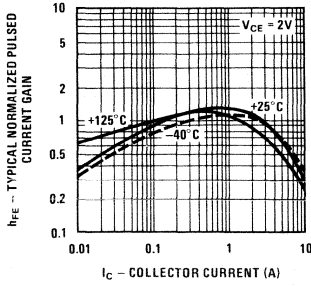

Collector-Emitter Saturation Voltage vs Collector Current

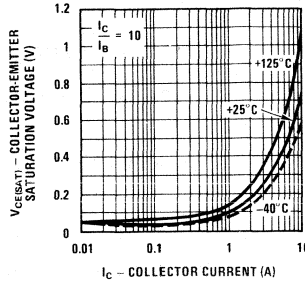

Base-Emitter Saturation Voltage vs Collector Current

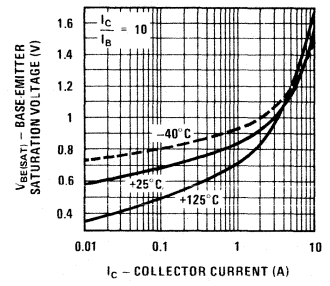

Base-Emitter "ON" Voltage vs Collector Current

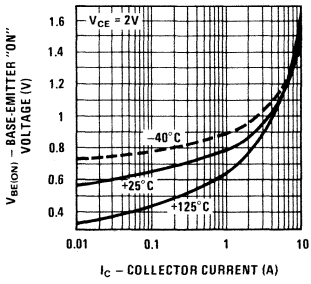

Gain Bandwidth Product vs Collector Current

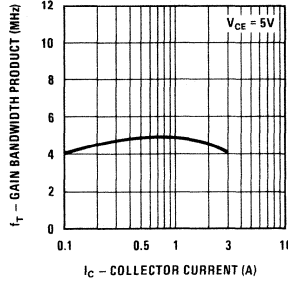

Junction Capacitance vs Reverse Bias Voltage

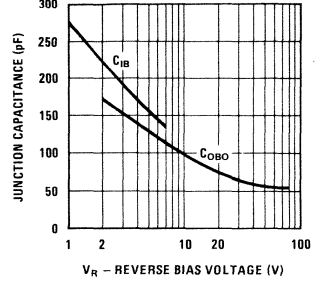

Safe Operating Area TO-3

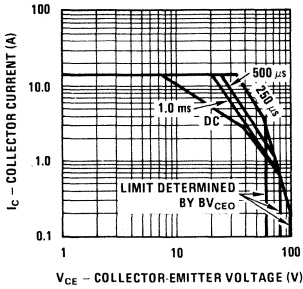

Safe Operating Area TO-220

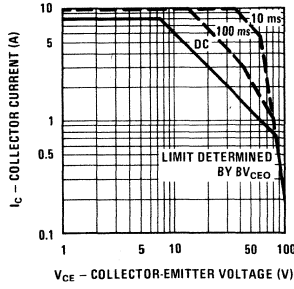

Maximum Power Dissipation vs Case Temperature

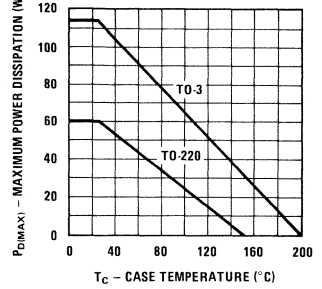

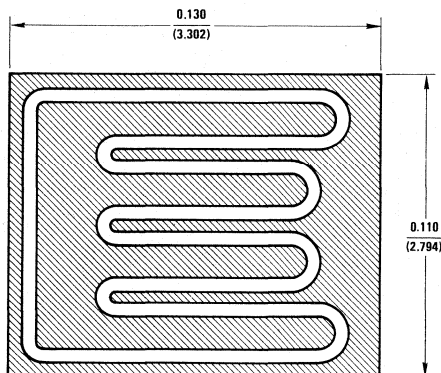
**DESCRIPTION**

Process 4B is a double epitaxial silicon mesa transistor with diffused emitter.

**APPLICATION**

This device was designed for general purpose amplifier and switching circuits where a large safe operating area is required.

PARAMETER	CONDITIONS	MIN	TYP	MAX	UNITS
BV <sub>CEO</sub>	I <sub>C</sub> = 200 mA	60	80	150	V
BV <sub>CBO</sub>	I <sub>C</sub> = 500 $\mu$ A	60			V
BV <sub>EBO</sub>	I <sub>E</sub> = 100 $\mu$ A	5	7		V
I <sub>CEO</sub>	V <sub>CE</sub> = 30V			1	mA
I <sub>CEX</sub>	V <sub>CE</sub> = 60V, V <sub>BE</sub> = -1.5V			0.5	mA
I <sub>CBO</sub>	V <sub>CB</sub> = 60V			0.5	mA
I <sub>EBO</sub>	V <sub>EB</sub> = 5V			1	mA
H <sub>FE</sub>	I <sub>C</sub> = 1A, V <sub>CE</sub> = 2V	25			
H <sub>FE</sub>	I <sub>C</sub> = 3A, V <sub>CE</sub> = 2V	15		100	
H <sub>FE</sub>	I <sub>C</sub> = 8A, V <sub>CE</sub> = 4V	5			
V <sub>CE(SAT)</sub>	I <sub>C</sub> = 5A, I <sub>B</sub> = 0.5A			1	V
V <sub>CE(SAT)</sub>	I <sub>C</sub> = 8A, I <sub>B</sub> = 1.6A			3	V
V <sub>BE(SAT)</sub>	I <sub>C</sub> = 5A, I <sub>B</sub> = 0.5A			1.6	V
V <sub>BE(ON)</sub>	I <sub>C</sub> = 3A, V <sub>CE</sub> = 2V			1.5	V
C <sub>obo</sub>	V <sub>CB</sub> = 10V			300	pF
f <sub>t</sub>	I <sub>C</sub> = 0.5A, V <sub>CE</sub> = 10V, f = 1 MHz	4			MHz
SOA	TO-3, V <sub>CE</sub> = 45V, t = 1 sec	3.3			A
SOA	TO-220, V <sub>CE</sub> = 45V, t = 1 sec	1.55			A
P <sub>D(MAX)</sub>	TO-3	150			W
P <sub>D(MAX)</sub>	TO-220	70			W
$\theta_{jc}$	TO-3			1.16	$^{\circ}$ C/W
$\theta_{jc}$	TO-220			1.78	$^{\circ}$ C/W

**PRINCIPAL DEVICE TYPES**
**TO-3**

2N3713	2N5758	2N5877
2N3714	2N5759	2N5878
2N3715	2N5760	MJ2840
2N3716		MJ2841

Typical Normalized Pulsed Current Gain vs Collector Current

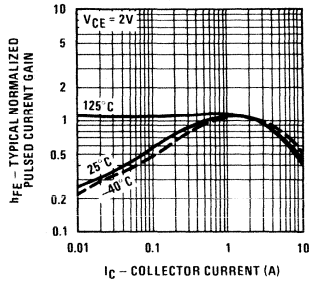

Collector-Emitter Saturation Voltage vs Collector Current

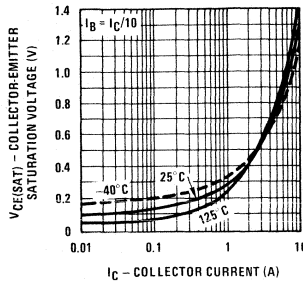

Base-Emitter Saturation Voltage vs Collector Current

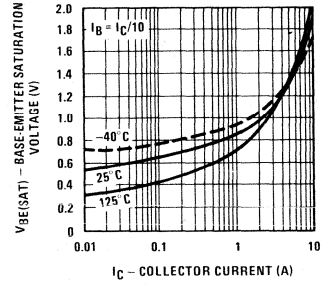

Base-Emitter ON Voltage vs Collector Current

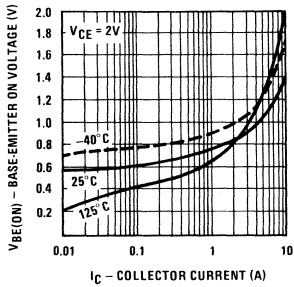

Junction Capacitance vs Reverse Bias Voltage

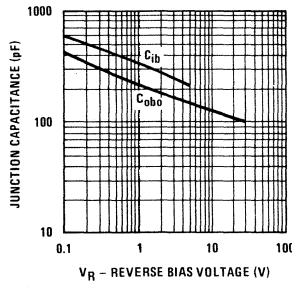

Maximum Power Dissipation vs Case Temperature

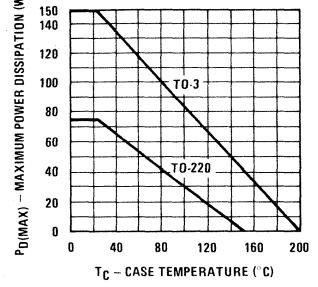

Safe Operating Area TO-3

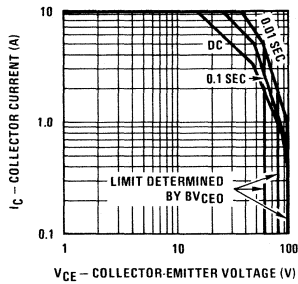

Safe Operating Area TO 220

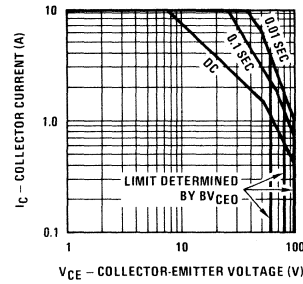

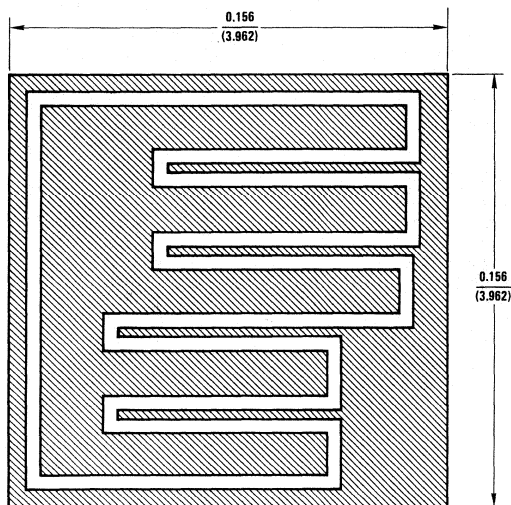
**DESCRIPTION**

Process 4C is a double epitaxial silicon mesa transistor with diffused emitter.

**APPLICATION**

This device was designed for general purpose amplifier and switching circuits where a large safe operating area is required.

PARAMETER	CONDITIONS	MIN	TYP	MAX	UNITS
$V_{CE0}$	$I_C = 200 \text{ mA}$	60	80	150	V
$V_{CB0}$	$I_C = 500 \mu\text{A}$	60		100	V
$V_{EBO}$	$I_E = 100 \mu\text{A}$	5			V
$I_{CEX}$	$V_{CE} = 60\text{V}, V_{BE} = -1.5\text{V}$			0.5	mA
$I_{CBO}$	$V_{CB} = 60\text{V}$			0.5	mA
$I_{EBO}$	$V_{EB} = 5\text{V}$			1.0	mA
$H_{FE}$	$I_C = 2\text{A}, V_{CE} = 4\text{V}$	35			
$H_{FE}$	$I_C = 6\text{A}, V_{CE} = 4\text{V}$	20		100	
$H_{FE}$	$I_C = 12\text{A}, V_{CE} = 4\text{V}$	5			
$V_{CE(SAT)}$	$I_C = 7\text{A}, I_B = 0.7\text{A}$			1	V
$V_{CE(SAT)}$	$I_C = 12\text{A}, I_B = 2.4\text{A}$			4	V
$V_{BE(SAT)}$	$I_C = 7\text{A}, I_B = 0.7\text{A}$			1.6	V
$V_{BE(ON)}$	$I_C = 12\text{A}, V_{CE} = 4\text{V}$			2.5	V
$C_{obo}$	$V_{CB} = 10\text{V}$			400	pF
SOA	TO-3, $V_{CE} = 50\text{V}, t = 1 \text{ sec}$	3.0			A
$f_t$	$I_C = 1\text{A}, V_{CE} = 10\text{V}, f = 1 \text{ MHz}$	4			MHz
$P_D(\text{MAX})$	TO-3	175			W
$P_D(\text{MAX})$	TO-220	75			W
$\theta_{jc}$	TO-3			1.0	$^{\circ}\text{C/W}$
$\theta_{jc}$	TO-220			1.66	$^{\circ}\text{C/W}$

**PRINCIPAL DEVICE TYPES**
**TO-3**

2N5632	2N5881
2N5633	2N5882
2N5634	BD351



Typical Normalized Pulsed Current Gain vs Collector Current

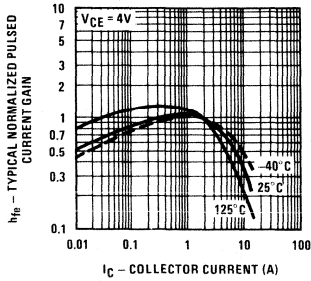

Collector-Emitter Saturation Voltage vs Collector Current

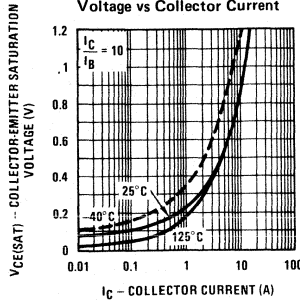

Base-Emitter Saturation Voltage vs Collector Current

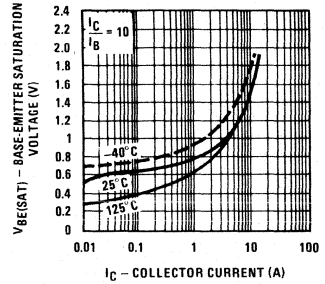

Base-Emitter ON Voltage vs Collector Current

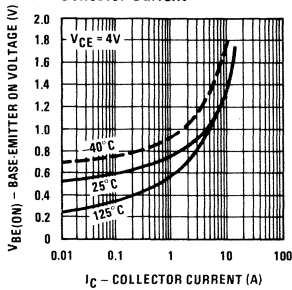

Junction Capacitance vs Reverse Bias Voltage

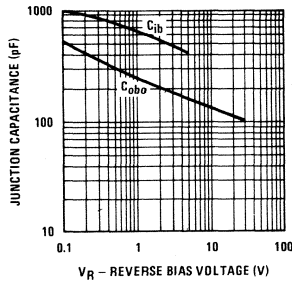

Maximum Power Dissipation vs Case Temperature

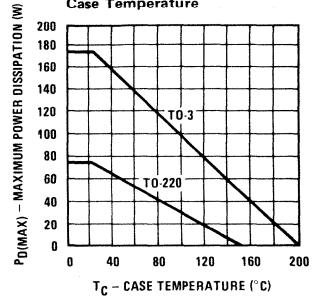

Safe Operating Area TO-3

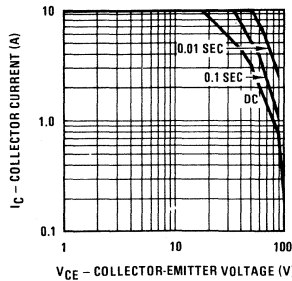

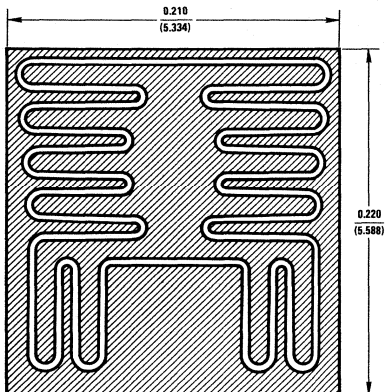

### DESCRIPTION

Process 4G is a double epitaxial silicon mesa transistor with diffused emitter.

### APPLICATION

This device was designed for general purpose amplifier and switching circuits where a large safe operating area is required.

PARAMETER	CONDITIONS	MIN	TYP	MAX	UNITS
$BV_{CEO}$	$I_C = 200 \text{ mA}$	60	80	150	V
$BV_{CBO}$	$I_C = 1 \text{ mA}$	60			V
$BV_{EBO}$	$I_E = 100 \mu\text{A}$	5			V
$I_{CEO}$	$V_{CE} = 30\text{V}$			2	mA
$I_{CEX}$	$V_{CE} = 60\text{V}, V_{BE} = -1.5\text{V}$			1	mA
$I_{CBO}$	$V_{CB} = 60\text{V}$			1	mA
$I_{EBO}$	$V_{BE} = 5\text{V}$			1	mA
$H_{FE}$	$I_C = 3\text{A}, V_{CE} = 4\text{V}$	35			
$H_{FE}$	$I_C = 10\text{A}, V_{CE} = 4\text{V}$	20		100	
$H_{FE}$	$I_C = 20\text{A}, V_{CE} = 4\text{V}$	5			
$V_{CE(SAT)}$	$I_C = 15\text{A}, I_B = 1.5\text{A}$			1	V
$V_{CE(SAT)}$	$I_C = 20\text{A}, I_B = 4\text{A}$			4	V
$V_{BE(SAT)}$	$I_C = 15\text{A}, I_B = 1.5\text{A}$			1.8	V
$V_{BE(ON)}$	$I_C = 20\text{A}, V_{CE} = 4\text{V}$			2.5	V
$C_{obo}$	$V_{CB} = 10\text{V}$			500	pF
$f_t$	$I_C = 1\text{A}, V_{CE} = 10\text{V}, f = 1 \text{ MHz}$	4			MHz
$P_D(\text{MAX})$	TO-3	200			W
$\theta_{jc}$	TO-3			0.875	$^{\circ}\text{C/W}$

### PRINCIPAL DEVICE TYPES

#### TO-3

2N5629  
2N5630  
2N5631  
2N5885  
2N5886  
2N5301  
2N5302  
2N5303  
MJ802

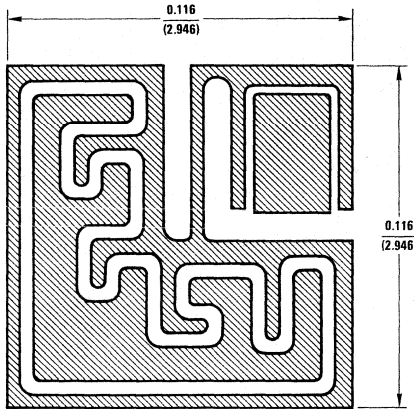
**DESCRIPTION**

Process 4K is a double epitaxial silicon mesa Darlington transistor.

**APPLICATION**

The 4K was designed for general purpose amplifier and low-speed switching applications.

PARAMETER	CONDITIONS	MIN	TYP	MAX	UNITS
$BV_{CEO}$	$I_C = 100 \text{ mA}$	60	80	150	V
$BV_{CBO}$	$I_C = 500 \mu\text{A}$	60			V
$BV_{EBO}$	$I_E = 5 \text{ mA}$	5			V
$I_{CEO}$	$V_{CE} = 30\text{V}$			0.5	mA
$I_{CEX}$	$V_{CE} = 60\text{V}, V_{EB} = 1.5\text{V}$			0.5	mA
$I_{EBO}$	$V_{BE} = 5\text{V}$			2.0	mA
$H_{FE}$	$I_C = 4\text{A}, V_{CE} = 3\text{V}$	750		18000	
$H_{FE}$	$I_C = 8\text{A}, V_{CE} = 3\text{V}$	100			
$V_{CE(SAT)}$	$I_C = 4\text{A}, I_B = 16 \text{ mA}$			2	V
$V_{CE(SAT)}$	$I_C = 8\text{A}, I_B = 80 \text{ mA}$			3	V
$V_{BE(SAT)}$	$I_C = 8\text{A}, I_B = 80 \text{ mA}$			4	V
$V_{BE(ON)}$	$I_C = 4\text{A}, V_{CE} = 3\text{V}$			2.8	V
$C_{obo}$	$V_{CB} = 10\text{V}$			200	pF
$f_t$	$I_C = 3\text{A}, V_{CE} = 3\text{V}, f = 1 \text{ MHz}$	4			MHz
$P_D(\text{MAX})$	TO-3	120			W
$P_D(\text{MAX})$	TO-220	60			W
$\theta_{jc}$	TO-3			1.66	$^{\circ}\text{C/W}$
$\theta_{jc}$	TO-220			2.08	$^{\circ}\text{C/W}$

**PRINCIPAL DEVICE TYPES**

<b>TO-3</b>		<b>TO-220</b>	
2N6055	2N6385	TIP121	TIP132
2N6056	MJ1000	TIP122	SE9300
2N6383	MJ1001	TIP130	SE9301
2N6384		TIP131	SE9302

Typical Normalized Pulsed Current Gain vs Collector Current

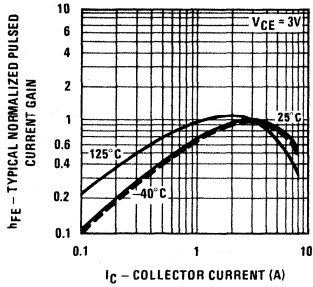

Collector-Emitter Saturation Voltage vs Collector Current

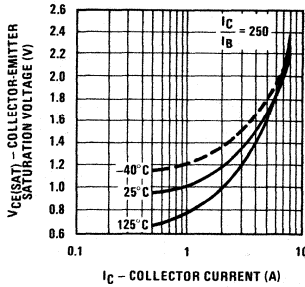

Base-Emitter Saturation Voltage vs Collector Current

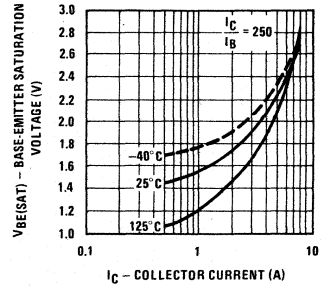

Base-Emitter ON Voltage vs Collector Current

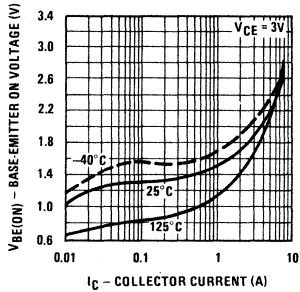

Junction Capacitance vs Reverse Bias Voltage

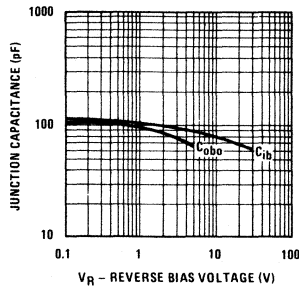

Maximum Power Dissipation vs Case Temperature

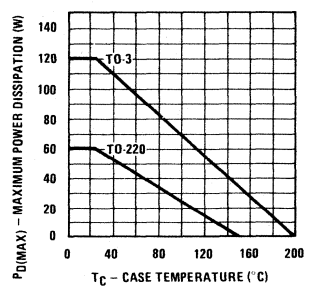

Safe Operating Area TO-3

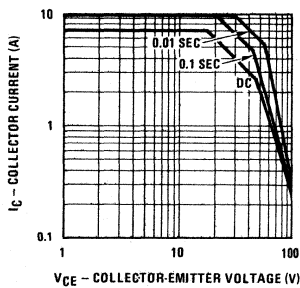

Safe Operating Area TO-220

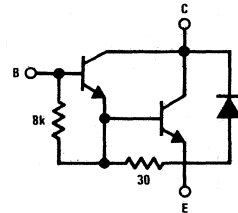
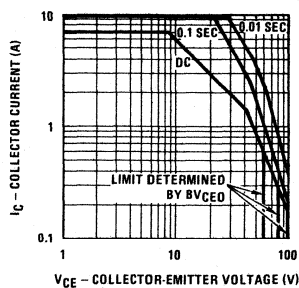

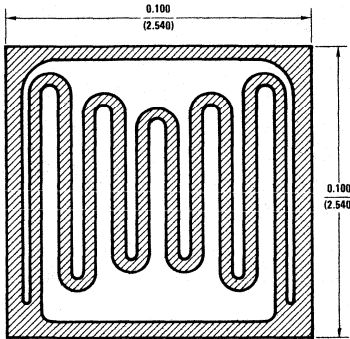
**DESCRIPTION**

Process 5A is a double epitaxial silicon PNP mesa device with a diffused emitter.

**APPLICATION**

This device was designed for general purpose power amplifier and switching circuits where a large safe operating area is required.

PARAMETER	TEST CONDITIONS	MIN	TYP	MAX	UNITS
$BV_{CEO}$	$I_C = 200 \text{ mA}$ , (Note 1)	40		100	V
$BV_{CBO}$	$I_C = 1 \text{ mA}$	60		150	V
$BV_{EBO}$	$I_E = 0.5 \text{ mA}$	5	7		V
$I_{CEO}$	$V_{CE} = BV_{CEO} - 10V$		10	200	$\mu\text{A}$
$I_{CBO}$	$V_{CB} = BV_{CEO} + 20V$		1	20	$\mu\text{A}$
$I_{EBO}$	$V_{EB} = 5V$		1	500	$\mu\text{A}$
$h_{FE}$	$I_C = 2.5 \text{ A}$ , $V_{CE} = 2V$	20		200	
$V_{CE(SAT)}$	$I_C = 4 \text{ A}$ , $I_B = 0.4 \text{ A}$		0.5	0.6	V
$V_{BE(ON)}$	$I_C = 5 \text{ A}$ , $V_{CE} = 2V$		1.2	1.3	V
$S_{OA}$	$I_C = 3 \text{ A}$ , $t = 1 \text{ sec}$	30			V
$f_t$	$I_C = 0.5 \text{ A}$ , $V_{CE} = 5V$ , $f = 1 \text{ MHz}$	2			
$t_d$	$I_C = 5 \text{ A}$ , $I_{B1} = I_{B2} = 0.5 \text{ A}$ $V_{CC} = 40V$		0.03		$\mu\text{s}$
$t_r$	$I_C = 5 \text{ A}$ , $I_{B1} = I_{B2} = 0.5 \text{ A}$ , $V_{CC} = 40V$		0.27		$\mu\text{s}$
$t_s$	$I_C = 5 \text{ A}$ , $I_{B1} = I_{B2} = 0.5 \text{ A}$ , $V_{CC} = 40V$		0.3		$\mu\text{s}$
$t_f$	$I_C = 5 \text{ A}$ , $I_{B1} = I_{B2} = 0.5 \text{ A}$ , $V_{CC} = 40V$		0.37		$\mu\text{s}$
$P_{D(MAX)}$	TO-220	60			
$\theta_{jc}$	TO-220			2.08	$^{\circ}\text{C/W}$

**Note 1:** Pulsed measurement = 300  $\mu\text{s}$  pulse width.

**PRINCIPAL DEVICE TYPES**
**TO-220**

NSP5974	NSP2955	D45H4
NSP5975	2N6489	D45H5
NSP5976	2N6490	D45H7
NSP2010	2N6491	D45H8
NSP2011	D45H1	D45H10
NSP105	D45H2	D45H11

Typical Normalized Pulsed Current Gain vs Collector Current

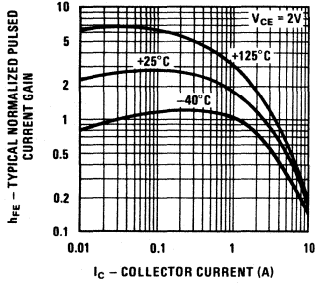

Collector-Emitter Saturation Voltage vs Collector Current

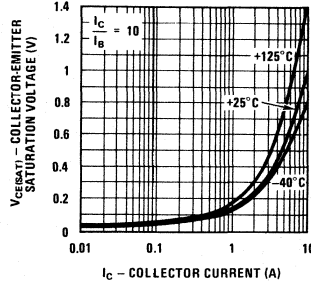

Base-Emitter Saturation Voltage vs Collector Current

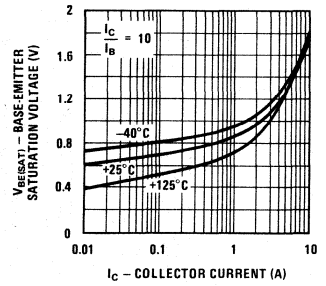

Base-Emitter "ON" Voltage vs Collector Current

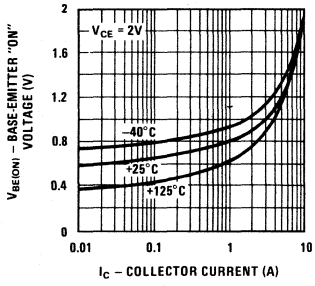

Gain Bandwidth Product vs Collector Current

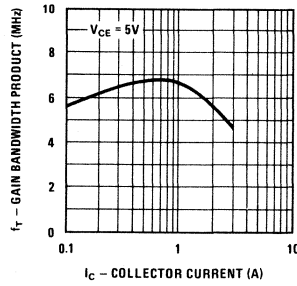

Junction Capacitance vs Reverse Bias Voltage

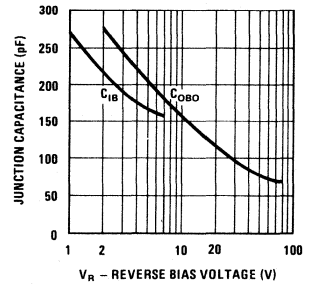

Safe Operating Area TO-3

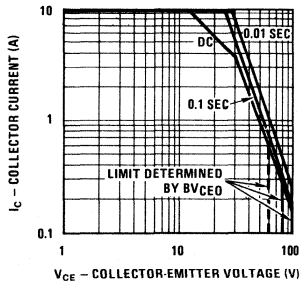

Safe Operating Area TO-220

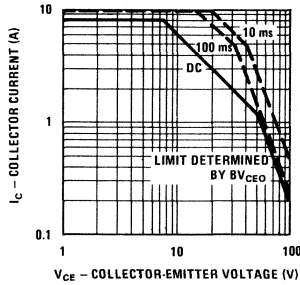

Maximum Power Dissipation vs Case Temperature

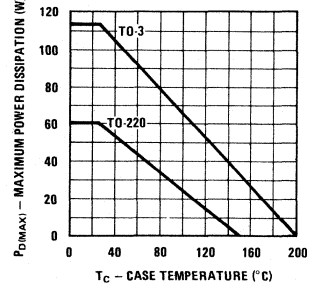

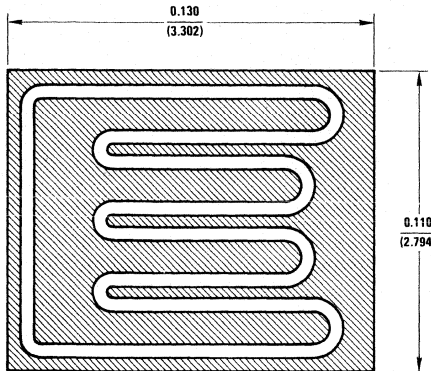
**DESCRIPTION**

Process 5B is a double epitaxial silicon mesa transistor with diffused emitter.

**APPLICATION**

This device was designed for general purpose amplifier and switching circuits where a large safe operating area is required.

PARAMETER	CONDITIONS	MIN	TYP	MAX	UNITS
$BV_{CEO}$	$I_C = 200 \text{ mA}$	60	80	150	V
$BV_{CBO}$	$I_C = 500 \mu\text{A}$	60			V
$BV_{EBO}$	$I_E = 100 \mu\text{A}$	5			V
$I_{CEO}$	$V_{CE} = 30\text{V}$			2	mA
$I_{CEX}$	$V_{CE} = 60\text{V}, V_{BE} = -1.5\text{V}$			1	mA
$I_{CBO}$	$V_{CB} = 60\text{V}$			1	mA
$I_{EBO}$	$V_{BE} = 5\text{V}$			1	mA
$H_{FE}$	$I_C = 1\text{A}, V_{CE} = 2\text{V}$	25			
$H_{FE}$	$I_C = 3\text{A}, V_{CE} = 2\text{V}$	15		100	
$H_{FE}$	$I_C = 8\text{A}, V_{CE} = 4\text{V}$	5			
$V_{CE(SAT)}$	$I_C = 5\text{A}, I_B = 0.5\text{A}$			1	V
$V_{CE(SAT)}$	$I_C = 8\text{A}, I_B = 1.6\text{A}$			4	V
$V_{BE(SAT)}$	$I_C = 5\text{A}, I_B = 0.5\text{A}$			1.8	V
$V_{BE(ON)}$	$I_C = 3\text{A}, V_{CE} = 2\text{V}$			2.5	V
$C_{obo}$	$V_{CB} = 10\text{V}$			500	pF
$f_t$	$I_C = 0.5\text{A}, V_{CE} = 10\text{V}, f = 1 \text{ MHz}$	4			MHz
$P_D(\text{MAX})$	TO-3	150			W
$P_D(\text{MAX})$	TO-220	70			W
$\theta_{jc}$	TO-3			1.16	$^{\circ}\text{C/W}$
$\theta_{jc}$	TO-220			1.78	$^{\circ}\text{C/W}$

**PRINCIPAL DEVICE TYPES**
**TO-3**

2N3789	2N4908	2N6227
2N3790	2N4909	2N6228
2N3791	2N5875	MJ2940
2N3792	2N5876	MJ2941
2N4907	2N6226	

**Typical Normalized Pulsed Current Gain vs Collector Current**

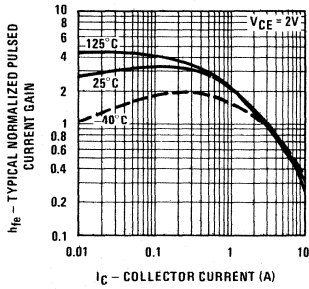

**Collector-Emitter Saturation Voltage vs Collector Current**

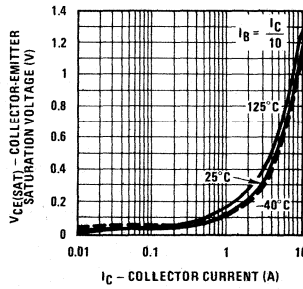

**Base-Emitter Saturation Voltage vs Collector Current**

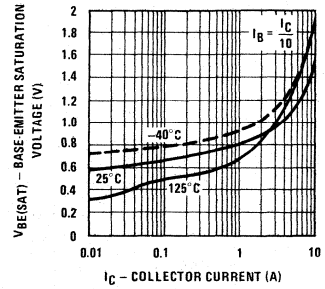

**Base-Emitter ON Voltage vs Collector Current**

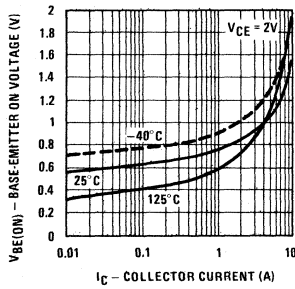

**Junction Capacitance vs Reverse Bias Voltage**

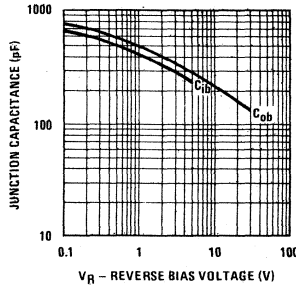

**Maximum Power Dissipation vs Case Temperature**

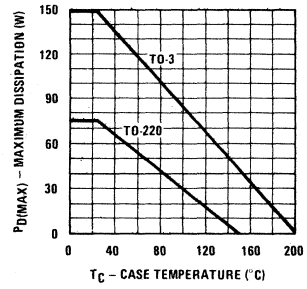

**Safe Operating Area TO-3**

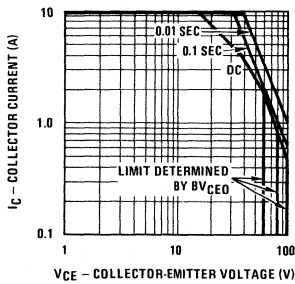

**Safe Operating Area TO-220**

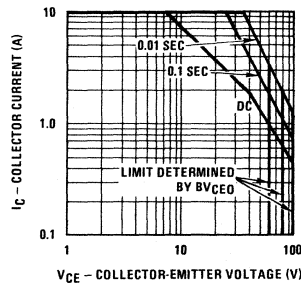

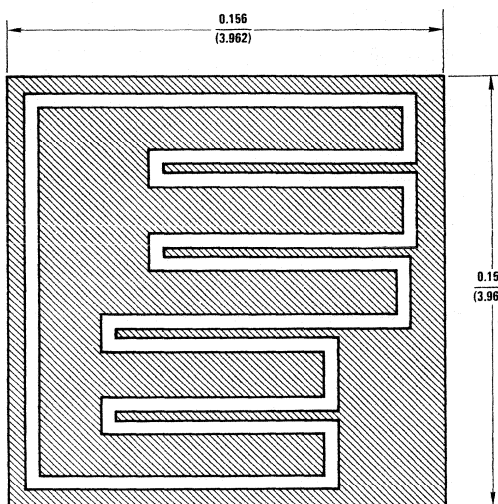

**DESCRIPTION**

Process 5C is a double epitaxial silicon mesa transistor with diffused emitter.

**APPLICATION**

This device was designed for general purpose amplifier and switching circuits where a large safe operating area is required.

PARAMETER	CONDITIONS	MIN	TYP	MAX	UNITS
$V_{CE0}$	$I_C = 200 \text{ mA}$	60	80	150	V
$V_{CB0}$	$I_C = 500 \mu\text{A}$	60		100	V
$V_{EBO}$	$I_E = 100 \mu\text{A}$	5			V
$I_{CEX}$	$V_{CE} = 60\text{V}, V_{BE} = 1.5\text{V}$			0.5	mA
$I_{CBO}$	$V_{CB} = 60\text{V}$			0.5	mA
$I_{EBO}$	$V_{EB} = 5\text{V}$			1.0	mA
$H_{FE}$	$I_C = 2\text{A}, V_{CE} = 4\text{V}$	35			
$H_{FE}$	$I_C = 6\text{A}, V_{CE} = 4\text{V}$	20		100	
$H_{FE}$	$I_C = 12\text{A}, V_{CE} = 4\text{V}$	5			
$V_{CE(SAT)}$	$I_C = 7\text{A}, I_B = 0.7\text{A}$			1	V
$V_{CE(SAT)}$	$I_C = 12\text{A}, I_B = 2.4\text{A}$			4	V
$V_{BE(SAT)}$	$I_C = 7\text{A}, I_B = 0.7\text{A}$			1.6	V
$V_{BE(ON)}$	$I_C = 12\text{A}, V_{CE} = 4\text{V}$			2.5	V
$C_{obo}$	$V_{CB} = 10\text{V}$			600	pF
$f_t$	$I_C = 1\text{A}, V_{CE} = 10\text{V}, f = 1 \text{ MHz}$	4			MHz
$P_D(\text{MAX})$	TO-3	175			W
$P_D(\text{MAX})$	TO-220	75			W
$\theta_{jc}$	TO-3			1.0	$^{\circ}\text{C/W}$
$\theta_{jc}$	TO-220			1.66	$^{\circ}\text{C/W}$

**PRINCIPAL DEVICE TYPES**
**TO-3**

2N6229	2N5879
2N6230	2N5880
2N6231	BD350

Typical Normalized Pulsed Current Gain vs Collector Current

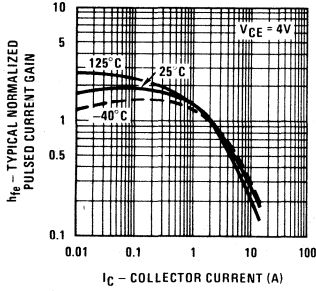

Collector-Emitter Saturation Voltage vs Collector Current

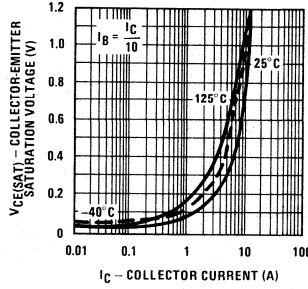

Base-Emitter Saturation Voltage vs Collector Current

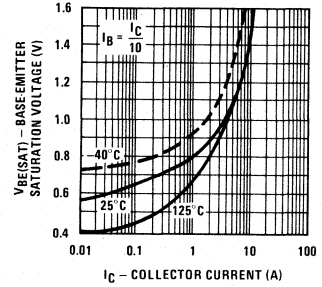

Base-Emitter ON Voltage vs Collector Current

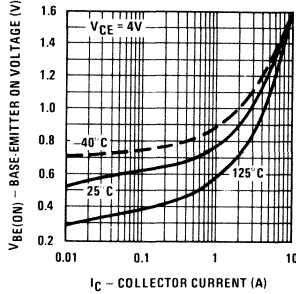

Junction Capacitance vs Reverse Bias Voltage

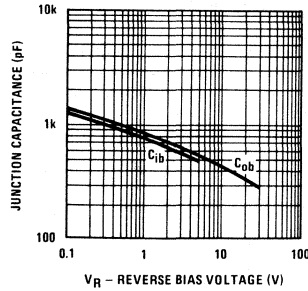

Maximum Power Dissipation vs Case Temperature

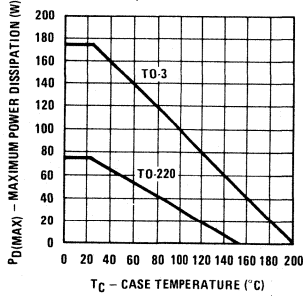

Safe Operating Area TO-3

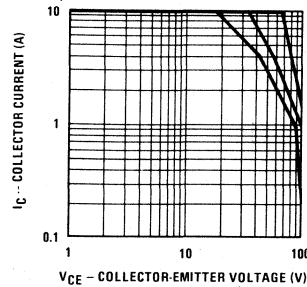

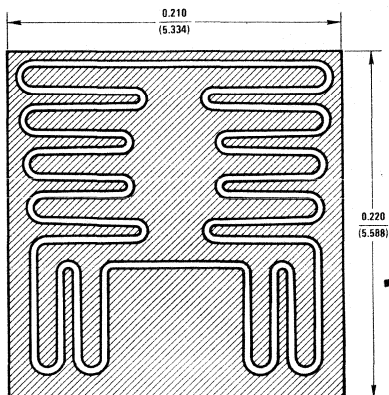
**DESCRIPTION**

Process 5G is a double epitaxial silicon mesa transistor with diffused emitter.

**APPLICATION**

This device was designed for general purpose amplifier and switching circuits where a large safe operating area is required.

PARAMETER	CONDITIONS	MIN	TYP	MAX	UNITS
$BV_{CEO}$	$I_C = 200 \text{ mA}$	60	80	150	V
$BV_{CBO}$	$I_C = 1 \text{ mA}$	60			V
$BV_{EBO}$	$I_E = 100 \mu\text{A}$	5			V
$I_{CEO}$	$V_{CE} = 30\text{V}$			2	mA
$I_{CEX}$	$V_{CE} = 60\text{V}, V_{BE} = 1.5\text{V}$			1	mA
$I_{CBO}$	$V_{CB} = 60\text{V}$			1	mA
$I_{EBO}$	$V_{EB} = 5\text{V}$			1	mA
$H_{FE}$	$I_C = 3\text{A}, V_{CE} = 4\text{V}$	35			
$H_{FE}$	$I_C = 10\text{A}, V_{CE} = 4\text{V}$	20		100	
$H_{FE}$	$I_C = 20\text{A}, V_{CE} = 4\text{V}$	5			
$V_{CE(SAT)}$	$I_C = 15\text{A}, I_B = 1.5\text{A}$			1	V
$V_{CE(SAT)}$	$I_C = 20\text{A}, I_B = 4\text{A}$			4	V
$V_{BE(SAT)}$	$I_C = 15\text{A}, I_B = 1.5\text{A}$			1.8	V
$V_{BE(ON)}$	$I_C = 20\text{A}, V_{CE} = 4\text{V}$			2.5	V
$C_{obo}$	$V_{CB} = 10\text{V}$			800	pF
$f_t$	$I_C = 1\text{A}, V_{CE} = 10\text{V}, f = 1 \text{ MHz}$	4			MHz
$P_D(\text{MAX})$		200			W
$\theta_{jc}$				0.875	$^{\circ}\text{C/W}$

**PRINCIPAL DEVICE TYPES**
**TO-3**

2N6029  
2N6030  
2N6031  
MJ4502

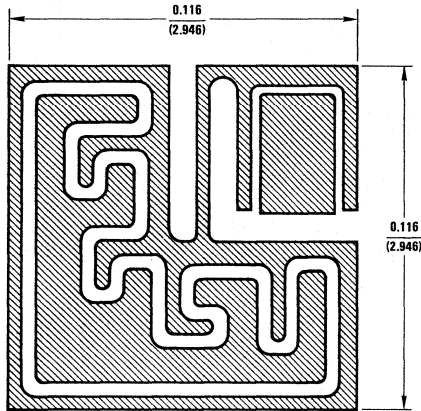
**DESCRIPTION**

Process 5K is a double epitaxial silicon mesa Darlington transistor.

**APPLICATION**

The 5K was designed for general purpose amplifier and low-speed switching applications.

PARAMETER	CONDITIONS	MIN	TYP	MAX	UNITS
BV <sub>CEO</sub>	I <sub>C</sub> = 100 mA	60	80	150	V
BV <sub>CBO</sub>	I <sub>C</sub> = 500 μA	60			V
BV <sub>EBO</sub>	I <sub>E</sub> = 5 mA	5			V
I <sub>CEO</sub>	V <sub>CE</sub> = 30V			0.5	mA
I <sub>CEX</sub>	V <sub>CE</sub> = 60V, V <sub>EB</sub> = 1.5V			0.5	mA
I <sub>EBO</sub>	V <sub>BE</sub> = 5V			2.0	mA
H <sub>FE</sub>	I <sub>C</sub> = 4A, V <sub>CE</sub> = 3V	750		18000	
H <sub>FE</sub>	I <sub>C</sub> = 8A, V <sub>CE</sub> = 3V	100			
V <sub>CE(SAT)</sub>	I <sub>C</sub> = 4A, I <sub>B</sub> = 16 mA			2	V
V <sub>CE(SAT)</sub>	I <sub>C</sub> = 8A, I <sub>B</sub> = 80 mA			3	V
V <sub>BE(SAT)</sub>	I <sub>C</sub> = 8A, I <sub>B</sub> = 80 mA			4	V
V <sub>BE(ON)</sub>	I <sub>C</sub> = 4A, V <sub>CE</sub> = 3V			2.8	V
C <sub>obo</sub>	V <sub>CB</sub> = 10V			300	pF
f <sub>t</sub>	I <sub>C</sub> = 3A, V <sub>CE</sub> = 3V, f = 1 MHz	4			MHz
PD(MAX)	TO-3	120			W
PD(MAX)	TO-220	60			W
θ <sub>jc</sub>	TO-3			1.66	°C/W
θ <sub>jc</sub>	TO-220			2.08	°C/W

**PRINCIPAL DEVICE TYPES**

<b>TO-3</b>	<b>TO-220</b>	
2N6053	TIP125	TIP136
2N6054	TIP126	TIP137
MJ900	TIP127	SE9401
MJ901	TIP135	SE9402

**Typical Normalized Pulsed Current Gain vs Collector Current**

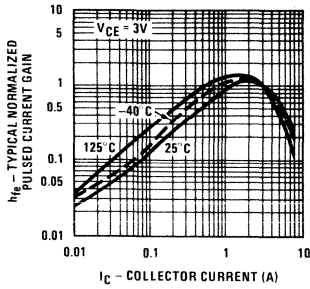

**Collector-Emitter Saturation Voltage vs Collector Current**

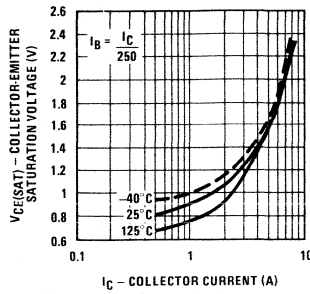

**Base-Emitter Saturation Voltage vs Collector Current**

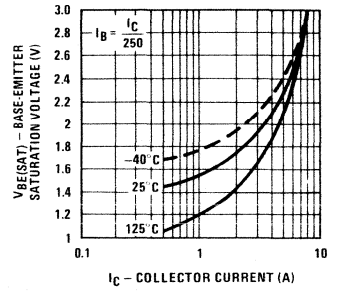

**Base-Emitter ON Voltage vs Collector Current**

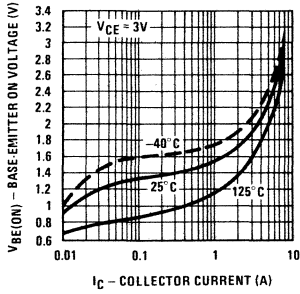

**Junction Capacitance vs Reverse Bias Voltage**

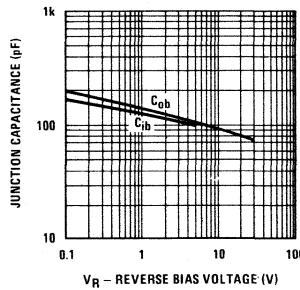

**Maximum Power Dissipation vs Case Temperature**

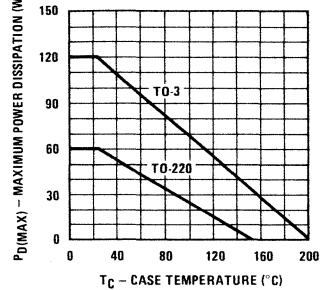

**Safe Operating Area TO 3**

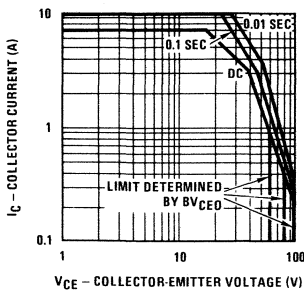

**Safe Operating Area TO-220**

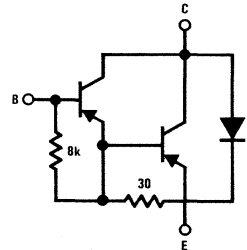
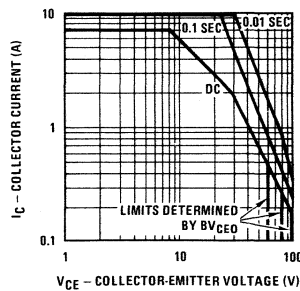





**Section 8**  
**JFET Selection**  
**Guide**



## N-Channel FETs

### SWITCHES/CHOPPERS

Type No.	Case Style	BV <sub>GSD</sub> (V) @ I <sub>G</sub> (μA) Min	BV <sub>GSD</sub> (V) @ I <sub>G</sub> (μA) Max	I <sub>GSS</sub> (nA) @ V <sub>DG</sub> (V)	I <sub>D(off)</sub> (nA) @ V <sub>DS</sub> (V)	V <sub>P</sub> (V) @ V <sub>DS</sub> (V)	I <sub>D</sub> (nA)	I <sub>DSS</sub> (mA) Min	I <sub>DSS</sub> (mA) Max @ V <sub>DS</sub> (V)	f <sub>td(on)</sub> (ns) @ I <sub>D</sub> (mA) Max	C <sub>iss</sub> (pF) @ V <sub>DS</sub> (V) Max	C <sub>iss</sub> (pF) @ V <sub>DS</sub> (V) Max	V <sub>GS</sub> (V)	V <sub>GS</sub> (V)	V <sub>GS</sub> (V)	V <sub>GS</sub> (V)	t <sub>on</sub> (ns) Max	t <sub>off</sub> (ns) Max	Process No.	Pkg. No.	
2N3824	TO-72	50	1	0.1	30	15	-8	0.1	15	8	15	1	0	0	0	-8	3	0	55	25	
2N3966	TO-72	30	1	0.1	20	10	-7	0.1	10	4	6	10	0	0	0	-7	1.5	0	50	25	
2N3970	TO-18	40	1	0.25*	20	20	-12	0.25	20	4	10	20	1	50	150	20	30	30	51	02	
2N3971	TO-18	40	1	0.25*	20	20	12	0.25	20	2	5	20	1	25	75	20	60	30	51	02	
2N3972	TO-18	40	1	0.25*	20	20	-12	0.25	20	0.5	3	20	1	5	30	20	100	80	51	02	
*2N4091	TO-18	40	1	0.2*	20	20	-12	0.2	20	5	10	20	1	30	20	0	16	20	51	02	
*2N4092	TO-18	40	1	0.2*	20	20	-8	0.2	20	2	7	20	1	15	20	0	16	20	51	02	
*2N4093	TO-18	40	1	0.2*	20	20	-6	0.2	20	1	5	20	1	8	20	0	16	20	51	02	
2N4391	TO-18	40	1	0.1	20	0.1	-12	0.1	20	4	10	20	1	50	150	20	30	30	51	02	
2N4392	TO-18	40	1	0.1	20	0.1	-7	0.1	20	2	5	20	1	25	75	20	60	30	51	02	
2N4393	TO-18	40	1	0.1	20	0.1	-5	0.1	20	0.5	3	20	1	5	30	20	100	80	51	02	
*2N4856	TO-18	40	1	0.25	20	0.25	-10	0.25	15	4	10	15	5	50	15	15	25	25	51	02	
2N4856A	TO-18	40	1	0.25	20	0.25	-10	0.25	15	4	10	15	5	50	15	15	25	25	51	02	
*2N4857	TO-18	40	1	0.25	20	0.25	-10	0.25	15	2	6	15	5	20	100	15	40	10	51	02	
2N4857A	TO-18	40	1	0.25	20	0.25	-10	0.25	15	2	6	15	5	20	100	15	40	10	51	02	
*2N4858	TO-18	40	1	0.25	20	0.25	-10	0.25	15	0.8	4	15	5	8	80	15	60	20	51	02	
2N4858A	TO-18	40	1	0.25	20	0.25	-10	0.25	15	0.8	4	15	5	8	80	15	60	16	80	51	02
*2N4859	TO-18	30	1	0.25	15	0.25	-10	0.25	15	4	10	15	5	50	15	25	25	25	51	02	
2N4859A	TO-18	30	1	0.25	15	0.25	-10	0.25	15	4	10	15	5	50	15	25	25	25	51	02	
*2N4860	TO-18	30	1	0.25	15	0.25	-10	0.25	15	2	6	15	5	20	100	15	40	10	51	02	
2N4860A	TO-18	30	1	0.25	15	0.25	-10	0.25	15	2	6	15	5	20	100	15	40	10	51	02	
*2N4861	TO-18	30	1	0.25	15	0.25	-10	0.25	15	0.8	4	15	5	8	80	15	60	20	51	02	
2N4861A	TO-18	30	1	0.25	15	0.25	-10	0.25	15	0.8	4	15	5	8	80	15	60	16	80	51	02
2N5432	TO-52	25	1	0.2	15	0.2	-10	0.2	5	4	10	5	3	150	15	5	10	30	58	07	
2N5433	TO-52	25	1	0.2	15	0.2	-10	0.2	5	3	9	5	3	100	15	7	10	30	58	07	
2N5434	TO-52	25	1	0.2	15	0.2	-10	0.2	5	1	4	5	3	30	15	10	10	30	58	07	
2N5555	TO-92	25	10	1	15	10	-10	10	12	(10)				5	15	0	1.2	0	50	72	

• Note. JAN qualified per applicable MIL-S-19500 specification.





# N-Channel FETs

## SWITCHES/CHOPPERS (Continued)

Type No.	Case Style	BV <sub>GSS</sub> BV <sub>GDO</sub> (V) @ I <sub>G</sub> ( $\mu$ A)	I <sub>GSS</sub> *I <sub>DGO</sub> (nA) @ V <sub>DG</sub> (V)	I <sub>D(off)</sub> (nA) @ V <sub>DG</sub> (V)	V <sub>GS</sub> (V)	V <sub>p</sub> (V) @ V <sub>DS</sub> (V)	I <sub>D</sub> (nA)	I <sub>DSS</sub> (mA)	V <sub>DS</sub> (V)	r <sub>ds(on)</sub> ( $\Omega$ ) @ I <sub>D</sub> (mA)	C <sub>iss</sub> (pF) @ V <sub>DS</sub> (V)	V <sub>GS</sub> (V)	I <sub>pF</sub> @ V <sub>DS</sub> (V)	C <sub>rss</sub> (pF) @ V <sub>DS</sub> (V)	V <sub>GS</sub> (V)	t <sub>on</sub> (ns) Max	t <sub>off</sub> (ns) Max	Process No.	Pkg. No.	
2N5638	TO-92	30	10	1	15	-12	(12)	50	20	30	1	10	0	0	-12	4	0	-12	51	72
2N5639	TO-92	30	10	1	15	-8	(8)	25	20	60	1	10	0	0	-8	4	0	-8	51	72
2N5640	TO-92	30	10	1	15	-6	(6)	5	20	100	1	10	0	0	-6	4	0	-6	51	72
2N5653	TO-92	30	10	1	15	-12	(12)	40	20	50	1	10	0	0	-12	3.5	0	-12	9	15
2N5654	TO-92	25	10	1	15	-8	(8)	15	20	100	1	10	0	0	-8	14	30	51	72	
J138	TO-92	25	1	3	15	3	16	80	15	8	10	130	0	0	-10	15	136	58	72	
J109	TO-92	25	1	3	15	3	6	40	15	12	10	130	0	0	-10	15	136	58	72	
J110	TO-92	25	1	3	15	3	5	10	15	18	10	130	0	0	-10	15	136	58	72	
J111	TO-92	35	1	1	15	3	10	20	15	30	1	10	0	0	-10	15	136	51	72	
J112	TO-92	35	1	1	15	3	5	5	15	50	1	10	0	0	-10	15	136	51	72	
J113	TO-92	35	1	1	15	3	5	1000	15	100	1	10	0	0	-10	15	135	51	72	
J114	TO-92	25	1	1	15	3	10	5	15	150	1	14	0	0	-10	12	16	120	90	
PN4091	TO-92	40	1	1*	20	-12	5	30	20	30	1	16	20	0	0	25	40	51	72	
PN4092	TO-92	40	1	1*	20	-8	7	15	20	50	1	16	20	0	0	36	60	51	72	
PN4093	TO-92	40	1	1*	20	-6	1	8	20	80	1	16	20	0	0	60	80	51	72	
PN4391	TO-92	40	1	1	20	-12	4	150	20	30	1	14	20	0	0	20	36	51	72	
PN4392	TO-92	40	1	1	20	-7	2	25	20	60	1	14	20	0	0	40	80	51	72	
PN4393	TO-92	40	1	1	20	-5	3	5	30	100	1	14	20	0	0	56	130	51	72	
PN4856	TO-92	40	1	1	20	-10	4	50	15	26	1	16	0	0	-10	8	9	25	51	72
PN4857	TO-92	40	1	1	20	-10	2	20	15	40	1	16	0	0	-10	10	10	50	51	72
PN4858	TO-92	40	1	1	20	-10	0.8	8	15	60	1	18	0	0	-10	8	0	100	51	72
PN4859	TO-92	30	1	1	15	-10	4	50	15	25	1	18	0	0	-10	9	25	51	72	
PN4860	TO-92	30	1	1	15	-10	2	100	15	40	1	18	0	0	-10	10	50	51	72	
PN4861	TO-92	30	1	1	15	-10	0.8	8	15	60	1	18	0	0	-10	8	0	100	51	72
T1573	TO-92	30	1	2	15	-10	4	50	15	25	1	18	0	0	-10	9	25	51	77	
T1574	TO-92	30	1	2	15	-10	2	20	15	40	1	18	0	0	-10	8	0	100	51	77
T1575	TO-92	30	1	2	15	-10	0.8	8	15	60	1	18	0	0	-10	20	100	51	77	
U1897E	TO-92	40	1	0.2*	20	-10	5	30	20	30	1	16	20	0	0	25	40	51	72	
U1898E	TO-92	40	1	0.2*	20	-10	2	15	20	50	1	16	20	0	0	35	60	51	72	
U1899E	TO-92	40	1	0.2*	20	-10	1	8	20	80	1	16	20	0	0	60	80	51	72	





## N-Channel FETs

### RF, VHF, UHF AMPLIFIERS

Type No.	Case Style	BV <sub>GSS</sub> (V) @ I <sub>G</sub> (μA)	I <sub>DGO</sub> (μA) @ V <sub>DG</sub> (V)	V <sub>p</sub> (V) @ V <sub>DS</sub> (V)	I <sub>D</sub> (nA)	I <sub>DSS</sub> (mA) @ V <sub>DS</sub> (V)	R <sub>θj-c</sub> (mmho) @ Freq (MHz)	R <sub>θj-c</sub> (μmho) @ f (MHz)	C <sub>iss</sub> (pF) @ V <sub>DS</sub> (V)	V <sub>GS</sub> (V)	C <sub>rss</sub> (pF) @ V <sub>DS</sub> (V)	V <sub>GS</sub> (V)	NF (dB) @ R <sub>GS</sub> = 1k Freq (MHz)	Process No.	Pkg. No.
2N3819	TO-92	25	1	2	15	2	1.6	100	8	15	0	0	50	50	74
2N3823	TO-72	30	1	8	15	4	3.2	200	6	15	0	0	2.5	50	25
2N4223	TO-72	30	10	0.1	8	3	2.7	200	6	15	0	0	5	50	25
2N4224	TO-72	30	10	0.1	8	2	1.7	200	6	15	0	0	2	50	25
2N4416	TO-72	30	1	6	15	1	4	400	4	15	0	0	4	50	25
*2N4416A	TO-72	35	1	0.1	20	5	4	400	4	15	0	0	4	50	25
2N5078	TO-72	30	1	0.25	20	4	4	200	6	15	0	0	3	50	25
2N5245	TO-92	30	1	1	20	1	4	100	4.5	15	0	0	4	90	77
2N5246	TO-92	30	1	1	20	1.5	2.5	400	4.5	15	0	0	4	90	77
2N5247	TO-92	30	1	1	20	1.5	4	400	4.5	15	0	0	4	90	77
2N5248	TO-92	30	1	5	20	1	3	200	6	15	0	0	2	50	74
2N5397	TO-72	25	1	0.1	15	1	5.5	450	5	10	10	10m	3.5	450	90
2N5398	TO-72	25	1	0.1	15	1	5.0	450	5.5	10	10	10	3.2	450	90
2N5484	TO-92	25	1	0.3	3	1	2.5	100	5	15	0	0	3	100	50
2N5485	TO-92	25	1	1	4	10	3	400	5	15	0	0	4	400	50
2N5486	TO-92	25	1	2	6	8	3.5	400	5	15	0	0	4	400	50
2N5668	TO-92	25	10	2	15	0.2	1	100	7	15	0	0	2.5	100	50
2N5669	TO-92	25	10	2	15	1	1.6	100	7	15	0	0	2.5	100	50
2N5670	TO-92	25	10	2	8	15	2.5	100	7	15	0	0	2.5	100	50
2N5949	TO-92	30	1	15	3	7	3.0	100	6	15	0	0	5	100	50
2N5950	TO-92	30	1	15	2.5	6	3.0	100	6	15	0	0	5	100	50
2N5951	TO-92	30	1	15	2	5	3.0	100	6	15	0	0	5	100	50
2N5952	TO-92	30	1	15	1.3	3.5	1.0	100	6	15	0	0	5	100	50
2N5953	TO-92	30	1	15	2	3	1.0	100	6	15	0	0	5	100	50
J300	TO-92	25	1	0.5	15	1	4.5	001	5.5	10	5m	10	12	100	90
J304	TO-92	30	1	0.1	20	2	14.2	400	13	15	0	0	14	400	50
J305	TO-92	30	1	0.1	20	5	8	400	13	15	0	0	14	400	50
J308	TO-92	25	1	1	15	1	8	001	13	15	0	0	14	400	50
J309	TO-92	25	1	1	15	1	8	001	13	15	0	0	14	400	50
J310	TO-92	25	1	1	15	1	8	001	13	15	0	0	14	400	50
J311	TO-92	25	1	1	15	1	8	001	13	15	0	0	14	400	50
J312	TO-92	25	1	1	15	1	8	001	13	15	0	0	14	400	50
J313	TO-92	25	1	1	15	1	8	001	13	15	0	0	14	400	50
J314	TO-92	25	1	1	15	1	8	001	13	15	0	0	14	400	50
J315	TO-92	25	1	1	15	1	8	001	13	15	0	0	14	400	50
J316	TO-92	25	1	1	15	1	8	001	13	15	0	0	14	400	50
J317	TO-92	25	1	1	15	1	8	001	13	15	0	0	14	400	50
J318	TO-92	25	1	1	15	1	8	001	13	15	0	0	14	400	50
J319	TO-92	25	1	1	15	1	8	001	13	15	0	0	14	400	50
J320	TO-92	25	1	1	15	1	8	001	13	15	0	0	14	400	50
J321	TO-92	25	1	1	15	1	8	001	13	15	0	0	14	400	50
J322	TO-92	25	1	1	15	1	8	001	13	15	0	0	14	400	50
J323	TO-92	25	1	1	15	1	8	001	13	15	0	0	14	400	50
J324	TO-92	25	1	1	15	1	8	001	13	15	0	0	14	400	50
J325	TO-92	25	1	1	15	1	8	001	13	15	0	0	14	400	50
J326	TO-92	25	1	1	15	1	8	001	13	15	0	0	14	400	50
J327	TO-92	25	1	1	15	1	8	001	13	15	0	0	14	400	50
J328	TO-92	25	1	1	15	1	8	001	13	15	0	0	14	400	50
J329	TO-92	25	1	1	15	1	8	001	13	15	0	0	14	400	50
J330	TO-92	25	1	1	15	1	8	001	13	15	0	0	14	400	50
J331	TO-92	25	1	1	15	1	8	001	13	15	0	0	14	400	50
J332	TO-92	25	1	1	15	1	8	001	13	15	0	0	14	400	50
J333	TO-92	25	1	1	15	1	8	001	13	15	0	0	14	400	50
J334	TO-92	25	1	1	15	1	8	001	13	15	0	0	14	400	50
J335	TO-92	25	1	1	15	1	8	001	13	15	0	0	14	400	50
J336	TO-92	25	1	1	15	1	8	001	13	15	0	0	14	400	50
J337	TO-92	25	1	1	15	1	8	001	13	15	0	0	14	400	50
J338	TO-92	25	1	1	15	1	8	001	13	15	0	0	14	400	50
J339	TO-92	25	1	1	15	1	8	001	13	15	0	0	14	400	50
J340	TO-92	25	1	1	15	1	8	001	13	15	0	0	14	400	50
J341	TO-92	25	1	1	15	1	8	001	13	15	0	0	14	400	50
J342	TO-92	25	1	1	15	1	8	001	13	15	0	0	14	400	50
J343	TO-92	25	1	1	15	1	8	001	13	15	0	0	14	400	50
J344	TO-92	25	1	1	15	1	8	001	13	15	0	0	14	400	50
J345	TO-92	25	1	1	15	1	8	001	13	15	0	0	14	400	50
J346	TO-92	25	1	1	15	1	8	001	13	15	0	0	14	400	50
J347	TO-92	25	1	1	15	1	8	001	13	15	0	0	14	400	50
J348	TO-92	25	1	1	15	1	8	001	13	15	0	0	14	400	50
J349	TO-92	25	1	1	15	1	8	001	13	15	0	0	14	400	50
J350	TO-92	25	1	1	15	1	8	001	13	15	0	0	14	400	50
J351	TO-92	25	1	1	15	1	8	001	13	15	0	0	14	400	50
J352	TO-92	25	1	1	15	1	8	001	13	15	0	0	14	400	50
J353	TO-92	25	1	1	15	1	8	001	13	15	0	0	14	400	50
J354	TO-92	25	1	1	15	1	8	001	13	15	0	0	14	400	50
J355	TO-92	25	1	1	15	1	8	001	13	15	0	0	14	400	50
J356	TO-92	25	1	1	15	1	8	001	13	15	0	0	14	400	50
J357	TO-92	25	1	1	15	1	8	001	13	15	0	0	14	400	50
J358	TO-92	25	1	1	15	1	8	001	13	15	0	0	14	400	50
J359	TO-92	25	1	1	15	1	8	001	13	15	0	0	14	400	50
J360	TO-92	25	1	1	15	1	8	001	13	15	0	0	14	400	50
J361	TO-92	25	1	1	15	1	8	001	13	15	0	0	14	400	50
J362	TO-92	25	1	1	15	1	8	001	13	15	0	0	14	400	50
J363	TO-92	25	1	1	15	1	8	001	13	15	0	0	14	400	50
J364	TO-92	25	1	1	15	1	8	001	13	15	0	0	14	400	50
J365	TO-92	25	1	1	15	1	8	001	13	15	0	0	14	400	50
J366	TO-92	25	1	1	15	1	8	001	13	15	0	0	14	400	50
J367	TO-92	25	1	1	15	1	8	001	13	15	0	0	14	400	50
J368	TO-92	25	1	1	15	1	8	001	13	15	0	0	14	400	50
J369	TO-92	25	1	1	15	1	8	001	13	15	0	0	14	400	50
J370	TO-92	25	1	1	15	1	8	001	13	15	0	0	14	400	50
J371	TO-92	25	1	1	15	1	8	001	13	15	0	0	14	400	50
J372	TO-92	25	1	1	15	1	8	001	13	15	0	0	14	400	50
J373	TO-92	25	1	1	15	1	8	001	13	15	0	0	14	400	50
J374	TO-92	25	1	1	15	1	8	001	13	15	0	0	14	400	50
J375	TO-92	25	1	1	15	1	8	001	13	15	0	0	14	400	50
J376	TO-92	25	1	1	15	1	8	001	13	15	0	0	14	400	50
J377	TO-92	25	1	1	15	1	8	001	13	15	0	0	14	400	50
J378	TO-92	25	1	1	15	1	8	001	13	15	0	0	14	400	50
J379	TO-92	25	1	1	15	1	8	001	13	15	0	0	14	400	50
J380	TO-92	25	1	1	15	1	8	001	13	15	0	0	14	400	50
J381	TO-92	25	1	1	15	1	8	001							





## N-Channel FETs

### ULTRA LOW INPUT CURRENT AMPS

Transistor Type	Case Style	BV <sub>GSS</sub> (V) @ I <sub>G</sub> (μA) Min	BV <sub>GDO</sub> (V) @ I <sub>G</sub> (μA) Max	I <sub>GSS</sub> (pA) @ V <sub>DG</sub> (V) Max	V <sub>p</sub> (V) @ V <sub>DS</sub> (V) Min Max	I <sub>D</sub> (nA) @ V <sub>DS</sub> (V) Min Max	I <sub>DSS</sub> (μA) @ V <sub>DS</sub> (V) Min Max	G <sub>fs</sub> (μmho) @ V <sub>DS</sub> (V) Min Max	G <sub>oss</sub> (μmho) @ V <sub>DS</sub> (V) Max	C <sub>iss</sub> (pF) @ V <sub>DS</sub> (V) Max	V <sub>GS</sub> (V) @ V <sub>DS</sub> (V) Max	C <sub>rss</sub> (pF) @ V <sub>DS</sub> (V) Max	V <sub>GS</sub> (V) @ f (Hz) Max	Process No.	Pkg. No.	
2N4117	TO-72	40	1	10	20	0.6	1.8	10	3	10	0	1.5	10	0	53	25
2N4117A	TO-72	40	1	1	20	0.6	1.8	10	3	10	0	1.5	10	0	53	25
2N4118	TO-72	40	1	10	20	1	3	10	5	10	0	1.5	10	0	53	25
2N4118A	TO-72	40	1	1	20	1	3	10	5	10	0	1.5	10	0	53	25
2N4119	TO-72	40	1	10	20	2	6	10	10	10	0	1.5	10	0	53	25
2N4119A	TO-72	40	1	1	20	2	6	10	10	10	0	1.5	10	0	53	25



## N-Channel FETs

### GENERAL PURPOSE AMPS

Transistor Type	Case Style	BV <sub>GSS</sub> (V) @ I <sub>G</sub> (μA) Min	BV <sub>GDO</sub> (V) @ I <sub>G</sub> (μA) Max	I <sub>GSS</sub> (nA) @ V <sub>DG</sub> (V) Max	V <sub>p</sub> (V) @ V <sub>DS</sub> (V) Min Max	I <sub>D</sub> (nA) @ V <sub>DS</sub> (V) Min Max	I <sub>DSS</sub> (mA) @ V <sub>DS</sub> (V) Min Max	G <sub>fs</sub> (mmho) @ V <sub>DS</sub> (V) Min Max	G <sub>oss</sub> (μmho) @ V <sub>DS</sub> (V) Max	C <sub>iss</sub> (pF) @ V <sub>DS</sub> (V) Max	V <sub>GS</sub> (V) @ V <sub>DS</sub> (V) Max	C <sub>rss</sub> (pF) @ V <sub>DS</sub> (V) Max	V <sub>GS</sub> (V) @ f (Hz) Max	Process No.	Pkg. No.	
2N3069	TO-18	*50	1	1	30	9.5	30	1000	2	10	30	15	0	125	1000	52
2N3070	TO-18	*50	1	30	30	4.5	30	1000	0.5	2.5	30	15	0	125	1000	52
2N3368	TO-18	*40	1	5	30	11.5	20	1000	2	12	30	20	8	0	3	52
2N3369	TO-18	*40	1	5	30	6.5	20	1000	0.5	2.5	30	20	8	0	3	52
2N3370	TO-18	*40	1	5	30	3.2	20	1000	0.1	0.6	30	20	8	0	3	52
2N3436	TO-18	*50	1	0.5	30	9.8	20	1000	3	15	20	2.5	10	0	-10	6
2N3437	TO-18	*50	1	0.5	30	4.8	20	1000	0.8	4	20	1.5	6	0	-6	30
2N3438	TO-18	*50	1	0.5	30	2.3	20	1000	0.2	1	20	0.8	4.5	0	-4	6
2N3468	TO-18	*50	1	0.25	30	7.8	20	1000	3	15	20	2.5	10	0	-10	5
2N3469	TO-18	*50	1	0.25	30	3.4	20	1000	0.8	4	20	1.5	6	0	-6	5
2N3469A	TO-18	*50	1	0.25	30	1.8	20	1000	0.2	1	20	0.8	4.5	0	-4	5
2N3684	TO-72	50	1	0.1	30	2	5	20	1	2.5	20	4	20	0	1.2	20
2N3685	TO-72	50	1	0.1	30	1	3.5	20	1	3	20	4	20	0	1.2	20
2N3686	TO-72	50	1	0.1	30	0.6	2	20	1	0.4	1.2	20	4	20	0	1.2
2N3687	TO-72	50	1	0.1	30	0.3	1.2	20	0.1	0.5	20	4	20	0	1.2	20
2N3821	TO-72	50	1	0.1	30	4	15	5	0.5	2.5	15	15	0	200	10	55
2N3822	TO-72	50	1	0.1	30	6	15	5	2	10	15	6	15	0	200	10
2N3967	TO-72	30	1	0.1	20	2	5	20	1	2.5	10	20	20	0	84	100
2N3967A	TO-72	30	1	0.1	20	2	5	20	1	2.5	10	20	20	0	84	100
2N3968	TO-72	30	1	0.1	20	3	20	1	1	5	20	5	20	0	84	100
2N3968A	TO-72	30	1	0.1	20	3	20	1	1	5	20	5	20	0	84	100
2N3969	TO-72	30	1	0.1	20	1.7	20	1	0.4	2	20	5	20	0	84	100
2N3969A	TO-72	30	1	0.1	20	1.7	20	1	0.4	2	20	5	20	0	84	100

† I<sub>D</sub> = 1 mA    † I<sub>D</sub> = 500 μA    † I<sub>D</sub> = 250 μA    † I<sub>D</sub> = 100 μA    †† I<sub>D</sub> = 40 μA



# N-Channel FETs

## GENERAL PURPOSE AMPS (Continued)

Transistor Type	Case Style	BV <sub>GSD</sub> (V) @ I <sub>G</sub> (μA)		I <sub>GSS</sub> (nA) @ V <sub>DG</sub> (V)		V <sub>p</sub> (V) @ V <sub>DS</sub> (V)		I <sub>D</sub> (mA)		I <sub>DSS</sub> (mA) @ V <sub>DS</sub> (V)		G <sub>fs</sub> (mmhol) @ V <sub>DS</sub> (V)		G <sub>oss</sub> (μmho) @ V <sub>DS</sub> (V)		C <sub>iss</sub> (pF) @ V <sub>DS</sub> (V)		V <sub>GS</sub> (V)		ρ(F) @ V <sub>GS</sub> (V)		C <sub>rss</sub> (pF) @ V <sub>DS</sub> (V)		V <sub>GS</sub> (V)		e <sub>n</sub> (nV/√Hz) @ Freq (Hz)		Process No.		Pkg. No.	
		Min	Max	Min	Max	Min	Max	Min	Max	Min	Max	Min	Max	Min	Max	Min	Max	Min	Max	Min	Max	Min	Max	Min	Max	Min	Max	Min	Max	Min	Max
2N4220	TO-72	30	10	0.1	15	4	15	1	0.5	3	15	1	4	15	10	15	6	15	0	15	0	2	15	0	15	0	115	100	55	25	
2N4220A	TO-72	30	10	0.1	15	4	15	1	0.5	3	15	1	4	15	10	15	6	15	0	15	0	2	15	0	15	0	115	100	55	25	
2N4221	TO-72	30	10	0.1	15	6	15	1	2	6	15	2	5	15	20	15	6	15	0	15	0	2	15	0	15	0	115	100	55	25	
2N4221A	TO-72	30	10	0.1	15	6	15	1	2	6	15	2	5	15	20	15	6	15	0	15	0	2	15	0	15	0	115	100	55	25	
2N4222	TO-72	30	10	0.1	15	8	15	1	5	15	15	2.5	6	15	40	15	6	15	0	15	0	2	15	0	15	0	115	100	55	25	
2N4222A	TO-72	30	10	0.1	15	8	15	1	5	15	15	2.5	6	15	40	15	6	15	0	15	0	2	15	0	15	0	115	100	55	25	
2N4338	TO-18	50	1	0.1	30	0.3	1	15	100	0.2	0.6	15	0.6	1.8	15	5	15	7	15	0	3	15	0	3	15	0	68	1000	52	02	
2N4339	TO-18	50	1	0.1	30	0.6	1	15	100	0.5	1.5	15	0.8	2.4	15	15	15	7	15	0	3	15	0	3	15	0	68	1000	52	02	
2N4340	TO-18	50	1	0.1	30	1	3	15	100	1.2	3.6	15	1.3	3	15	30	15	7	15	0	3	15	0	3	15	0	68	1000	52	02	
2N4341	TO-18	50	1	0.1	30	2	6	15	100	3	9	15	2	4	15	60	15	7	15	0	3	15	0	3	15	0	68	1000	55	02	
2N5103	TO-72	25	10	0.1	15	0.5	4	15	1	8	15	2	8	15	100	15	5	15	0	1	15	0	1	15	0	100	10	50	25		
2N5104	TO-72	25	10	0.1	15	0.5	4	15	1	2	6	15	3.5	7.5	15	100	15	5	15	0	1	15	0	1	15	0	50	10	50	25	
2N5105	TO-72	25	10	0.1	15	0.5	4	15	1	5	15	5	10	15	100	15	5	15	0	1	15	0	1	15	0	50	10	50	25		
2N5358	TO-72	40	1	0.1	20	0.5	3	15	100	0.5	1	15	1	3	15	10	15	6	15	0	2	15	0	2	15	0	115	100	55	25	
2N5359	TO-72	40	1	0.1	20	0.8	4	15	100	0.6	1.6	15	1.2	3.6	15	10	15	6	15	0	2	15	0	2	15	0	115	100	55	25	
2N5360	TO-72	40	1	0.1	20	0.8	4	15	100	0.5	2.5	15	1.4	4.2	15	20	15	6	15	0	2	15	0	2	15	0	115	100	55	25	
2N5361	TO-72	40	1	0.1	20	1	6	15	100	2.5	5	15	1.5	4.5	15	20	15	6	15	0	2	15	0	2	15	0	115	100	55	25	
2N5362	TO-72	40	1	0.1	20	2	7	15	100	4	8	15	2	5.5	15	40	15	6	15	0	2	15	0	2	15	0	115	100	55	25	
2N5363	TO-72	40	1	0.1	20	2.5	8	15	100	7	14	15	2.5	6	15	40	15	6	15	0	2	15	0	2	15	0	115	100	55	25	
2N5364	TO-72	40	1	0.1	20	2.5	8	15	100	9	18	15	2.7	6.5	15	60	15	6	15	0	2	15	0	2	15	0	115	100	55	25	
2N5457	TO-92	25	1	1	15	0.5	6	15	10	1	5	15	2	5	15	50	15	7	15	0	3	15	0	3	15	0	115	100	55	72	
2N5458	TO-92	25	1	1	15	1	7	15	10	2	9	15	1.5	5.5	15	50	15	7	15	0	3	15	0	3	15	0	115	100	55	72	
2N5459	TO-92	25	1	1	15	2	8	15	10	4	16	15	2	6	15	50	15	7	15	0	3	15	0	3	15	0	115	100	55	72	
2N5556	TO-72	30	1	0.1	15	0.2	4	15	1	0.5	2.5	15	1.5	6.5	15	20	15	6	15	0	3	15	0	3	15	0	35	10	50	25	
2N5557	TO-72	30	1	0.1	15	0.8	5	15	1	2.0	5.0	15	1.5	6.5	15	20	15	6	15	0	3	15	0	3	15	0	35	10	50	25	
2N5558	TO-72	30	1	0.1	15	1.5	6	15	1	4	10	15	1.5	6.5	15	20	15	6	15	0	3	15	0	3	15	0	35	10	50	25	
J201	TO-92	40	1	0.1	20	0.3	1.5	20	10	0.2	1.0	20	0.5	20	11	20	15	20	0	12	20	0	12	20	0	110	1k	52	72		
J202	TO-92	40	1	0.1	20	0.8	4.0	20	10	0.9	4.5	20	1.0	20	13.5	20	15	20	0	12	20	0	12	20	0	110	1k	52	72		
J203	TO-92	40	1	0.1	20	2.0	10.0	20	10	4.0	20	1.5	20	20	110	20	15	20	0	12	20	0	12	20	0	110	1k	52	72		
J210	TO-92	25	1	0.1	15	1	3	15	1	2	15	4.0	12.0	15	150	15	15	15	0	11.5	15	0	11.5	15	0	110	1k	90	72		
J211	TO-92	25	1	0.1	15	2.5	4.5	15	1	7	20	15	7.0	12.0	15	200	15	15	0	11.5	15	0	11.5	15	0	110	1k	90	72		
J212	TO-92	25	1	0.1	15	4	6	15	1	15	40	15	7.0	12.0	15	200	15	15	0	11.5	15	0	11.5	15	0	110	1k	90	72		
MPF 103	TO-92	25	1	1	15	6	15	1	1	5	15	1	5	15	50	15	7	15	0	3	15	0	3	15	0	35	10	55	72		
MPF 104	TO-92	25	1	1	15	7	15	1	2	9	15	1.5	5.5	15	50	15	7	15	0	3	15	0	3	15	0	35	10	55	72		
MPF 105	TO-92	25	1	1	15	8	15	1	4	16	15	2	6	15	50	15	7	15	0	3	15	0	3	15	0	35	10	55	72		
MPF 109	TO-92	25	10	1	15	0.2	8	15	10	0.5	24	15	0.8	6	15	75	15	7	15	0	3	15	0	3	15	0	115	1000	55	72	

N-Channel FETs

GENERAL PURPOSE AMPS (Continued)

Transistor Type	Case Style	BV <sub>GSS</sub> BV <sub>GDO</sub> (V) @ I <sub>G</sub> ( $\mu$ A)		IGSS I <sub>GDO</sub> (nA) @ V <sub>DG</sub> (V)		V <sub>p</sub> @ V <sub>DG</sub> (V)		I <sub>DSS</sub> @ V <sub>DG</sub> (mA)		G <sub>fs</sub> @ V <sub>DG</sub> (mmho)		G <sub>oss</sub> @ V <sub>DG</sub> ( $\mu$ mho)		C <sub>iss</sub> (pF) @ V <sub>DG</sub> (V)		V <sub>GS</sub> (V)		I <sub>DF</sub> Max (pF)		C <sub>rss</sub> V <sub>DS</sub> (V)		e <sub>n</sub> (nV/ $\sqrt$ Hz) @ Freq (Hz)		Process No.		Pkg. No.				
		Min	Max	Min	Max	Min	Max	Min	Max	Min	Max	Min	Max	Min	Max	Min	Max	Min	Max	Min	Max	Min	Max	Min	Max	Min	Max	Min	Max	
MPF111	TO-92	20	10	100	10	0.5	10	10	1000	0.5	20	10	200	10											50	72				
MPF112	TO-92	25	10	100	10	0.5	10	1000	1	25	10													55	72					
PN3684	TO-92	50	1	30	2	5	20	1	2.5	7.5	30	50	20	4	20	0	1.2	20	0	150	20	52	72							
PN3685	TO-92	50	1	30	1	3.5	20	1	3	20	1.5	25	20	4	20	0	1.2	20	0	150	20	52	72							
PN3686	TO-92	50	1	30	0.6	2	20	1	0.4	1.2	20	10	20	4	20	0	1.2	20	0	150	20	52	72							
PN3687	TO-92	50	1	30	0.3	1.2	20	1	0.1	0.5	20	5	20	4	20	0	1.2	20	0	150	20	52	72							
PN4220	TO-92	30	10	1	15	4	15	1	0.5	3	15	10	15	6	15	0	2	15	0					55	72					
PN4221	TO-92	30	10	1	15	6	15	1	2	6	15	20	15	6	15	0	2	15	0					55	72					
PN4222	TO-92	30	10	1	15	8	15	1	5	15	15	40	15	6	15	0	2	15	0					55	72					
PN4302	TO-92	30	1	1	10	4	20	10	0.5	5	20	50	20	6	20	0	3	20	0	100	1000	52	72							
PN4303	TO-92	30	1	1	10	6	20	10	4	10	20	50	20	6	20	0	3	20	0	100	1000	52	72							
PN4304	TO-92	30	1	1	10	10	20	10	0.5	15	20	50	20	6	20	0	3	20	0	100	1000	52	72							
PN5163	TO-92	25	1	10	15	0.4	8	15	1000	1	40	15	200	15	12	15	0	3	20	0	50	1000	50	74						
T1S58	TO-92	25	1	4	15	0.5	5	15	20	2.5	8	15	1.3	4	15	2	mA	3	15	2	mA	3	15	2	mA	50	74			
T1S59	TO-92	25	1	4	15	1	9	15	20	6	25	15	1.3	15	6	15	2	mA	3	15	2	mA	3	15	2	mA	50	74		

N-Channel FETs

GENERAL PURPOSE DUAL JFETs

Type No.	Case Style	OPERATING CONDITIONS FOR THESE CHARACTERISTICS										V <sub>p</sub>		I <sub>DSS</sub>		G <sub>fs</sub>		G <sub>oss</sub>		C <sub>iss</sub>		BV		e <sub>n</sub>		I <sub>DSS</sub>		G <sub>fs</sub>		I <sub>G1-I<sub>G2</sub></sub>		Process No.					
		V <sub>GS1,2</sub> V <sub>GS</sub> (V)	V <sub>DS</sub> V <sub>GS</sub> (V)	I <sub>D</sub> (mA)	V <sub>GS</sub> (V)	I <sub>G</sub> ( $\mu$ A)	IGSS ( $\mu$ mho)	CMRR (dB)	G <sub>oss</sub> ( $\mu$ mho)	V <sub>p</sub> (V)	I <sub>DSS</sub> (mA)	G <sub>fs</sub> (mmho)	G <sub>oss</sub> ( $\mu$ mho)	V <sub>p</sub> (V)	I <sub>DSS</sub> ( $\mu$ A)	G <sub>fs</sub> (mmho)	G <sub>oss</sub> ( $\mu$ mho)	C <sub>iss</sub> (pF)	C <sub>oss</sub> (pF)	BV (V)	e <sub>n</sub> (nV/ $\sqrt$ Hz)	f (Hz)	I <sub>DSS</sub> Match	G <sub>fs</sub> Match	I <sub>G1-I<sub>G2</sub></sub> (nA)	Process No.	Pkg. No.										
2N3921	TO-71	10	700	5.0	10	250	1500	20	-3.0	1.0	10	1.5	7.5	35	1000	30	18	6.0	50	100	1.0k	5.0	5.0		83	12											
2N3922	TO-71	10	700	5.0	25	250	1500	20	-3.0	1.0	10	1.5	7.5	35	1000	30	18	6.0	50	100	1.0k	5.0	5.0		83	12											
2N3934	TO-71	10	200	5.0	10	100	300	5.0	See 2N3954.6 as an improved replacement																												
2N3935	TO-71	10	200	5.0	25	100	300	5.0	See 2N3954.6 as an improved replacement																												
2N3954A	TO-71	20	200	5.0	5.0	50			1.0	4.5	5.0	1.0	3.0	35	130	30	4.0	1.2	50	150	100	1.0k	5.0	3.0	10	83	12										
2N3954	TO-71	20	200	5.0	10	50			1.0	4.5	5.0	1.0	3.0	35	130	30	4.0	1.2	50	150	100	1.0k	5.0	3.0	10	83	12										
2N3955A	TO-71	20	200	5.0	15	50			1.0	4.5	5.0	1.0	3.0	35	130	30	4.0	1.2	50	150	100	1.0k	5.0	3.0	10	83	12										
2N3955	TO-71	20	200	10	25	50			1.0	4.5	5.0	1.0	3.0	35	130	30	4.0	1.2	50	150	100	1.0k	5.0	3.0	10	83	12										
2N3956	TO-71	20	200	15	50	50			1.0	4.5	5.0	1.0	3.0	35	130	30	4.0	1.2	50	150	100	1.0k	5.0	3.0	10	83	12										
2N3957	TO-71	20	200	20	75	50			1.0	4.5	5.0	1.0	3.0	35	130	30	4.0	1.2	50	150	100	1.0k	5.0	3.0	10	83	12										
2N3958	TO-71	20	200	35	100	50			1.0	4.5	5.0	1.0	3.0	35	130	30	4.0	1.2	50	150	100	1.0k	5.0	3.0	10	83	12										
2N4082	TO-71	10	200	15	10	100	300	10	See 2N3954.6 as an improved replacement																												
2N4083	TO-71	10	200	15	25	100	300	10	See 2N3954.6 as an improved replacement																												
2N4084	TO-71	10	700	15	10	250	1500	20	3.0	1.0	10	1.5	7.5	35	1000	30	18	6.0	50	100	1.0k	5.0	5.0		83	12											
2N4085	TO-71	10	700	15	25	250	1500	20	3.0	1.0	10	1.5	7.5	35	1000	30	18	6.0	50	100	1.0k	5.0	5.0		83	12											



# N-Channel FETS

## GENERAL PURPOSE DUAL JFETs (Continued)

Type No.	Case Style	OPERATING CONDITIONS FOR THESE CHARACTERISTICS										Process No.																			
		OP. CHAR. V <sub>GS</sub> (V)	I <sub>D</sub> (μA)	V <sub>GS1-2</sub> (V)	V <sub>GS</sub> (V)	DRIFT (μV/°C)	I <sub>C</sub> (μA)	G <sub>fs</sub> (μmhos)	G <sub>fs</sub> (μmho)	CMRR (dB)	V <sub>GS</sub> (V)		V <sub>GS</sub> (V)	I <sub>DSS</sub> (mA)	G <sub>fs</sub> (mhmho)	I <sub>DSS</sub> (μA) @ V <sub>GS</sub> (V)	C <sub>iss</sub> (pF)	C <sub>iss</sub> (pF)	BV (V)	f <sub>T</sub> (MHz)	I <sub>DSS</sub> Match %	G <sub>fs</sub> Match %	G <sub>fs1-2</sub> (μmho)	I <sub>G1-I2</sub> (nA)	Pkg. No.						
2N5045	TO-71	15	200	5.0	67						0.5	4.5	0.5	8.0	1.5	6.0	25	250	30	8.0	4.0	50	200	10	10	5.0	1.0	83	12		
2N5046	TO-71	15	200	10	133						0.5	4.5	0.5	8.0	1.5	6.0	25	250	30	8.0	4.0	50	200	10	10	2.0	3.0	83	12		
2N5047	TO-71	15	200	15	200						0.5	4.5	0.5	8.0	1.5	6.0	25	250	30	8.0	4.0	50	200	10	10	2.0	3.0	83	12		
2N5196	TO-71	20	200	5.0	5.0	15	700	1500	4.0	0.2	3.8	0.7	4.5	0.7	7.0	1.0	4.0	50	25	30	6.0	2.0	50	20	1.0k	3.0	1.0	5.0	83	12	
2N5197	TO-71	20	200	5.0	10	15	700	1500	4.0	0.2	3.8	0.7	4.5	0.7	7.0	1.0	4.0	50	25	30	6.0	2.0	50	20	1.0k	3.0	1.0	5.0	83	12	
2N5198	TO-71	20	200	10	20	15	700	1500	4.0	0.2	3.8	0.7	4.5	0.7	7.0	1.0	4.0	50	25	30	6.0	2.0	50	20	1.0k	3.0	1.0	5.0	83	12	
2N5199	TO-71	20	200	15	40	15	700	1500	4.0	0.2	3.8	0.7	4.5	0.7	7.0	1.0	4.0	50	25	30	6.0	2.0	50	20	1.0k	3.0	1.0	5.0	83	12	
2N5452	TO-71	20	200	5.0	5.0	10	1.0	0.2	4.2	1.0	4.5	0.5	5.0	1.0	3.0	3.0	100	30	4.0	1.2	50	20	1.0k	5.0	3.0	0.25	83	12			
2N5453	TO-71	20	200	10	10	10	1.0	0.2	4.2	1.0	4.5	0.5	5.0	1.0	3.0	3.0	100	30	4.0	1.2	50	20	1.0k	5.0	3.0	0.25	83	12			
2N5454	TO-71	20	200	15	25		1.0	0.2	4.2	1.0	4.5	0.5	5.0	1.0	3.0	3.0	100	30	4.0	1.2	50	20	1.0k	5.0	3.0	0.25	83	12			
2N5545	TO-71	15	200	5.0	10	50					0.5	4.5	0.5	8.0	1.5	6.0	25	100	30	6.0	2.0	50	180	10	5.0	3.0	1.0	5.0	83	12	
2N5546	TO-71	15	200	10	20	50					0.5	4.5	0.5	8.0	1.5	6.0	25	100	30	6.0	2.0	50	200	10	5.0	3.0	2.0	5.0	83	12	
2N5547	TO-71	15	200	15	40	50					0.5	4.5	0.5	8.0	1.5	6.0	25	100	30	6.0	2.0	50	200	10	5.0	3.0	3.0	5.0	83	12	
2N5551	TO-71																														
2N5562	TO-71																														
2N5563	TO-71																														
J401	8-Pin																														
J402	J403	J404	J405	J406																											
2N3954	8-Pin	20	200	10	10	250	600	1200	5.0	0.3	4.0	0.5	3.5	0.5	6	1	4	20	250	20	4.5	1.2	40	50	100	4.5	1.2	40	50	98	60
2N3955	8-Pin	20	200	25	25	250	600	1200	5.0	0.3	4.0	0.5	3.5	0.5	6	1	4	20	250	20	4.5	1.2	40	50	100	4.5	1.2	40	50	98	60
2N3956	8-Pin	20	200	40	80	250	600	1200	5.0	0.3	4.0	0.5	3.5	0.5	6	1	4	20	250	20	4.5	1.2	40	50	100	4.5	1.2	40	50	98	60
2N3957	8-Pin	20	200	5	10	100	700	1200	5.0	0.3	4.0	0.5	3.5	0.5	6	1	4	20	100	20	4.5	1.2	40	50	100	4.5	1.2	40	50	98	60
2N3958	8-Pin	20	200	10	15	100	700	1200	5.0	0.3	4.0	0.5	3.5	0.5	6	1	4	20	100	20	4.5	1.2	40	50	100	4.5	1.2	40	50	98	60
2N3959	8-Pin	20	200	15	25	100	700	1200	5.0	0.3	4.0	0.5	3.5	0.5	6	1	4	20	100	20	4.5	1.2	40	50	100	4.5	1.2	40	50	98	60
2N3960	8-Pin	20	200	25	25	100	700	1200	5.0	0.3	4.0	0.5	3.5	0.5	6	1	4	20	100	20	4.5	1.2	40	50	100	4.5	1.2	40	50	98	60
2N3961	8-Pin	20	200	10	10	50	600	1200	5.0	0.3	4.0	0.5	3.5	0.5	6	1	4	20	250	20	4.5	1.2	40	50	100	4.5	1.2	40	50	98	60
2N3962	8-Pin	20	200	10	10	50	600	1200	5.0	0.3	4.0	0.5	3.5	0.5	6	1	4	20	250	20	4.5	1.2	40	50	100	4.5	1.2	40	50	98	60
2N3963	8-Pin	20	200	10	10	50	600	1200	5.0	0.3	4.0	0.5	3.5	0.5	6	1	4	20	250	20	4.5	1.2	40	50	100	4.5	1.2	40	50	98	60
2N3964	8-Pin	20	200	10	10	50	600	1200	5.0	0.3	4.0	0.5	3.5	0.5	6	1	4	20	250	20	4.5	1.2	40	50	100	4.5	1.2	40	50	98	60
2N3965	8-Pin	20	200	10	10	50	600	1200	5.0	0.3	4.0	0.5	3.5	0.5	6	1	4	20	250	20	4.5	1.2	40	50	100	4.5	1.2	40	50	98	60
2N3966	8-Pin	20	200	10	10	50	600	1200	5.0	0.3	4.0	0.5	3.5	0.5	6	1	4	20	250	20	4.5	1.2	40	50	100	4.5	1.2	40	50	98	60
2N3967	8-Pin	20	200	10	10	50	600	1200	5.0	0.3	4.0	0.5	3.5	0.5	6	1	4	20	250	20	4.5	1.2	40	50	100	4.5	1.2	40	50	98	60
2N3968	8-Pin	20	200	10	10	50	600	1200	5.0	0.3	4.0	0.5	3.5	0.5	6	1	4	20	250	20	4.5	1.2	40	50	100	4.5	1.2	40	50	98	60
2N3969	8-Pin	20	200	10	10	50	600	1200	5.0	0.3	4.0	0.5	3.5	0.5	6	1	4	20	250	20	4.5	1.2	40	50	100	4.5	1.2	40	50	98	60
2N3970	8-Pin	20	200	10	10	50	600	1200	5.0	0.3	4.0	0.5	3.5	0.5	6	1	4	20	250	20	4.5	1.2	40	50	100	4.5	1.2	40	50	98	60
2N3971	8-Pin	20	200	10	10	50	600	1200	5.0	0.3	4.0	0.5	3.5	0.5	6	1	4	20	250	20	4.5	1.2	40	50	100	4.5	1.2	40	50	98	60
2N3972	8-Pin	20	200	10	10	50	600	1200	5.0	0.3	4.0	0.5	3.5	0.5	6	1	4	20	250	20	4.5	1.2	40	50	100	4.5	1.2	40	50	98	60
2N3973	8-Pin	20	200	10	10	50	600	1200	5.0	0.3	4.0	0.5	3.5	0.5	6	1	4	20	250	20	4.5	1.2	40	50	100	4.5	1.2	40	50	98	60
2N3974	8-Pin	20	200	10	10	50	600	1200	5.0	0.3	4.0	0.5	3.5	0.5	6	1	4	20	250	20	4.5	1.2	40	50	100	4.5	1.2	40	50	98	60
2N3975	8-Pin	20	200	10	10	50	600	1200	5.0	0.3	4.0	0.5	3.5	0.5	6	1	4	20	250	20	4.5	1.2	40	50	100	4.5	1.2	40	50	98	60
2N3976	8-Pin	20	200	10	10	50	600	1200	5.0	0.3	4.0	0.5	3.5	0.5	6	1	4	20	250	20	4.5	1.2	40	50	100	4.5	1.2	40	50	98	60
2N3977	8-Pin	20	200	10	10	50	600	1200	5.0	0.3	4.0	0.5	3.5	0.5	6	1	4	20	250	20	4.5	1.2	40	50	100	4.5	1.2	40	50	98	60
2N3978	8-Pin	20	200	10	10	50	600	1200	5.0	0.3	4.0	0.5	3.5	0.5	6	1	4	20	250	20	4.5	1.2	40	50	100	4.5	1.2	40	50	98	60
2N3979	8-Pin	20	200	10	10	50	600	1200	5.0	0.3	4.0	0.5	3.5	0.5	6	1	4	20	250	20	4.5	1.2	40	50	100	4.5	1.2	40	50	98	60
2N3980	8-Pin	20	200	10	10	50	600	1200	5.0	0.3	4.0																				



N-Channel FETs

LOW FREQUENCY—LOW NOISE DUAL JFETs

Type No.	Case Style	OPERATING CONDITIONS FOR THESE CHARACTERISTICS												Pkg. No.																
		OP. CHAR.		DRIFT		V <sub>GS1,2</sub> (V)	V <sub>GS</sub> (mV)	V <sub>GS</sub> (μV/°C)	I <sub>G</sub> (pA)	I <sub>G</sub> (ΔVGS)	G <sub>oss</sub> (μmho)	CMRR (dB)	V <sub>gs</sub> (V)		G <sub>ss</sub> (μmho)	I <sub>DSS</sub> (mA)	G <sub>fs</sub> (μmho)	I <sub>DSS</sub> (pA) @ V <sub>DG</sub>	C <sub>iss</sub> (pF)	BV (V)	e <sub>n</sub> (nV/√Hz) @ f	I <sub>DSS</sub> Match %	G <sub>fs</sub> Match %	G <sub>oss1,2</sub> (μmho)	I <sub>g1,2</sub> (nA)	Process No.				
		V <sub>DG</sub> (V)	I <sub>D</sub> (μA)	V <sub>GS1,2</sub> (mV)	V <sub>GS</sub> (μV)																						Min	Max	Min	Max
2N5515	TO-71	20	200	5.0	100	500	1000	1.0	100	0.2	3.8	0.7	4.0	0.5	7.5	1.0	4.0	10	250	30	+25	+5.0	40	10	5.0	3.0	0.1	10	95	12
2N5516	TO-71	20	200	5.0	100	500	1000	1.0	100	0.2	3.8	0.7	4.0	0.5	7.5	1.0	4.0	10	250	30	+25	+5.0	40	10	5.0	3.0	0.1	10	95	12
2N5517	TO-71	20	200	10	200	1000	1000	1.0	90	0.2	3.8	0.7	4.0	0.5	7.5	1.0	4.0	10	250	30	+25	+5.0	40	10	5.0	5.0	0.1	10	95	12
2N5518	TO-71	20	200	15	400	1000	1000	1.0	90	0.2	3.8	0.7	4.0	0.5	7.5	1.0	4.0	10	250	30	+25	+5.0	40	10	5.0	5.0	0.1	10	95	12
2N5519	TO-71	20	200	15	80	1000	1000	1.0	90	0.2	3.8	0.7	4.0	0.5	7.5	1.0	4.0	10	250	30	+25	+5.0	40	10	5.0	3.0	0.1	10	95	12
2N5520	TO-71	20	200	5.0	100	500	1000	1.0	100	0.2	3.8	0.7	4.0	0.5	7.5	1.0	4.0	10	250	30	+25	+5.0	40	10	5.0	3.0	0.1	10	95	12
2N5521	TO-71	20	200	5.0	100	500	1000	1.0	100	0.2	3.8	0.7	4.0	0.5	7.5	1.0	4.0	10	250	30	+25	+5.0	40	10	5.0	3.0	0.1	10	95	12
2N5522	TO-71	20	200	10	200	1000	1000	1.0	90	0.2	3.8	0.7	4.0	0.5	7.5	1.0	4.0	10	250	30	+25	+5.0	40	10	5.0	5.0	0.1	10	95	12
2N5523	TO-71	20	200	15	400	1000	1000	1.0	90	0.2	3.8	0.7	4.0	0.5	7.5	1.0	4.0	10	250	30	+25	+5.0	40	10	5.0	5.0	0.1	10	95	12
2N5524	TO-71	20	200	5.0	100	500	1000	1.0	100	0.2	3.8	0.7	4.0	0.5	7.5	1.0	4.0	10	250	30	+25	+5.0	40	10	5.0	3.0	0.1	10	95	12
2N5525	TO-71	20	200	5.0	100	500	1000	1.0	100	0.2	3.8	0.7	4.0	0.5	7.5	1.0	4.0	10	250	30	+25	+5.0	40	10	5.0	3.0	0.1	10	95	12
2N5526	TO-71	20	200	10	200	1000	1000	1.0	100	0.2	3.8	0.7	4.0	0.5	7.5	1.0	4.0	10	250	30	+25	+5.0	40	10	5.0	3.0	0.1	10	95	12
2N5527	TO-71	20	200	15	400	1000	1000	1.0	90	0.2	3.8	0.7	4.0	0.5	7.5	1.0	4.0	10	250	30	+25	+5.0	40	10	5.0	5.0	0.1	10	95	12



N-Channel FETs

WIDE BAND—LOW NOISE DUAL JFETs

Type No.	Case Style	OPERATING CONDITIONS FOR THESE CHARACTERISTICS												Pkg. No.															
		OP. CHAR.		DRIFT		V <sub>GS1,2</sub> (V)	V <sub>GS</sub> (mV)	V <sub>GS</sub> (μV/°C)	I <sub>G</sub> (pA)	I <sub>G</sub> (ΔVGS)	G <sub>oss</sub> (μmho)	CMRR (dB)	V <sub>gs</sub> (V)		G <sub>ss</sub> (μmho)	I <sub>DSS</sub> (mA)	G <sub>fs</sub> (μmho)	I <sub>DSS</sub> (pA) @ V <sub>DG</sub>	C <sub>iss</sub> (pF)	BV (V)	e <sub>n</sub> (nV/√Hz) @ f	I <sub>DSS</sub> Match %	G <sub>fs</sub> Match %	G <sub>oss1,2</sub> (μmho)	I <sub>g1,2</sub> (nA)	Process No.			
		V <sub>DG</sub> (V)	I <sub>D</sub> (μA)	V <sub>GS1,2</sub> (mV)	V <sub>GS</sub> (μV)																						Min	Max	Min
2N5564	TO-71	15	2000	5.0	10	10	10	45	1500	0.5	3.0	0.5	3.0	5.0	30	100	20	12	3.0	40	50	10	5.0	10	5.0	5.0	30	96	12
2N5565	TO-71	15	2000	10	20	20	20	45	7500	0.5	3.0	0.5	3.0	5.0	30	100	20	12	3.0	40	50	10	5.0	10	5.0	5.0	30	96	12
2N5566	TO-71	15	2000	20	50	50	50	45	7500	0.5	3.0	0.5	3.0	5.0	30	100	20	12	3.0	40	50	10	5.0	10	5.0	5.0	30	96	12
2N5911	TO-78	10	5000	10	20	100	1000	100	5000	1.0	5.0	1.0	5.0	7.0	40	100	15	5.0	1.2	25	20	10k	5.0	5.0	20	20	93	24	
2N5912	TO-78	10	5000	15	40	100	5000	100	5000	1.0	5.0	1.0	5.0	7.0	40	100	15	5.0	1.2	25	20	10k	5.0	5.0	20	20	93	24	
MPD5564	8Pin	15	2000	5.0	10	10	10	45	7500	0.5	3.0	0.5	3.0	5.0	30	100	20	12	3.0	40	50	10	5.0	10	5.0	5.0	30	96	67
MPD5565	8Pin	15	2000	10	20	20	20	45	7500	0.5	3.0	0.5	3.0	5.0	30	100	20	12	3.0	40	50	10	5.0	10	5.0	5.0	30	96	67
MPD5566	DIP	15	2000	20	50	50	50	45	7500	0.5	3.0	0.5	3.0	5.0	30	100	20	12	3.0	40	50	10	5.0	10	5.0	5.0	30	96	67
U257	TO-78	10	5000	100	100	100	100	150	5000	1.0	5.0	1.0	5.0	5.0	40	100	15	5.0	1.2	25	30	10k	15	15	20	93	24		
L430	TO-88	10	10,000	10	10	10	10	150	10,000	1.0	4.0	1.0	4.0	12	50	100	15	5.0	1.2	25	10	100	10	10	10	92	24		
U431	TO-88	10	10,000	10	10	10	10	150	10,000	2.0	6.0	2.0	6.0	24	50	100	15	5.0	1.2	25	10	100	10	10	10	92	24		





## P-Channel FETs

### SWITCHES

Transistor Type	Case Style	BV <sub>GSS</sub> BV <sub>GDO</sub> (V) @ I <sub>G</sub> Min	I <sub>GSS</sub> ID <sub>GDO</sub> (nA) @ V <sub>DG</sub> Max	I <sub>D(off)</sub> (nA) @ V <sub>DS</sub> Max	V <sub>P</sub> (V) Min Max	I <sub>D</sub> (μA) Min Max	I <sub>DSS</sub> (mA) @ V <sub>DS</sub> Min Max	V <sub>DS</sub> (V) Max	r <sub>DS</sub> (Ω) @ I <sub>D</sub> Max	C <sub>iss</sub> (pF) @ V <sub>DS</sub> Max	V <sub>GS</sub> (V) Max	C <sub>rss</sub> @ V <sub>DS</sub> (V) Max	V <sub>GS</sub> (V) Max	t <sub>on</sub> (ns) Max	t <sub>off</sub> (ns) Max	Process No.	Pkg. No.		
2N3382	TO-72	30	1	15	30	10	3	30	10	300						88	23		
2N3384	TO-72	30	1	15	30	10	15	30	10	180						88	23		
2N3386	TO-72	30	1	15	30	10	15	50	10	150						88	23		
2N3993	TO-72	25	1	1.2*	15	10	10	10	10	150	16	0	4.5	0	10	88	23		
2N3993A	TO-72	25	1	1.2*	15	10	10	10	10	150	12	-10	0	3	0	10	88	23	
2N3994	TO-72	25	1	1.2*	15	10	2	10	10	300	16	-10	0	4.5	0	10	88	23	
2N3994A	TO-72	25	1	1.2*	15	10	2	10	10	300	12	-10	0	3	0	10	88	23	
2N5018	TO-18	30	1	2	15	10	10	10	20	75	45	-15	0	10	0	12	88	11	
2N5019	TO-18	30	1	2	15	10	5	20	150	150	45	-15	0	10	0	7	90	125	
2N5114	TO-18	30	1	0.5	20	15	30	90	18	75	1	25	-15	0	7	0	12	16	21
2N5115	TO-18	30	1	0.5	20	15	16	60	15	100	1	25	-15	0	7	0	7	30	38
2N5116	TO-18	30	1	0.5	20	15	5	25	15	150	1	25	-15	0	7	0	5	42	60
J174	TO-92	30	1	1	20	10	20	100	15	85	1	11	0	10	5.5	0	10	2	5
J175	TO-92	30	1	1	20	10	7	60	15	125	5	11	0	10	5.5	0	10	5	10
J176	TO-92	30	1	1	20	10	2	25	15	250	25	11	0	10	5.5	0	10	15	15
J177	TO-92	30	1	1	20	10	1.5	20	15	300	1	11	0	10	5.5	0	10	20	20
P1086E	TO-92	30	1	2	20	10	10	10	15	75	1	45	-15	0	10	15	0	35	50
P1087E	TO-92	30	1	2	20	10	5	15	150	150	45	-15	0	10	15	0	40	75	88
U304	TO-18	30	1	0.5	20	10	30	90	15	85	27	-15	0	7	0	12	35	35	88
U305	TO-18	30	1	0.5	20	10	15	60	15	110	27	-15	0	7	0	7	50	45	88
U306	TO-18	30	1	0.5	20	10	5	25	15	175	27	-15	0	7	0	5	60	80	88

\* Note: JAN qualified per applicable MIL-S-19500 specification

## P-Channel FETs

### AMPLIFIERS

Transistor Type	Case Style	BV <sub>GSS</sub> BV <sub>GDO</sub> (V) @ I <sub>G</sub> Min	I <sub>GSS</sub> ID <sub>GDO</sub> (nA) @ V <sub>DG</sub> Max	V <sub>P</sub> (V) Min Max	I <sub>D</sub> (μA) Min Max	I <sub>DSS</sub> (mA) @ V <sub>DS</sub> Min Max	G <sub>fs</sub> (mmho) @ V <sub>DS</sub> Min Max	G <sub>oss</sub> (μmho) @ V <sub>DS</sub> Max	C <sub>iss</sub> (pF) @ V <sub>DS</sub> Max	V <sub>GS</sub> (V) Max	C <sub>rss</sub> @ V <sub>DS</sub> (V) Max	V <sub>GS</sub> (V) Max	C <sub>rss</sub> @ V <sub>DS</sub> (V) Max	V <sub>GS</sub> (V) Max	t <sub>on</sub> (ns) Max	t <sub>off</sub> (ns) Max	Process No.	Pkg. No.			
2N2608	TO-18	30	1	10	30	1	0.9	4.5	5	1	17	-5	1	125	1000	89	11				
2N2609	TO-18	30	1	30	30	1	2	10	5	2.5	30	-5	1	125	1000	88	11				
2N3329	TO-72	20	10	10	10	5	10	10	10	1	20	-10	1	125	1000	89	23				
2N3330	TO-72	20	10	10	10	6	10	2	6	1.5	3	10/2mA	40	10	20	10	1	125	1000	89	
2N3331	TO-72	20	10	10	10	8	10	5	15	10	2	4	10/5mA	100	10	20	10	1	155	1000	89
2N3332	TO-72	20	10	10	10	6	10	1	6	10	1	2.2	10/1mA	20	10	20	10	1	65	1000	89
2N4381	TO-18	25	1	1	15	1	3	12	15	2	6	15	75	15	20	10	1	20	1000	89	11

\* Note: JAN qualified per applicable MIL-S-19500 specification



# P-Channel FETS

## AMPLIFIERS (Continued)

Transistor Type	Case Style	BV <sub>GSD</sub> (V) @ I <sub>G</sub> (μA)		I <sub>GSS</sub> (nA) @ V <sub>DG</sub> (V)		V <sub>p</sub> @ V <sub>DS</sub> (V)		I <sub>DSS</sub> (mA) @ V <sub>DS</sub> (V)		G <sub>fs</sub> (mmho) @ V <sub>DS</sub> (V)		C <sub>oss</sub> (pF) @ V <sub>DS</sub> (V)		C <sub>iss</sub> (pF) @ V <sub>DS</sub> (V)		V <sub>GS</sub> (V)		C <sub>rss</sub> (pF) @ V <sub>DS</sub> (V)		V <sub>GS</sub> (V)		e <sub>n</sub> (NV/√Hz) @ Freq (Hz)		Process No.		Pkg. No.	
		Min	Max	Min	Max	Min	Max	Min	Max	Min	Max	Min	Max	Min	Max	Min	Max	Min	Max	Min	Max	Min	Max	Min	Max	Min	Max
2N5020	TO-18	25	1	15	0.3	1.5	-15	1	0.3	1.2	15	1	3.5	15	20	15	25	-15	0	7	-15	0	30	1000	89	11	
2N5021	TO-18	25	1	15	0.5	2.5	-15	1	1	3.5	15	1	3.5	15	20	15	25	-15	0	7	-15	0	30	1000	89	11	
2N5460	TO-92	40	10	5	0.75	6	-15	1	1	5	15	1	4	15	50	15	7	-15	0	2	-15	0	115	100	89	71	
2N5461	TO-92	40	10	5	20	1	7.5	-15	1	2	9	15	1.5	5	50	15	7	-15	0	2	-15	0	115	100	89	71	
2N5462	TO-92	40	10	5	20	1	1.8	-15	1	4	16	15	2	6	50	15	7	-15	0	2	-15	0	115	100	89	71	
J270	TO-92	30	1	0.2	0.5	2.0	15	.001	2	15	15	6.0	15.0	15	200	15	420	15	0	15	15	0	10	1k	88	74	
J271	TO-92	30	1	0.2	1.5	4.5	15	.001	5	50	15	8.0	18.0	15	500	15	120	15	0	15	15	0	110	1k	88	74	
PN4342	TO-92	25	10	10	15	15	5.5	-10	1	4	12	10	2	6	10	75	20	-10	0	5	-10	0	80	100	89	71	
PN4360	TO-92	20	10	10	15	15	0.7	10	-10	1	3	30	10	2	8	100	10	-10	0	5	-10	0	190	100	89	71	
PN5033	TO-92	20	10	10	15	15	0.3	2.5	-10	1	0.3	3.5	10	1	5	10	20	10	0	7	-10	0	100	1000	89	71	
U301	TO-18	40	1	0.1	20	2.5	60	-15	.001	15	60	7	11	15	20	-15	20	-15	7	7	7	7	40	1000	88	11	



# Pro-Electron FETS

## AMPLIFIERS

Type No.	Case Style	BV <sub>GSD</sub> (V) @ I <sub>G</sub> (μA)		I <sub>DGD</sub> (nA) @ V <sub>DG</sub> (V)		V <sub>p</sub> @ V <sub>DS</sub> (V)		I <sub>D</sub> @ V <sub>DS</sub> (μA)		V <sub>GS</sub> (V) @ V <sub>DS</sub> (V)		I <sub>DSS</sub> (mA) @ V <sub>DS</sub> (V)		R <sub>g</sub> (YFS) (mmho) @ f (MHz)		C <sub>iss</sub> (pF) @ V <sub>DS</sub> (V)		V <sub>GS</sub> (V)		C <sub>rss</sub> (pF) @ V <sub>DS</sub> (V)		V <sub>GS</sub> (V)		NF (dB) @ R <sub>G</sub> = 1k e <sub>n</sub> * (Hz) (MHz)		Process No.		Pkg. No.	
		Min	Max	Min	Max	Min	Max	Min	Max	Min	Max	Min	Max	Min	Max	Min	Max	Min	Max	Min	Max	Min	Max	Min	Max	Min	Max	Min	Max
BF244A	TO-92	30	1	5	20	5	8	15	10	4	2.2	15	200	2	6.5	15	3	6.5	.001	4	20	-1	1.1	20	-1	1.5	100	50	74
BF244B	TO-92	30	1	5	20	5	8	15	10	1.6	3.8	15	200	6	15	15	3	6.5	.001	4	20	-1	1.1	20	-1	1.5	100	50	74
BF244C	TO-92	30	1	5	20	5	8	15	10	3.2	7.5	15	200	12	25	15	3	6.5	.001	4	20	-1	1.1	20	-1	1.5	100	50	74
BF245A	TO-92	30	1	5	20	5	8	15	10	4	2.2	15	200	2	6.5	15	3	6.5	.001	4	20	-1	1.1	20	-1	1.5	100	50	77
BF245B	TO-92	30	1	5	20	5	8	15	10	1.6	3.8	15	200	6	15	15	3	6.5	.001	4	20	-1	1.1	20	-1	1.5	100	50	77
BF245C	TO-92	30	1	5	20	5	8	15	10	3.2	7.5	15	200	12	25	15	3	6.5	.001	4	20	-1	1.1	20	-1	1.5	100	50	77
BF246A	TO-92	25	1	5	15	6	14.5	15	10	1.5	4.0	15	200	30	80	15	8	.001	11	15	0	3.5	15	0	51	74			
BF246B	TO-92	25	1	5	15	6	14.5	15	10	3.0	7.0	15	200	60	140	15	8	.001	11	15	0	3.5	15	0	51	74			
BF246C	TO-92	25	1	5	15	6	14.5	15	10	5.5	12	15	200	110	250	15	8	.001	11	15	0	3.5	15	0	51	74			
BF247A	TO-92	25	1	5	15	6	14.5	15	10	1.5	4.0	15	200	30	80	15	8	.001	11	15	0	3.5	15	0	51	77			
BF247B	TO-92	25	1	5	15	6	14.5	15	10	3.0	7.0	15	200	60	140	15	8	.001	11	15	0	3.5	15	0	51	77			
BF247C	TO-92	25	1	5	15	6	14.5	15	10	5.5	12	15	200	110	250	15	8	.001	11	15	0	3.5	15	0	51	77			
BF256A	TO-92	30	1	5	20	5	8	15	10	5	7.5	15	200	3	7	15	4.5	.001	7	20	-1	.7	20	-1	7.5	800	50	77	
BF256B	TO-92	30	1	5	20	5	8	15	10	5	7.5	15	200	6	13	15	4.5	.001	7	20	-1	.7	20	-1	7.5	800	50	77	
BF256C	TO-92	30	1	5	20	5	8	15	10	5	7.5	15	200	11	18	15	4.5	.001	7	20	-1	.7	20	-1	7.5	800	50	77	
BC264A	TO-92	30	1	10	20	5	15	10	2	1.2	15	1000	2	4.5	15	2.5	.001	4.0	15	-1	1.2	15	-1	40*	10*	50	77		
BC264B	TO-92	30	1	10	20	5	15	10	4	1.4	15	1500	3.5	6.5	15	3.0	.001	4.0	15	-1	1.2	15	-1	40*	10*	50	77		
BC264C	TO-92	30	1	10	20	5	15	10	5	1.5	15	2500	5.0	8.0	15	3.5	.001	4.0	15	-1	1.2	15	-1	40*	10*	50	77		
BC264D	TO-92	30	1	10	20	5	15	10	6	1.6	15	3500	7.0	12.0	15	4.0	.001	4.0	15	-1	1.2	15	-1	40*	10*	50	77		



# JFET Selection Guide





Section 9  
Process  
Characteristics JFETs





# Process 50 N-Channel JFET

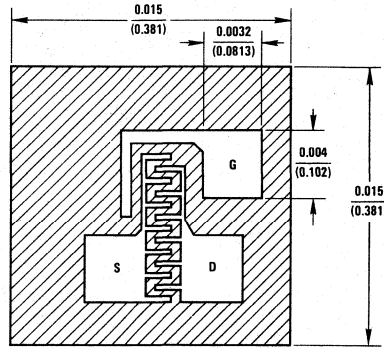

## DESCRIPTION

Process 50 is designed primarily for RF amplifier and mixer applications. It will operate up to 450 MHz with low noise figure and good power gain. These devices offer outstanding performance at VHF aircraft and communications frequencies. Their major advantage is low crossmodulation and intermodulation, low noise figure and good power gain. The device is also a good choice for analog switching where low capacitance is very important.

CHARACTERISTIC	PARAMETER	TEST CONDITIONS	MIN	TYP	MAX	UNITS
Gate-Source Breakdown Voltage	$BV_{GSS}$	$V_{DS} = 0V, I_G = -1 \mu A$	-25	-40		V
Zero Gate Voltage Drain Current	$I_{DSS}$	$V_{DS} = 15V, V_{GS} = 0V$	1.0	10	20	mA
Forward Transconductance	$g_{fs}$	$V_{DS} = 15V, V_{GS} = 0$	3.0	5.5	7.0	mmhos
Forward Transconductance	$g_{fs}$	$V_{DG} = 15V, I_D = 200 \mu A$		1.1		mmhos
Reverse Gate Leakage	$I_{GSS}$	$V_{GS} = -20V, V_{DS} = 0$		-5.0	-100	$\mu A$
"ON" Resistance	$r_{DS}$	$V_{DS} = 100 mV, V_{GS} = 0$	100	175	500	$\Omega$
Pinch Off Voltage	$V_{GS(OFF)}$	$V_{DS} = 15V, I_D = 1 nA$	-0.7	-3.5	-6.0	V
Output Conductance	$g_{os}$	$V_{DG} = 15V, I_D = 1 mA, f = 1 kHz$		10		$\mu mhos$
Feedback Capacitance	$C_{rss}$	$V_{DG} = 15V, V_{GS} = 0$		0.7	0.9	pF
Input Capacitance	$C_{iss}$	$V_{DS} = 15V, V_{GS} = 0$		3.5	4.0	pF
Noise Voltage	$e_n$	$V_{DG} = 15V, I_D = 1 mA, f = 100 Hz$		8.0		$nV/\sqrt{Hz}$
Noise Figure	NF	$V_{DG} = 15V, I_D = 5 mA, R_G = 1 k\Omega, f = 400 MHz$		2.2	4.0	dB
Power Gain	$G_{PS}$	$V_{DG} = 15V, I_D = 5 mA, f = 400 MHz$		12		dB

This process is available in the following device types. \*Denotes preferred parts.

### TO-72 (CASE 25)

- 2N3823
- 2N3966
- 2N4223
- 2N4224
- 2N4416
- \*2N4416A
- 2N5078
- 2N5103
- 2N5104
- 2N5105
- 2N5556
- 2N5557
- 2N5558

### TO-92 (CASE 72)

- \*2N5484
- \*2N5485

- \*2N5486
- 2N5555
- 2N5668
- 2N5669
- 2N5670
- \*J304
- \*J305
- PN4223
- PN4224
- \*PN4416
- PN5163
- MPF 102
- MPF 106
- MPF 107
- MPF 110
- MPF 111

### TO-92 (CASE 74)

- 2N3819
- 2N5248
- BF244A
- BF244B
- BF244C
- TIS58
- TIS59

### TO-92 (CASE 77)

- 2N5949
- 2N5950
- 2N5951
- 2N5952
- 2N5953
- BC264A
- BC264B

- BC264C
- BC264D
- BF245A
- BF245B
- BF245C
- BF256A
- BF256B
- BF256C

### QUALIFIED PER MIL-S-19500

- 2N3823JAN, JANTX, JANTXV
- 2N4416AJAN, JANTX, JANTXV

Transfer Characteristics

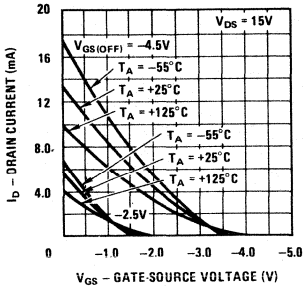

Channel Resistance vs Temperature

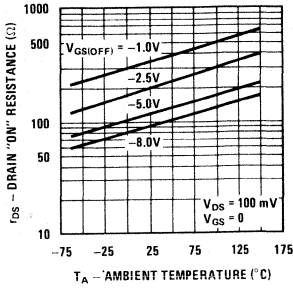

Leakage Current vs Voltage

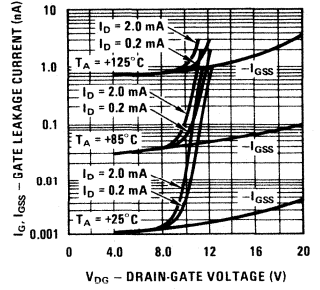

Transconductance Characteristics

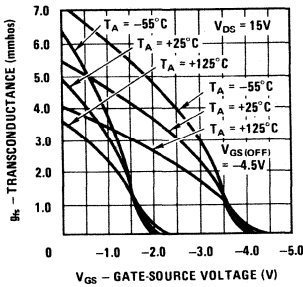

Common Drain-Source Characteristics

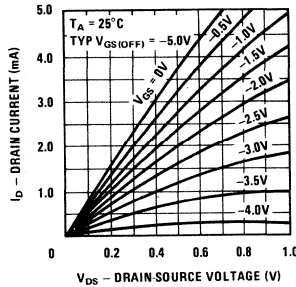

Output Conductance vs Drain Current

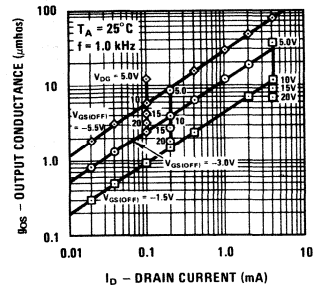

Parameter Interactions

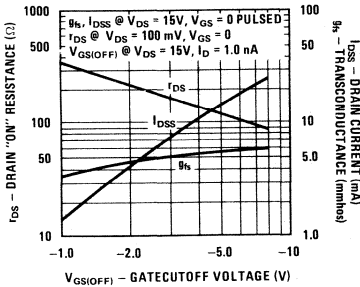

Transconductance vs Drain Current

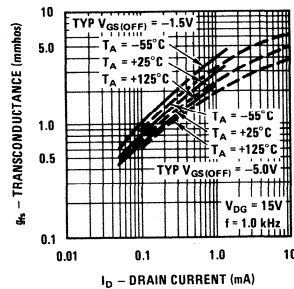

Noise Voltage vs Frequency

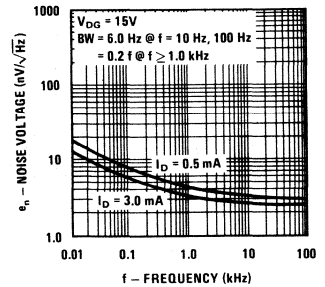

Capacitance vs Voltage

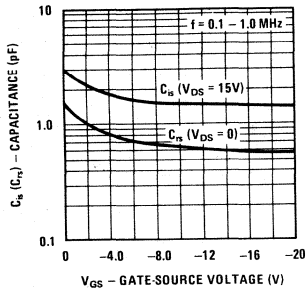

Noise Figure Frequency

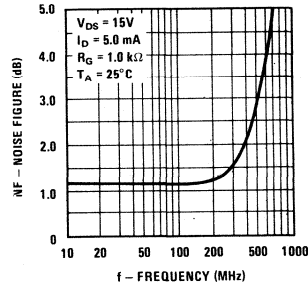

COMMON SOURCE

Input Admittance

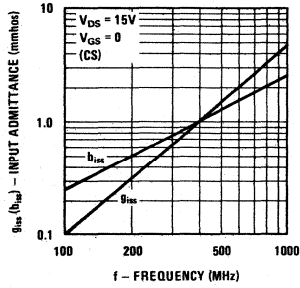

Forward Transmittance

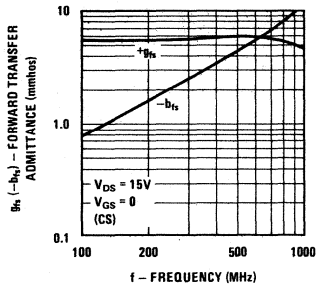

Output Admittance

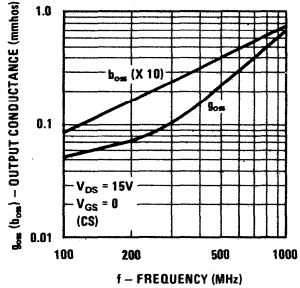

Reverse Transmittance

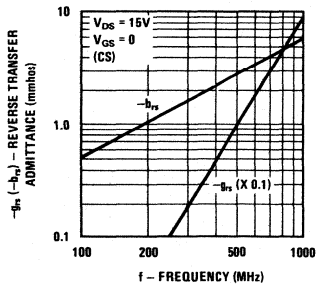

COMMON GATE

Input Admittance

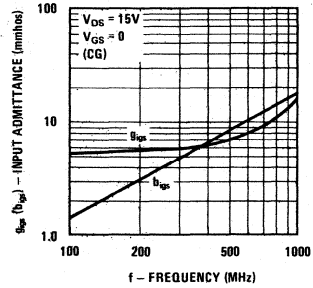

Forward Transmittance

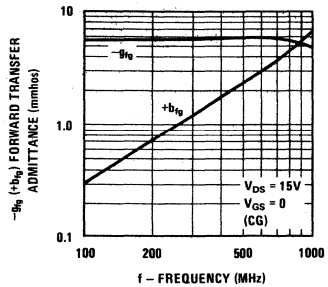

Output Admittance

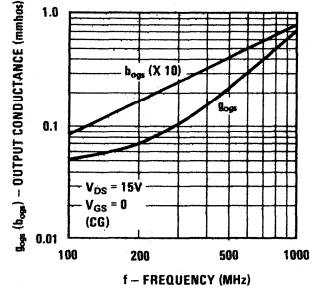

Reverse Transmittance

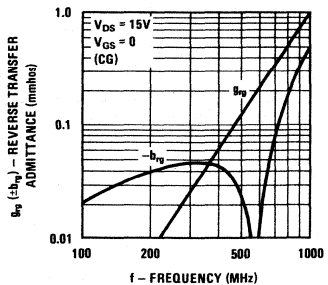





# Process 51 N-Channel JFET

Process 51

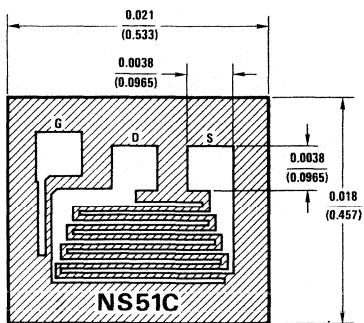

GATE IS ALSO BACKSIDE CONTACT

## DESCRIPTION

Process 51 is designed primarily for electronic switching applications such as low ON resistance analog switching. It features excellent  $C_{iss}$ ,  $R_{DS(ON)}$  time constant. The inherent zero offset voltage and low leakage current make these devices excellent for chopper stabilized amplifiers, sample and hold circuits, and reset switches. Low feed-through capacitance also allows them to handle video signals to 100 MHz.

CHARACTERISTIC	PARAMETER	TEST CONDITIONS	MIN	TYP	MAX	UNITS
Gate-Source Breakdown Voltage	$BV_{GSS}$	$V_{DS} = 0V, I_G = -1 \mu A$	-30	-50		V
Zero Gate Voltage Drain Current	$I_{DSS}$	$V_{DS} = 20V, V_{GS} = 0$ Pulse Test	5.0	65	170	mA
Reverse Gate Leakage	$I_{GSS}$	$V_{GS} = -20V, V_{DS} = 0$		-15	-200	pA
"ON" Resistance	$r_{DS}$	$V_{DS} = 100 mV, V_{GS} = 0$	20	35	100	$\Omega$
Forward Trans-conductance	$g_{fs}$	$V_{DG} = 15V, I_D = 2 mA$		8.5		mmhos
Pinch Off Voltage	$V_{GS(OFF)}$	$V_{DS} = 20V, I_D = 1 nA$	-0.5	-4.5	-9.0	V
Drain "OFF" Current	$I_{D(OFF)}$	$V_{DS} = 20V, V_{GS} = -10V$		15	200	pA
Feedback Capacitance	$C_{rss}$	$V_{DG} = 15V, I_D = 5 mA, f = 1 MHz$		3.5	4.0	pF
Input Capacitance	$C_{iss}$	$V_{DS} = 15V, I_D = 5 mA, f = 1 MHz$		12	16	pF
Noise Voltage	$e_n$	$V_{DG} = 15V, I_D = 1 mA, f = 100 Hz$		6.0		$nV/\sqrt{Hz}$
Turn-On Time	$t_{on}$	$V_{DD} = 10V, I_D = 6.6 mA$		12	20	ns
Turn-Off Time	$t_{off}$	$V_{DD} = 10V, I_D = 6.6 mA$		40	80	ns

This process is available in the following device types. \*Denotes preferred parts.

### TO-18 (CASE 02)

2N3970  
2N3971  
2N3972  
\*2N4091  
\*2N4092  
\*2N4093  
\*2N4391  
\*2N4392  
\*2N4393  
\*2N4856  
2N4856A  
\*2N4857  
2N4857A  
\*2N4858  
2N4858A  
2N4859  
2N4859A  
2N4860  
2N4860A

2N4861  
2N4861A  
**TO-72 (CASE 25)**  
\*NF5101  
\*NF5102  
\*NF5103  
**TO-92 (CASE 72)**  
\*2N5638  
\*2N5639  
\*2N5640  
2N5653  
2N5654  
\*J111  
\*J112  
\*J113  
\*PF5101  
\*PF5102  
\*PF5103  
\*PN4091

\*PN4092  
\*PN4093  
\*PN4391  
\*PN4392  
\*PN4393  
\*PN4856  
\*PN4857  
\*PN4858  
\*PN4859  
\*PN4860  
\*PN4861  
U1897E  
U1898E  
U1899E  
**TO-92 (CASE 74)**  
BF246A  
BF246B  
BF246C

### TO-92 (CASE 77)

BF247A  
BF247B  
BF247C  
T1S73  
T1S74  
T1S75

### QUALIFIED PER MIL-S-19500

2N4091 JAN, JANTX  
2N4092 JAN, JANTX  
2N4093 JAN, JANTX, JANTXV  
2N4856 JAN, JANTX, JANTXV  
2N4857 JAN, JANTX, JANTXV  
2N4858 JAN, JANTX, JANTXV  
2N4859 JAN, JANTX, JANTXV  
2N4860 JAN, JANTX, JANTXV  
2N4861 JAN, JANTX, JANTXV







# Process 52 N-Channel JFET

Process 52

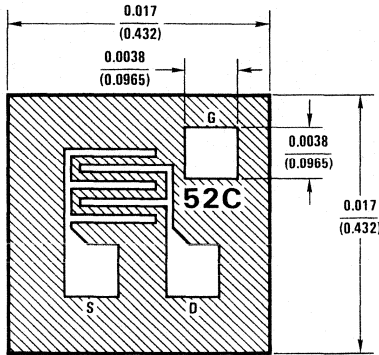

GATE IS ALSO BACKSIDE CONTACT

## DESCRIPTION

Process 52 is designed primarily for low level audio and general purpose applications. These devices provide excellent performance as input stages for piezo electric transducers or other high impedance signal sources. Their high output impedance and high voltage breakdown lend them to high gain audio and video amplifier applications. Source and drain are interchangeable.

CHARACTERISTIC	PARAMETER	CONDITIONS	MIN	TYP	MAX	UNITS
Gate-Source Breakdown Voltage	$BV_{GSS}$	$V_{DS} = 0V, I_G = -1 \mu A$	-40	-70		V
Drain Saturation Current	$I_{DSS}$	$V_{DS} = 20V, V_{GS} = 0V$	0.2	1.5	12	mA
Forward Transconductance	$g_{fs}$	$V_{DS} = 20V, V_{GS} = 0V$	1.0	2.5	5.0	mmho
Forward Transconductance	$g_{fs}$	$V_{DS} = 20V, I_D = 200 \mu A$		700		$\mu mho$
Reverse Gate Leakage Current	$I_{GSS}$	$V_{GS} = -30V, V_{DS} = 0V$		-10		pA
Drain ON Resistance	$r_{DS}$	$V_{DS} = 100 mV, V_{GS} = 0V$	250	400	2000	$\Omega$
Gate Cutoff Voltage	$V_{GS(OFF), VP}$	$V_{DS} = 15V, I_D = 1 nA$	-0.3	1.0	-8.0	V
Output Conductance	$g_{os}$	$V_{DG} = 15V, I_D = 200 \mu A$		2.0		$\mu mho$
Feedback Capacitance	$C_{rss}$	$V_{DG} = 15V, V_{GS} = 0V, f = 1 MHz$		1.3	1.8	pF
Input Capacitance	$C_{iss}$	$V_{DG} = 15V, V_{GS} = 0V, f = 1 MHz$		5	6	pF
Noise Voltage	$e_n$	$V_{DG} = 15V, I_D = 200 \mu A, f = 100 Hz$		10		$nV/\sqrt{Hz}$

This process is available in the following device types.  
 \* Denotes preferred parts.

TO-18 (CASE 02)	TO-72 (CASE 25)	TO-92 (CASE 72)
2N3069	*2N3684	*J201
2N3070	*2N3685	*J202
2N3071	*2N3686	*J203
2N3368	*2N3687	*PN3684
2N3369	2N3967	*PN3685
2N3370	2N3967A	*PN3686
2N3458	2N3968	*PN3687
2N3459	2N3968A	*PN4302
2N3460	2N3969	*PN4303
*2N4338	2N3969A	*PN4304
*2N4339		
*2N4340		
*2N4341		



Transfer Characteristics

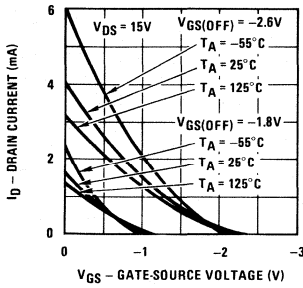

Transfer Characteristics

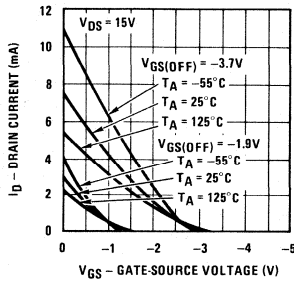

Common Drain-Source Characteristics

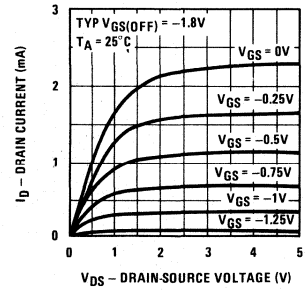

Transfer Characteristics

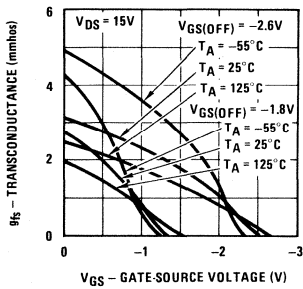

Transfer Characteristics

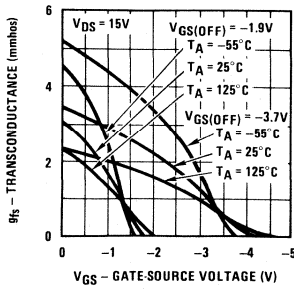

Parameter Interactions

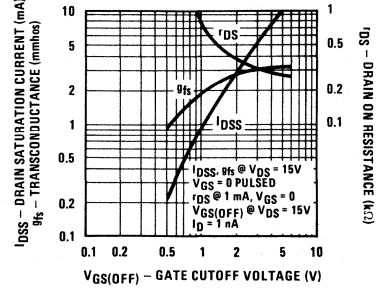

Output Conductance vs Drain Current

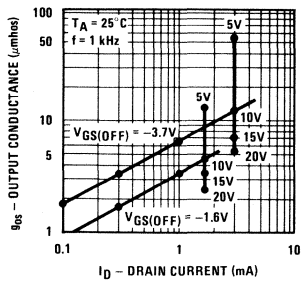

Transconductance vs Drain Current

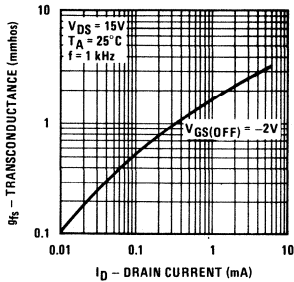

Channel Resistance vs Temperature

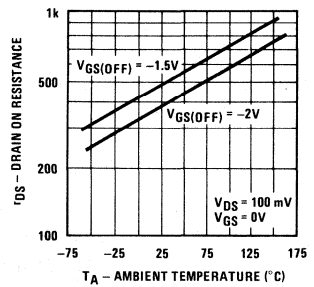

Noise Voltage vs Frequency

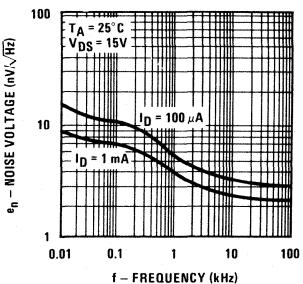

Leakage Current vs Voltage

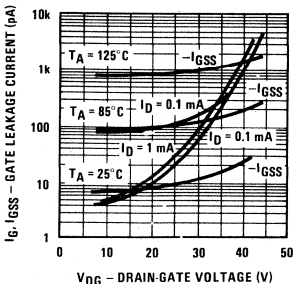

Capacitance vs Voltage

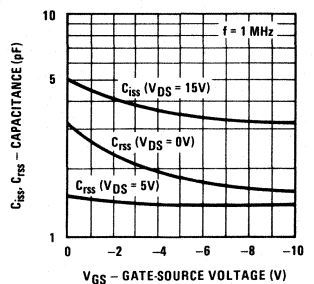



# Process 53 N-Channel JFET

Process 53

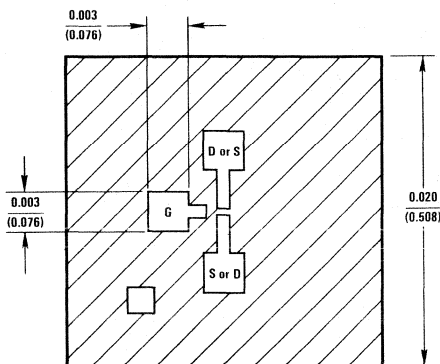

## DESCRIPTION

Process 53 is designed primarily for low current DC and audio applications. These devices provide excellent performance as input stages for sub pico-amp instrumentation or any high impedance signal sources.

CHARACTERISTIC	PARAMETER	TEST CONDITIONS	MIN	TYP	MAX	UNITS
Gate-Source Breakdown Voltage	$BV_{GSS}$	$V_{DS} = 0V, I_G = -1 \mu A$	-40	-60		V
Zero Gate Voltage Drain Current	$I_{DSS}$	$V_{DS} = 10V, V_{GS} = 0$	0.02	0.25	1.0	mA
Forward Transconductance	$g_{fs}$	$V_{DS} = 10V, V_{GS} = 0$	80	250	350	$\mu mho$
Forward Transconductance	$g_{fs}$	$V_{DG} = 15V, I_D = 50 \mu A$		120		$\mu mho$
Reverse Gate Leakage	$I_{GSS}$	$V_{GS} = -20V, V_{DS} = 0$		-0.3	-10	$\mu A$
Pinch Off Voltage	$V_{GS(OFF)}$	$V_{DS} = 10V, I_D = 1 nA$	-0.5	-2.2	-6.0	V
Feedback Capacitance	$C_{rss}$	$V_{DG} = 15V, V_{GS} = 0, f = 1 MHz$		0.85	1.0	pF
Input Capacitance	$C_{iss}$	$V_{DS} = 15V, V_{GS} = 0, f = 1 MHz$		2.0	2.5	pF
Output Conductance	$g_{os}$	$V_{DG} = 10V, I_D = 50 \mu A$		0.9	5.0	$\mu mhos$
Noise Voltage	$e_n$	$V_{DG} = 10V, I_D = 50 \mu A, f = 100 Hz$		45	150	$nV/\sqrt{Hz}$

This process is available in the following device types.

\* Denotes preferred parts.

### TO-72 (CASE 25)

- 2N4117
- \*2N4117A
- 2N4118
- \*2N4118A
- 2N4119
- \*2N4119A
- \*NF5301

Parameter Interactions

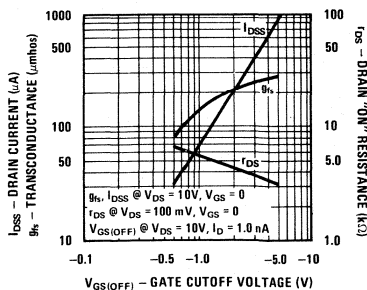

Leakage Current vs Voltage

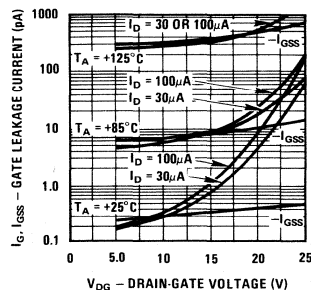

Transfer Characteristics

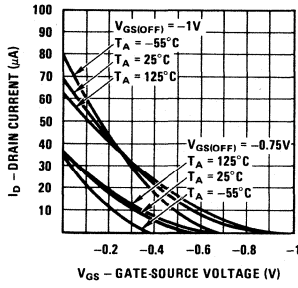

Transfer Characteristics

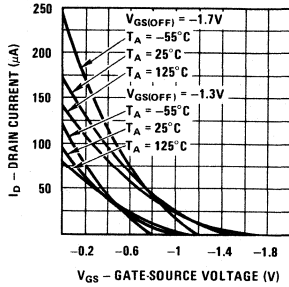

Transfer Characteristics

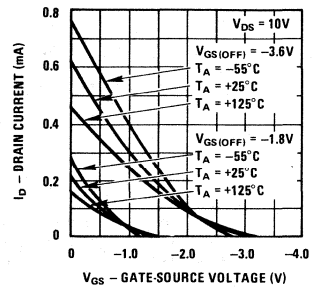

Transfer Characteristics

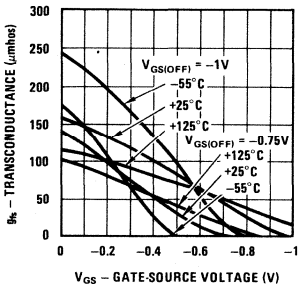

Transfer Characteristics

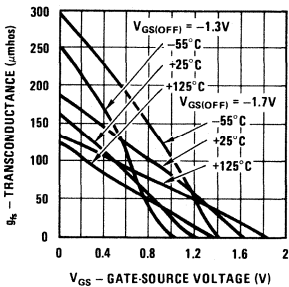

Transfer Characteristics

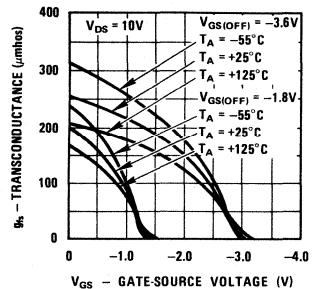

Common Drain-Source Characteristics

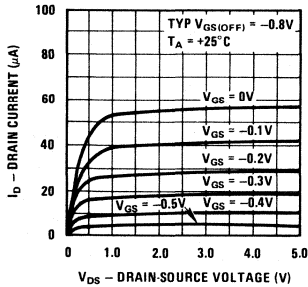

Output Conductance vs Drain Current

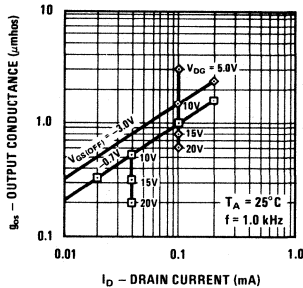

Capacitance vs Voltage

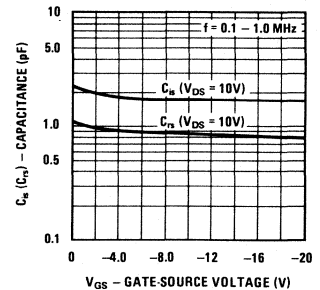

Transconductance vs Drain Current

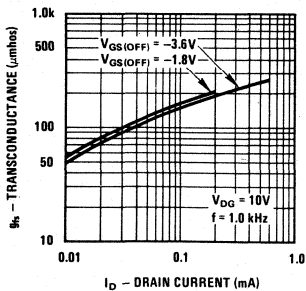

Noise Voltage vs Frequency

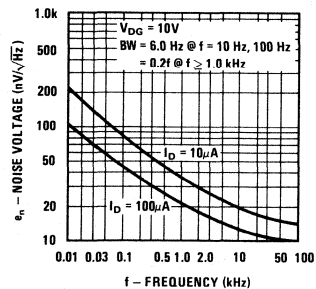



# Process 55 N-Channel JFET

Process 55

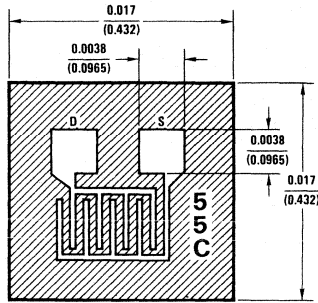

GATE IS BACKSIDE CONTACT

## DESCRIPTION

Process 55 is a general purpose low level audio amplifier and switching transistor. Wafer processing is similar to process 52 but process 55 uses a larger geometry. This results in higher  $Y_{fs}$ ,  $I_{DSS}$ , and capacitance and lower  $R_{DS(ON)}$ . It is useful for audio and video frequency amplifiers and RF amplifiers under 50 MHz. It may also be used for analog switching applications.

CHARACTERISTIC	PARAMETER	TEST CONDITIONS	MIN	TYP	MAX	UNITS
Gate-Source Breakdown Voltage	$BV_{GSS}$	$V_{DS} = 0V, I_G = -1 \mu A$	-40	-70		V
Zero Gate Voltage Drain Current	$I_{DSS}$	$V_{DS} = 20V, V_{GS} = 0$	0.5	5.0	20	mA
Forward Transconductance	$g_{fs}$	$V_{DS} = 20V, V_{GS} = 0$	2.0	4.5	7.0	mmho
Forward Transconductance	$g_{fs}$	$V_{DG} = 15V, I_D = 200 \mu A$		1200		$\mu mhos$
Reverse Gate Leakage	$I_{GSS}$	$V_{GS} = -30V, V_{DS} = 0$		-10	-100	$\mu A$
"ON" Resistance	$r_{DS}$	$V_{DS} = 100 mV, V_{GS} = 0$	140	250	600	$\Omega$
Pinch Off Voltage	$V_{GS(OFF)}$	$V_{DS} = 20V, I_D = 1 nA$	-0.5	-2.0	-8.0	V
Feedback Capacitance	$C_{rss}$	$V_{DG} = 15V, V_{GS} = 0, f = 1 MHz$		1.5	2.0	pF
Input Capacitance	$C_{iss}$	$V_{DS} = 15V, V_{GS} = 0, f = 1 MHz$		6.0	7.0	pF
Output Conductance	$g_{os}$	$V_{DG} = 15V, I_D = 200 \mu A$		2		$\mu mhos$
Noise Voltage	$e_n$	$V_{DG} = 15V, I_D = 200 \mu A, f = 100 Hz$		10		$nV/\sqrt{Hz}$

This process is available in the following device types. \*Denotes preferred parts.

### TO-18 (CASE 02)

	*2N5361
2N3436	*2N5362
2N3437	*2N5363
2N3438	*2N5364

### TO-72 (CASE 25)

2N3821	*2N5457
2N3822	*2N5458
2N3824	*2N5459
2N4220	MPF 103
2N4220A	MPF 104
2N4221	MPF 105
2N4221A	MPF 108
2N4222	MPF 109
2N4222A	MPF 112
*2N5358	PN4220
*2N5359	PN4221
*2N5360	PN4222

### TO-92 (CASE 72)

	*2N5457
	*2N5458
	*2N5459
	MPF 103
	MPF 104
	MPF 105
	MPF 108
	MPF 109
	MPF 112
	PN4220
	PN4221
	PN4222



Transfer Characteristics

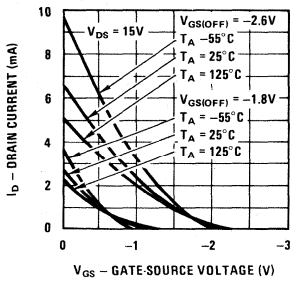

Transfer Characteristics

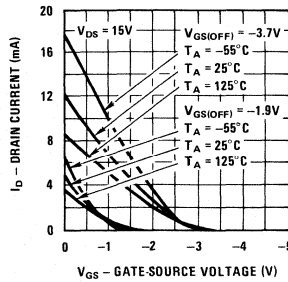

Common Drain-Source Characteristics

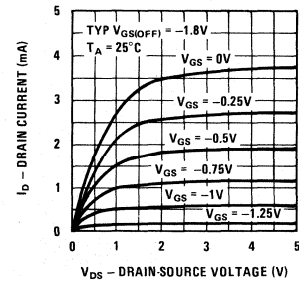

Transfer Characteristics

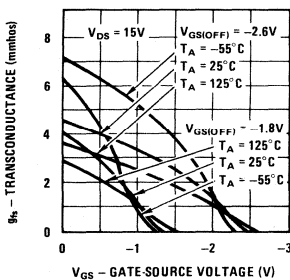

Transfer Characteristics

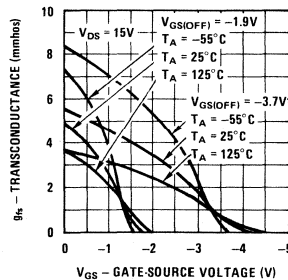

Parameter Interaction

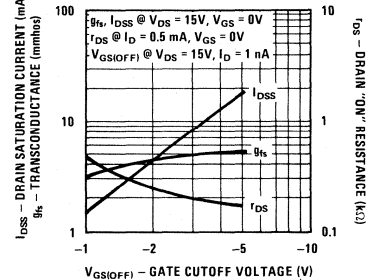

Output Conductance vs Drain Current

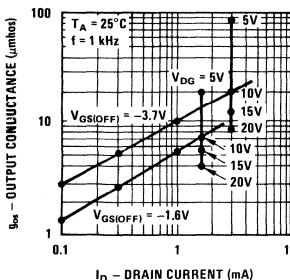

Transconductance vs Drain Current

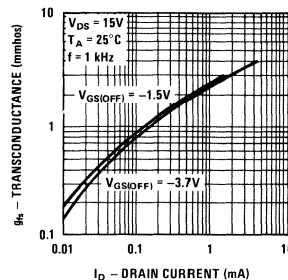

Channel Resistance vs Temperature

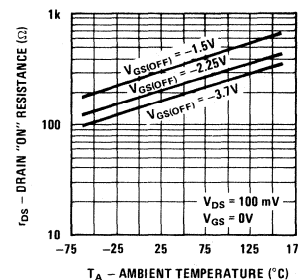

Noise Voltage vs Frequency

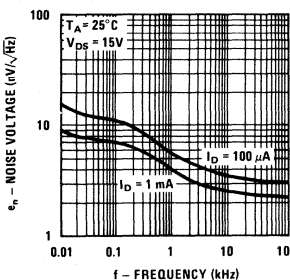

Leakage Current vs Voltage

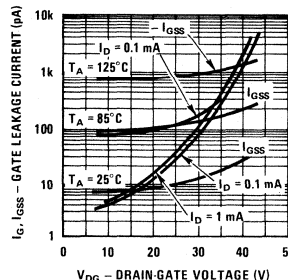

Capacitance vs Voltage

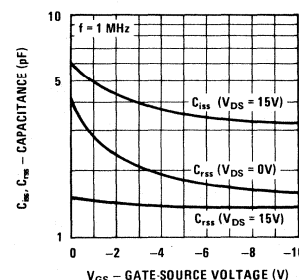





# Process 58 N-Channel JFET

## DESCRIPTION

Process 58 was developed for analog or digital switching applications where very low  $r_{DS(ON)}$  is mandatory. Switching times are very fast and  $R_{DS(ON)} C_{iss}$  time constant is low. The  $6\Omega$  typical on resistance is very useful in precision multiplex systems where switch resistance must be held to an absolute minimum. With  $r_{DS}$  increasing only 0.7%/°C, accuracy is retained over a wide temperature excursion.

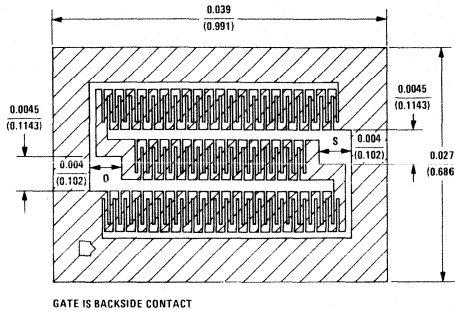

CHARACTERISTIC	PARAMETER	TEST CONDITIONS	MIN	TYP	MAX	UNITS
Gate-Source Breakdown Voltage	$BV_{GSS}$	$V_{DS} = 0V, I_G = -1 \mu A$	-25	-30		V
Zero Gate Voltage Drain Current	$I_{DSS}$	$V_{DS} = 5V, V_{GS} = 0$ Pulse Test	100	400	1000	mA
Reverse Gate Leakage	$I_{GSS}$	$V_{GS} = -15V, V_{DS} = 0$		-50	-500	$\mu A$
"ON" Resistance	$r_{DS}$	$V_{DS} = 100 mV, V_{GS} = 0$	3.0	6.0	20	$\Omega$
Pinch Off Voltage	$V_{GS(OFF)}$	$V_{DS} = 5V, I_D = 3 nA$	-0.5	-5.0	-12	V
Drain "OFF" Current	$I_{D(OFF)}$	$V_{DS} = 5V, V_{GS} = -10V$		0.05	20	nA
Feedback Capacitance	$C_{rss}$	$V_{DG} = 15V, I_D = 2 mA, f = 1 MHz$		12	25	pF
Input Capacitance	$C_{iss}$	$V_{DG} = 15V, I_D = 2 mA, f = 1 MHz$		25	50	pF
Forward Transconductance	$g_{fs}$	$V_{DG} = 10V, I_D = 2 mA$		10		mmhos
Output Conductance	$g_{os}$	$V_{DG} = 10V, I_D = 2 mA$		100		$\mu mhos$
Noise Voltage	$e_n$	$V_{DG} = 15V, I_D = 2 mA, f = 100 Hz$		6.0		$nV/\sqrt{Hz}$

This process is available in the following device types. \*Denotes preferred parts.

### TO-39 (CASE 09)

U320  
U321  
U322

### TO-52 (CASE 07)

\*2N5432  
\*2N5433  
\*2N5434

### TO-92 (CASE 72)

\*J108  
\*J109  
\*J110



Common Drain-Source Characteristics

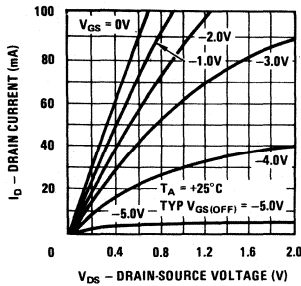

Parameter Interactions

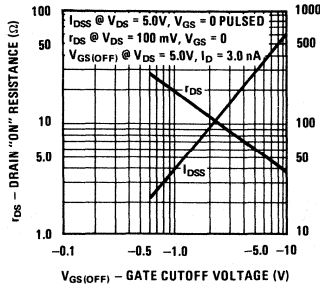

"ON" Resistance vs Drain Current

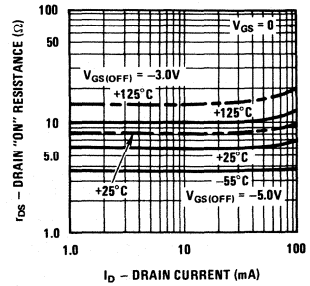

Common Drain-Source Characteristics

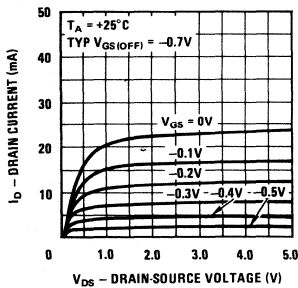

Normalized Drain Resistance vs Bias Voltage

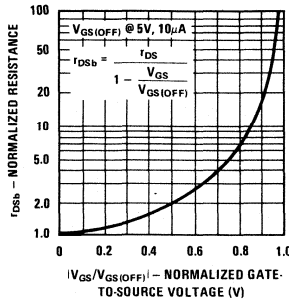

Leakage Current vs Voltage

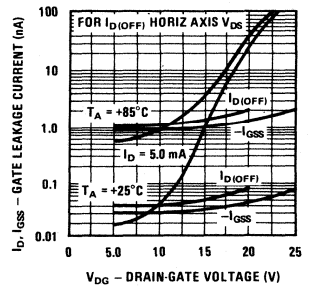

Output Conductance vs Drain Current

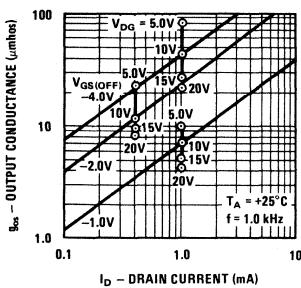

Transconductance vs Drain Current

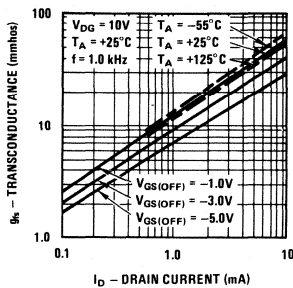

Noise Voltage vs Frequency

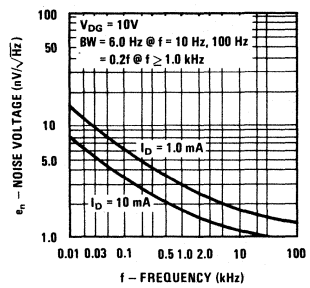

Capacitance vs Voltage

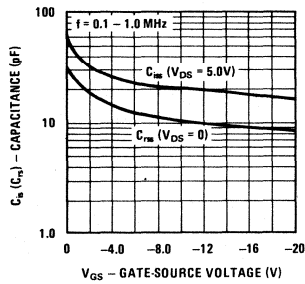

Switching Turn-On vs Gate-Source Voltage

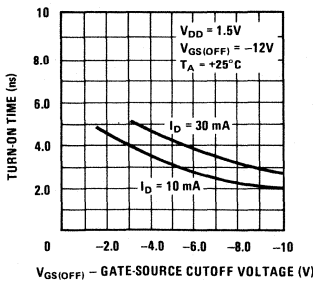

Switching Turn-On Time vs Drain Current

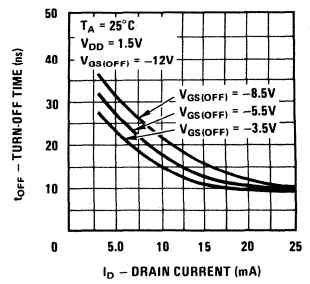



# Process 83 N-Channel Monolithic Dual JFET

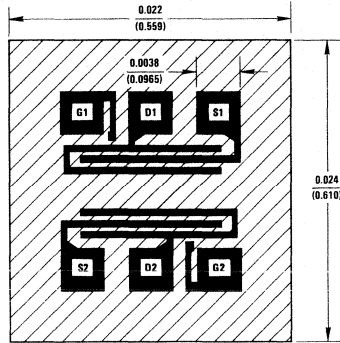

## DESCRIPTION

Process 83 is a monolithic dual JFET with a diode isolated substrate. It is intended for operational amplifier input buffer applications. Processing results in low input bias current and virtually unmeasurable offset current. Likewise matching characteristics are virtually independent of operating current and voltage, providing design flexibility. Most GP 2N types are sorted from this family.

CHARACTERISTIC	PARAMETER	TEST CONDITIONS	MIN	TYP	MAX	UNITS
Gate-Source Breakdown Voltage	$BV_{GSS}$	$V_{DS} = 0V, I_G = -1 \mu A$	-50	-70		V
Zero Gate Voltage Drain Current	$I_{DSS}$	$V_{DS} = 15V, V_{GS} = 0$	0.5	2.5	8.0	mA
Forward Transconductance	$g_{fs}$	$V_{DS} = 15V, V_{GS} = 0$	1.0	2.5	5.0	mmho
Pinch Off Voltage	$V_{GS(OFF)}$	$V_{DS} = 15V, I_D = 1 nA$	-0.5	-2.0	-4.5	V
Gate Current	$I_G$	$V_{DG} = 20V, I_D = 0.2 mA$		3.0	50	pA
Forward Transconductance	$g_{fs}$	$V_{DG} = 15V, I_D = 0.2 mA$	600	850		$\mu mhos$
Output Conductance	$g_{os}$	$V_{DG} = 15V, I_D = 0.2 mA$		1.0	5.0	$\mu mhos$
"ON" Resistance	$r_{DS}$	$V_{DS} = 100 mV, V_{GS} = 0$		450		$\Omega$
Noise Voltage	$e_n$	$V_{DG} = 15V, I_D = 0.2 mA$ $f = 100 Hz$		10	50	$nV/\sqrt{Hz}$
Differential Match	$ V_{GS1} - V_{GS2} $	$V_{DG} = 15V, I_D = 0.2 mA$		7.0	25	mV
Differential Match	$\Delta V_{GS1-2}$	$V_{DG} = 15V, I_D = 0.2 mA$		10	50	$\mu V/^\circ C$
Common Mode Rejection	CMRR	$V_{DG} = 15V, I_D = 0.2 mA$	80	95		dB
Feedback Capacitance	$C_{fs}$	$V_{DG} = 15V, I_D = 0.2 mA,$ $f = 1 MHz$		1.0	1.2	pF
Input Capacitance	$C_{is}$	$V_{DG} = 15V, I_D = 0.2 mA,$ $f = 1 MHz$		3.4	4.0	pF

This process is available in the following device types. \* Denotes preferred parts.

### TO-71 (CASE 12)

2N3921      2N5047      U233  
 2N3922      \*2N5196      U234  
 \*2N3954      \*2N5197      U235  
 \*2N3954A      \*2N5198  
 \*2N3955      \*2N5199  
 \*2N3955A      2N5452  
 \*2N3956      2N5453  
 \*2N3957      2N5454  
 \*2N3958      \*2N5545  
 2N4084      \*2N5546  
 2N4085      \*2N5547  
 2N5045      U231  
 2N5046      U232

### 8-Pin MiniDIP (CASE 60)

J410  
 J411  
 J412

### 8-Pin MiniDIP (CASE 67)

\*NPD8301  
 \*NPD8302  
 \*NPD8303

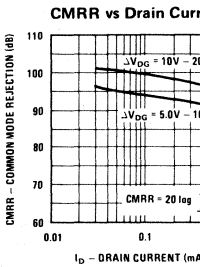
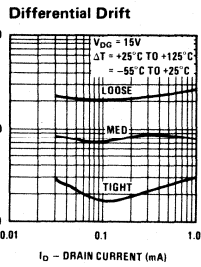
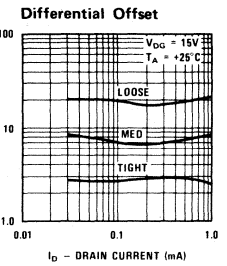
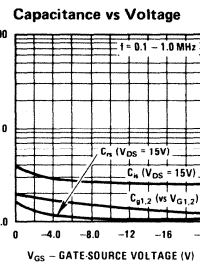
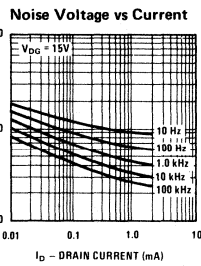
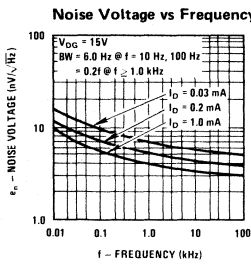
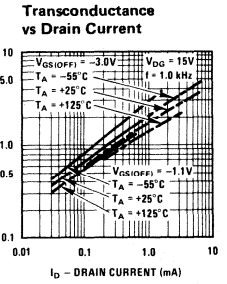
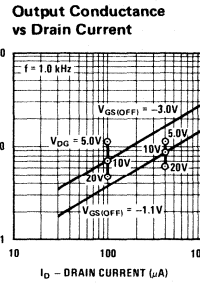
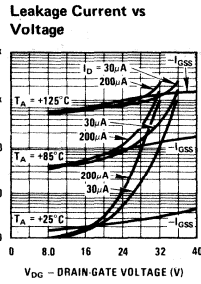
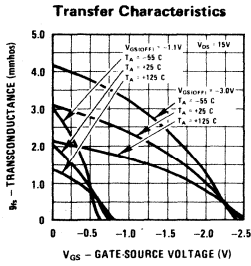
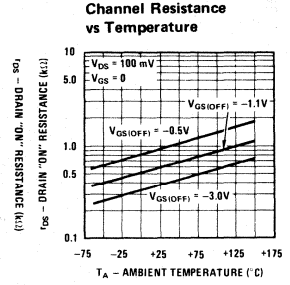
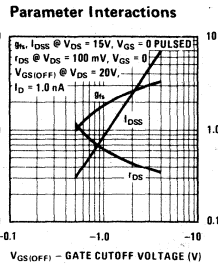
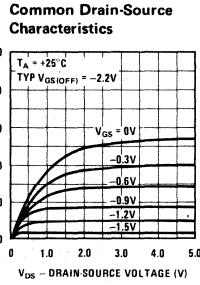
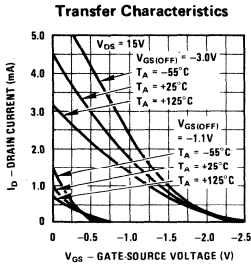



# Process 84 N-Channel Monolithic Dual JFET

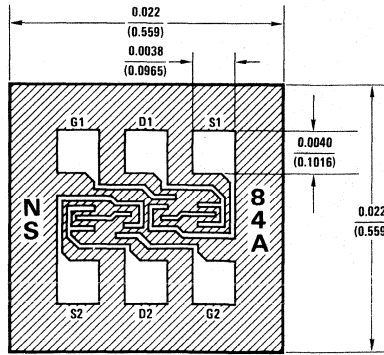

## DESCRIPTION

Process 84 is a monolithic dual JFET with a diode isolated substrate. It is designed for the most critical operational amplifier input stages or electrometer single ended preamp. Ideal for medical applications and instrumentation inputs where subpicoamp inputs are important. Device design considered high CMRR, subpicoamp leakage over wide input swings, low capacitance, and tight match over wide current range.

CHARACTERISTIC	PARAMETER	CONDITIONS	MIN	TYP	MAX	UNITS
Gate-Source Breakdown Voltage	$BV_{GSS}$	$V_{DS} = 0V, I_G = -1 \mu A$	-40	-60		V
Drain Saturation Current	$I_{DSS}$	$V_{DS} = 15V, V_{GS} = 0V$	20	300	1000	$\mu A$
Forward Transconductance	$g_{fs}$	$V_{DS} = 15V, V_{GS} = 0V$	90	180	300	$\mu mhos$
Forward Transconductance	$g_{fs}$	$V_{DS} = 15V, I_D = 30 \mu A$	50	120	150	$\mu mhos$
Gate Cutoff Voltage	$V_{GS(OFF)}$	$V_{DS} = 15V, I_D = 1 nA$	0.5	2	4.5	V
Reverse Gate Leakage Current	$I_{GSS}$	$V_{DS} = 0V, V_{GS} = -20V$		1	5	$\mu A$
Gate Leakage Current	$I_G$	$V_{DG} = 10V, I_D = 30 \mu A$		0.5	3	$\mu A$
Feedback Capacitance	$C_{rss}$	$V_{DS} = 15V, V_{GS} = 0, f = 1 MHz$		0.3	0.4	pF
Input Capacitance	$C_{iss}$	$V_{DS} = 15V, V_{GS} = 0, f = 1 MHz$		2	3	pF
Noise Voltage	$e_n$	$V_{DS} = 15V, I_D = 30 \mu A, f = 1 kHz$		30	50	$nV/\sqrt{Hz}$
Noise Voltage	$e_n$	$V_{DS} = 15V, I_D = 30 \mu A, f = 10 Hz$		180		$nV/\sqrt{Hz}$
Output Conductance	$g_{os}$	$V_{DS} = 10V, I_D = 30 \mu A$		0.01	0.02	$\mu mhos$
Differential Gate-Source Voltage	$ V_{GS1} - V_{GS2} $	$V_{DS} = 10V, I_D = 30 \mu A$		12	25	mV
Differential Gate-Source Voltage Drift	$\Delta V_{GS1-2}$	$V_{DS} = 10V, I_D = 30 \mu A$		10	50	$\mu V/^\circ C$
Common-Mode Rejection Ratio	CMRR	$V_{DS} = 10V, I_D = 30 \mu A$		112		dB

This process is available in the following device types. \*Denotes preferred parts.

### TO-78 (CASE 24)

- 2N5902 \*2N5906
- 2N5903 \*2N5907
- 2N5904 \*2N5908
- 2N5905 \*2N5909

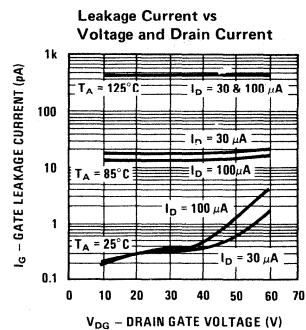
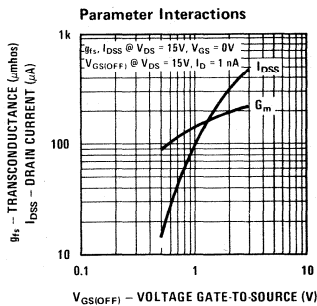

Transfer Characteristics

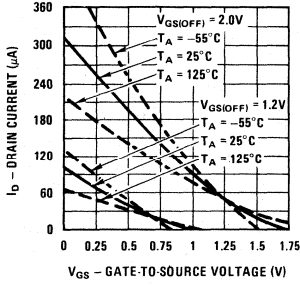

Common Drain-Source Characteristics

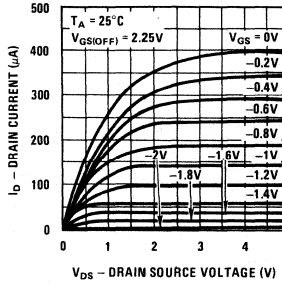

Leakage Current vs Voltage

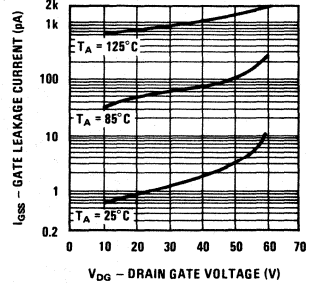

Transfer Characteristics

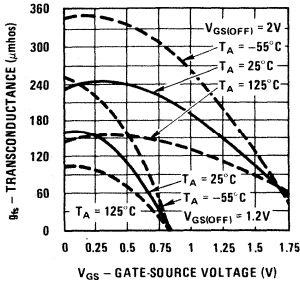

Transconductance vs Drain Current

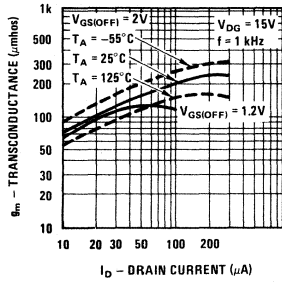

Output Conductance vs Drain Current

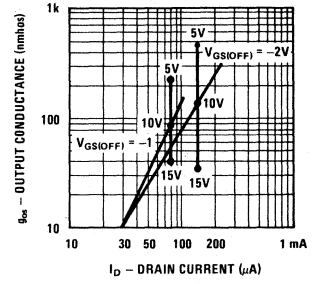

Noise Voltage vs Frequency

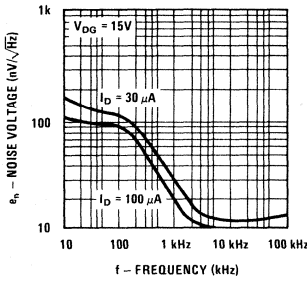

Noise Voltage vs Current

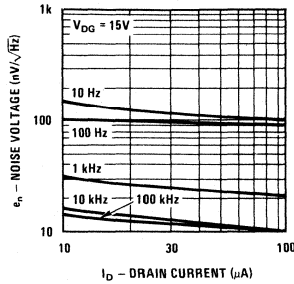

Capacitance vs Voltage

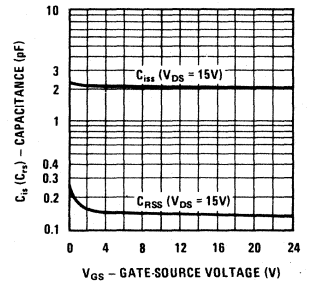

Differential Offset

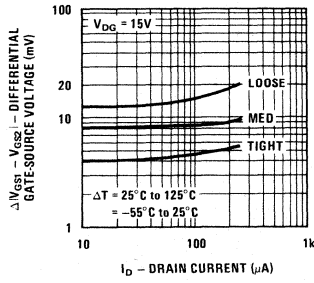

Differential Drift

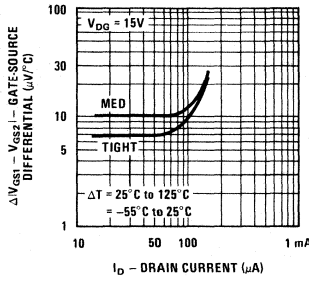

CMRR vs Drain Current

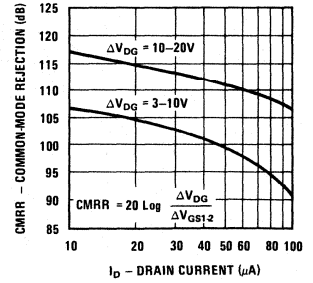



# Process 86 N-Channel Monolithic Dual JFET

Process 86

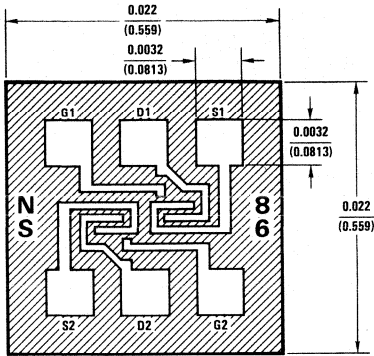

## DESCRIPTION

Process 86 is a monolithic dual JFET with a diode isolated substrate. It is intended for critical amplifier input stages requiring low noise, sub picoamp bias currents and high gain. Exacting process control results in consistent parameter distribution with tight match and low drift.

This process is available in the following device types.  
\*Denotes preferred parts.

## TO-78 (CASE 24)

U421  
U422  
U423  
U424  
U425  
U426

**PROCESS IN DEVELOPMENT**

9



# Process 88 P-Channel JFET

## DESCRIPTION

Process 88 is designed primarily for electronic switching applications where a P channel device is desirable. Inherent zero offset voltage, low leakage and low  $R_{DS(ON)}$   $C_{iss}$  time constant make this device excellent for low level analog switching, sample and hold circuits and chopper stabilized amplifiers. This device is the complement to Process 51.

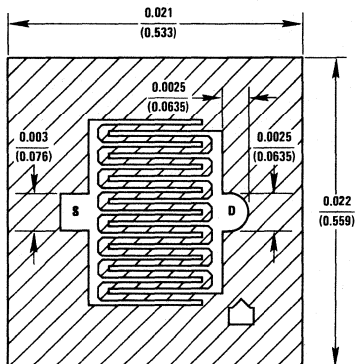

GATE IS BACKSIDE CONTACT

CHARACTERISTIC	PARAMETER	TEST CONDITIONS	MIN	TYP	MAX	UNITS
Gate-Source Breakdown Voltage	$BV_{GSS}$	$V_{DS} = 0V, I_G = 1 \mu A$	30	40		V
Zero Gate Voltage Drain Current	$I_{DSS}$	$V_{DS} = -15V, V_{GS} = 0$	-5.0	-30	-90	mA
Forward Transconductance	$g_{fs}$	$V_{DS} = -15V, V_{GS} = 0$	4.0	13	17	mmhos
Forward Transconductance	$g_{fs}$	$V_{DG} = -15V, I_D = -2 mA$		3.5		mmhos
Gate Leakage	$I_{GSS}$	$V_{GS} = 20V, V_{DS} = 0$		0.05	1.0	nA
"ON" Resistance	$r_{DS}$	$V_{DS} = -100 mV, V_{GS} = 0$	50	80	200	$\Omega$
Pinch Off Voltage	$V_{GS(OFF)}$	$V_{DS} = -15V, I_D = -1 nA$	0.5	5.0	10	V
Drain "OFF" Current	$I_{D(OFF)}$	$V_{DS} = -15V, V_{GS} = 10V$		-0.05	-10	nA
Feedback Capacitance	$C_{rss}$	$V_{DG} = -15V, I_D = -2 mA, f = 1 MHz$		4.0	5.0	pF
Input Capacitance	$C_{iss}$	$V_{DS} = -15V, I_D = -2 mA, f = 1 MHz$		14	15	pF
Output Conductance	$g_{os}$	$V_{DG} = -15V, I_D = -2 mA$		100	300	$\mu mhos$
Noise Voltage	$e_n$	$V_{DG} = -15V, I_D = -2 mA, f = 100 Hz$		20		$nV/\sqrt{Hz}$

This process is available in the following device types. \*Denotes preferred parts.

**TO-18 (CASE 11)**

- 2N2609
- 2N5018
- 2N5019
- \*2N5114
- \*2N5115
- \*2N5116
- U301
- U304
- U305
- U306

**TO-72 (CASE 23)**

- 2N3382
- 2N3384
- 2N3386
- 2N3993
- 2N3993A
- 2N3994
- 2N3994A

**TO-92 (CASE 71)**

- P1086E
- P1087E

**TO-92 (CASE 74)**

- \*J174
- \*J175
- \*J176
- \*J177
- \*J270
- \*J271

**QUALIFIED PER MIL-S-19500**

- \*2N5114JAN, JANTX, JANTXV
- \*2N5115JAN, JANTX, JANTXV
- \*2N5116JAN, JANTX, JANTXV



Transfer Characteristics

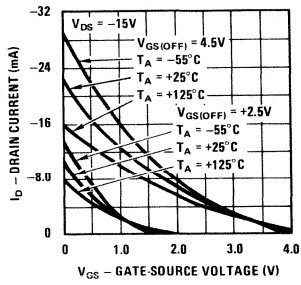

Parameter Interactions

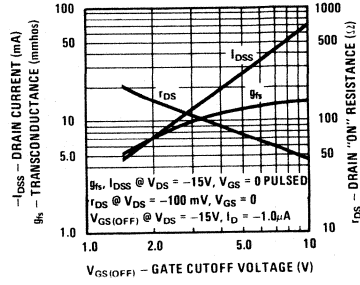

Common Drain-Source Characteristics

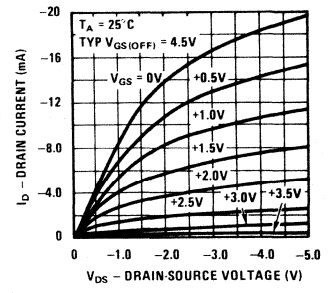

Transfer Characteristics

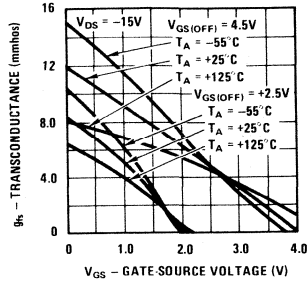

Leakage Current vs Voltage

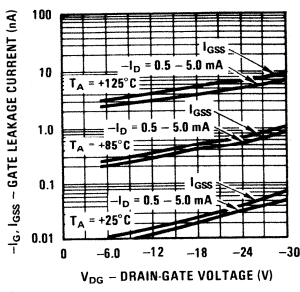

Channel Resistance vs Temperature

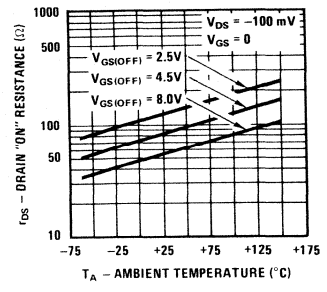

Output Conductance vs Drain Current

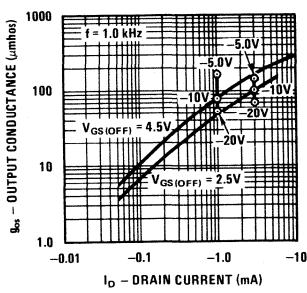

Transconductance vs Drain Current

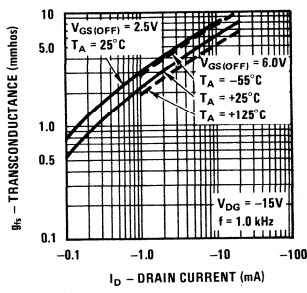

Noise Voltage vs Frequency

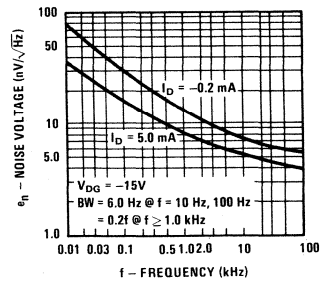

Capacitance vs Voltage

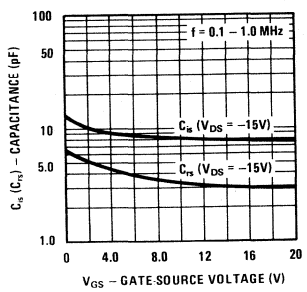

Normalized Drain Resistance vs Bias Voltage

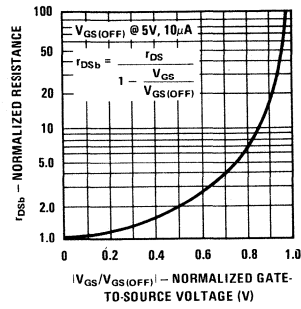



# Process 89 P-Channel JFET

## DESCRIPTION

Process 89 is designed primarily for low level amplifier applications. This device is the complement to Process 55. Commonly used in voltage variable resistor applications.

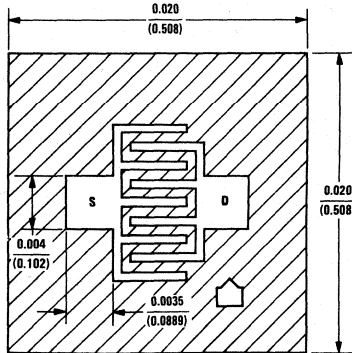

GATE IS BACKSIDE CONTACT

CHARACTERISTIC	PARAMETER	TEST CONDITIONS	MIN	TYP	MAX	UNITS
Gate-Source Breakdown Voltage	$BV_{GSS}$	$V_{DS} = 0V, I_G = 1 \mu A$	20	40		V
Zero Gate Voltage Drain Current	$I_{DSS}$	$V_{DS} = -15V, V_{GS} = 0$	-0.3	-4.0	-20	mA
Forward Transconductance	$g_{fs}$	$V_{DS} = -15V, V_{GS} = 0$	1.0	2.5	4.0	mmhos
Forward Transconductance	$g_{fs}$	$V_{DG} = -15V, I_D = -0.2 mA$		700		$\mu mhos$
Gate Leakage	$I_{GSS}$	$V_{GS} = 20V, V_{DS} = 0$		0.02	1.0	nA
Pinch Off Voltage	$V_{GS(OFF)}$	$V_{DS} = -15V, I_D = -1 nA$	0.5	3.0	9.0	V
Feedback Capacitance	$C_{rss}$	$V_{DG} = -15V, V_{GS} = 0, f = 1 MHz$		2.0	2.5	pF
Input Capacitance	$C_{is}$	$V_{DS} = -15V, I_D = -2 mA, f = 1 MHz$		7.0	8.5	pF
"ON" Resistance	$r_{DS}$	$V_{DS} = -100 mV, V_{GS} = 0$		450		$\Omega$
Output Conductance	$g_{os}$	$V_{DG} = -15V, I_D = -0.2 mA$		5.0	15	$\mu mhos$
Noise Voltage	$e_n$	$V_{DG} = -15V, I_D = -0.2 mA, f = 100 Hz$		30		$nV/\sqrt{Hz}$

This process is available in the following device types. \*Denotes preferred parts.

**TO-18 (CASE 11)**

2N2608  
2N4381  
2N5020  
2N5021

**TO-92 (CASE 71)**

\*2N5460  
\*2N5461  
\*2N5462  
PN4342  
PN4360  
PN5033

**TO-92 (CASE 74)**

2N3820

**QUALIFIED PER MIL-S-19500**

2N2608JAN

**TO-72 (CASE 23)**

2N3329  
2N3330  
2N3331  
2N3332

Transfer Characteristics

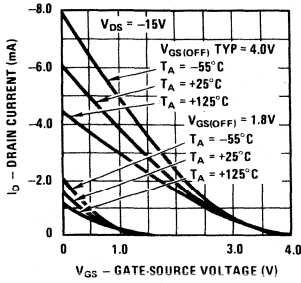

Parameter Interactions

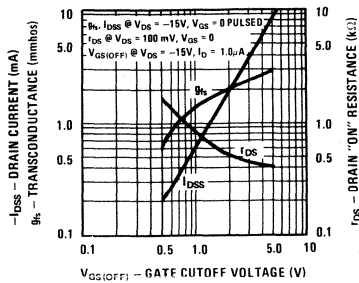

Common Drain-Source Characteristics

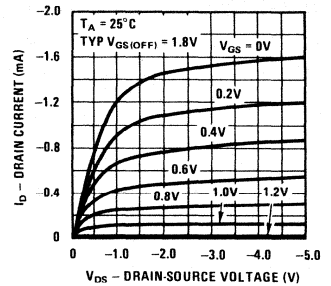

Transfer Characteristics

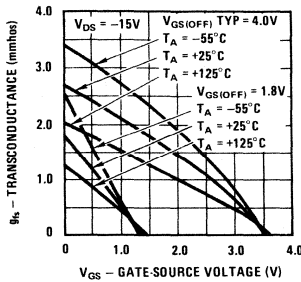

Leakage Current vs Voltage

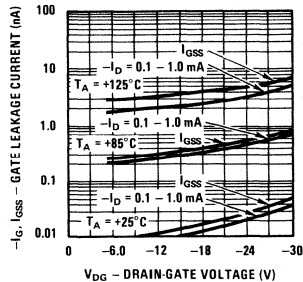

Channel Resistance vs Temperature

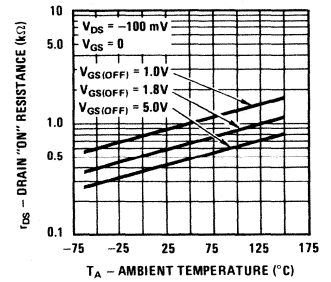

Output Conductance vs Drain Current

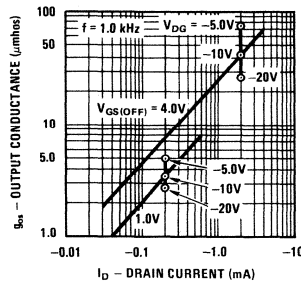

Transconductance vs Drain Current

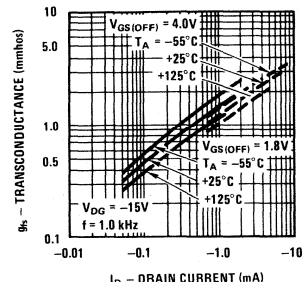

Noise Voltage vs Frequency

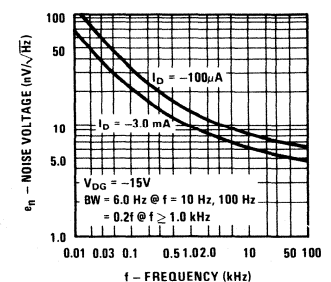

Capacitance vs Voltage

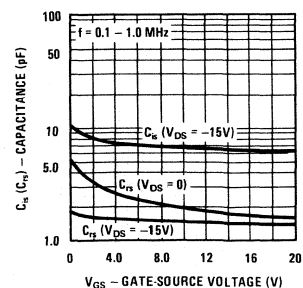



# Process 90 N-Channel JFET

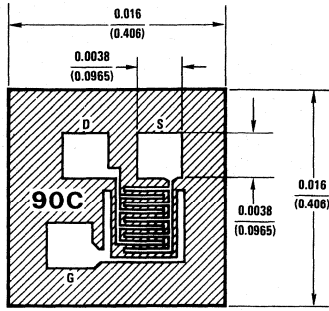

GATE IS ALSO BACKSIDE CONTACT

## DESCRIPTION

Process 90 is designed for VHF/UHF mixer/amplifier and applications where Process 50 is not adequate. Has sufficient gain and low noise, common gate configuration at 450 MHz, for sensitive receivers. The high transconductance and square law characteristics insures low crossmodulation and intermodulation distortions. Common-gate operation simplifies circuitry. Consider Process 92 for even higher performance.

CHARACTERISTIC	PARAMETER	TEST CONDITIONS	MIN	TYP	MAX	UNITS
Gate-Source Breakdown Voltage	$BV_{GSS}$	$V_{DS} = 0V, I_G = -1 \mu A$	-20	-30		V
Zero Gate Voltage Drain Current	$I_{DSS}$	$V_{DS} = 10V, V_{GS} = 0$	3	18	40	mA
Forward Transconductance	$g_{fs}$	$V_{DS} = 10V, V_{GS} = 0$	5.5	8.0	10	mmhos
Forward Transconductance	$g_{fs}$	$V_{DS} = 10V, I_D = 5 mA$	4.5	5.8		mmhos
Reverse Gate Current	$I_{GSS}$	$V_{GS} = -15V, V_{DS} = 0$	-5.0	-100		pA
"ON" Resistance	$r_{DS}$	$V_{DS} = 100 mV, V_{GS} = 0$		90		$\Omega$
Pinch Off Voltage	$V_{GS(OFF)}$	$V_{DS} = 10V, I_D = 1 nA$	-1.5	-3.5	-6.0	V
Output Conductance	$g_{os}$	$V_{DG} = 10V, I_D = 5 mA$		45	100	$\mu mhos$
Feedback Capacitance	$C_{fs}$	$V_{DG} = 10V, I_D = 5 mA$		1.0	1.2	pF
Input Capacitance	$C_{is}$	$V_{DG} = 10V, I_D = 5 mA$		4.0	5.0	pF
Noise Voltage	$e_n$	$V_{DG} = 10V, I_D = 5 mA, f = 100 Hz$		13		$nV/\sqrt{Hz}$
Noise Figure	NF	$V_{DG} = 10V, I_D = 5 mA, f = 450 MHz$		3.0		dB
Power Gain	$G_{pg} (CG)$	$V_{DG} = 10V, I_D = 5 mA, f = 450 MHz$		11		dB

This process is available in the following device types. \*Denotes preferred parts.

### TO-52 (CASE 07)

U312

### TO-72 (CASE 29)

\*2N5397  
2N5398

### TO-92 (CASE 72)

J114  
\*J210  
\*J211  
\*J212  
\*J300

### TO-92 (CASE 77)

\*2N5245  
\*2N5246  
\*2N5247

Common Drain-Source Characteristics

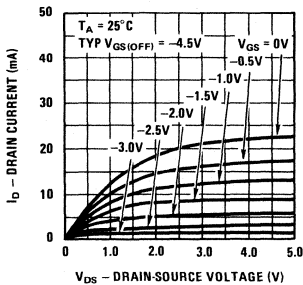

Parameter Interactions

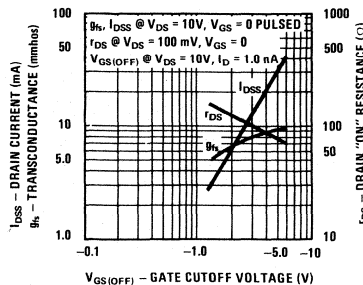

Transconductance vs Drain Current

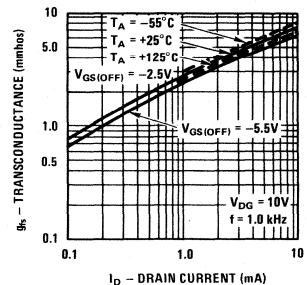

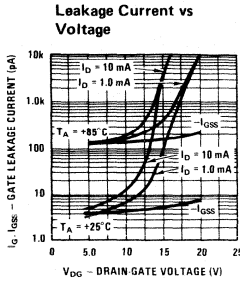
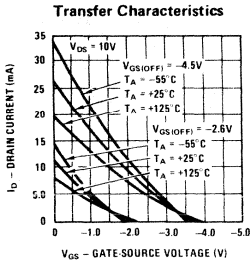

COMMON SOURCE

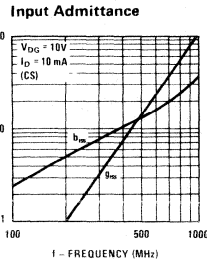

COMMON GATE

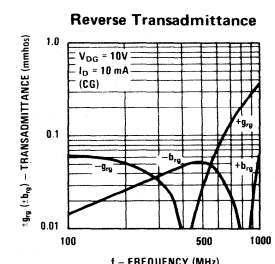
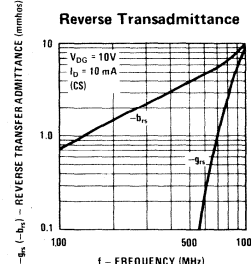
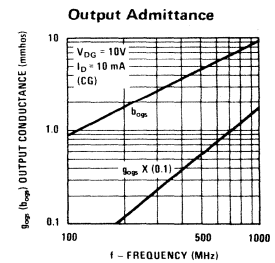
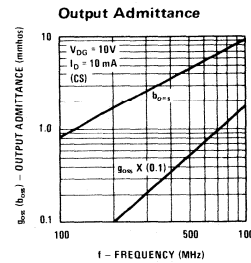
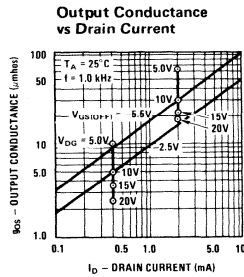
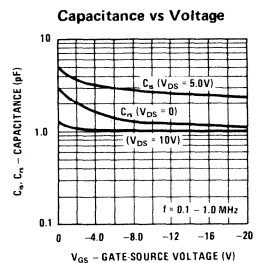
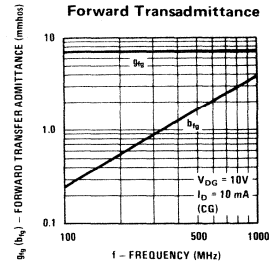
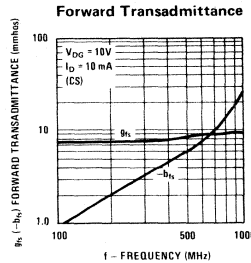
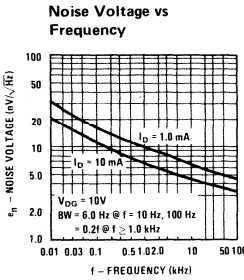
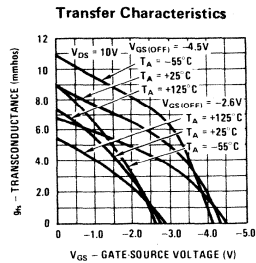
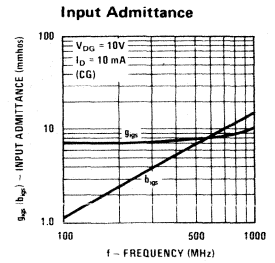



# Process 92 N-Channel JFET

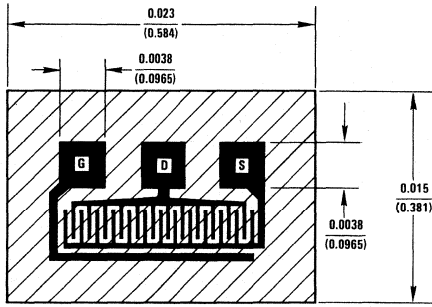

GATE IS ALSO BACKSIDE CONTACT

## DESCRIPTION

Process 92 is designed for VHF/UHF amplifier, oscillator, and mixer applications. As a common gate amplifier, 16 dB at 100 MHz and 12 dB at 450 MHz can be realized. Worst case 75 ohm input impedance provides ideal input match.

CHARACTERISTIC	PARAMETER	TEST CONDITIONS	MIN	TYP	MAX	UNITS
Gate-Source Breakdown Voltage	$BV_{GSS}$	$V_{DS} = 0V, I_G = -1 \mu A$	-20	-30		V
Zero Gate Voltage Drain Current	$I_{DSS}$	$V_{DS} = 10V, V_{GS} = 0$ , Pulsed	10	38	80	mA
Forward Transconductance	$g_{fs}$	$V_{DS} = 10V, V_{GS} = 0$ , Pulsed		19		mmhos
Forward Transconductance	$g_{fs}$	$V_{DG} = 10V, I_D = 10 \text{ mA}$	10	13	18	mmhos
Reverse Gate Current	$I_{GSS}$	$V_{GS} = -15V, V_{DS} = 0$		-15	-100	$\mu A$
"ON" Resistance	$r_{DS}$	$V_{DS} = 100 \text{ mV}, V_{GS} = 0$	35	45	80	$\Omega$
Pinch Off Voltage	$V_{GS(OFF)}$	$V_{DS} = 10V, I_D = 1 \text{ nA}$	-1.5	-4.0	-6.5	V
Output Conductance	$g_{os}$	$V_{DG} = 10V, I_D = 10 \text{ mA}$		160	250	$\mu mhos$
Feedback Capacitance	$C_{gd}$	$V_{DG} = 10V, I_D = 10 \text{ mA}, f = 1 \text{ MHz}$		2.0	2.5	pF
Input Capacitance	$C_{gs}$	$V_{DG} = 10V, I_D = 10 \text{ mA}, f = 1 \text{ MHz}$		4.1	5.0	pF
Noise Voltage	$e_n$	$V_{DG} = 10V, I_D = 10 \text{ mA}, f = 100 \text{ Hz}$		6.0		$nV/\sqrt{Hz}$
Noise Figure	NF	$V_{DG} = 10V, I_D = 10 \text{ mA}, f = 450 \text{ MHz}$		3.0		dB
Power Gain	$G_{pg}$	$V_{DG} = 10V, I_D = 10 \text{ mA}, f = 450 \text{ MHz}$		12		dB

This process is available in the following device types. \*Denotes preferred parts.

### TO-52 (CASE 07)

- U308
- \*U309
- \*U310

### TO-99 (CASE 24)

- U430
- U431

Dual

### TO-92 (CASE 72)

- J308
- \*J309
- \*J310

Parameter Interactions

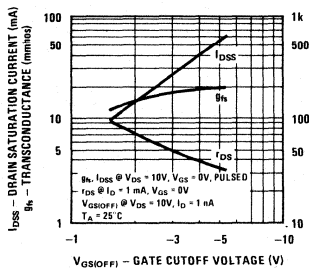

Transconductance vs Drain Current

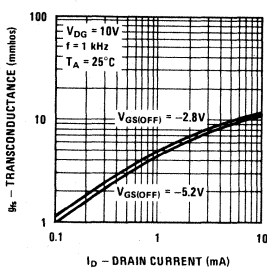

Leakage Current vs Voltage

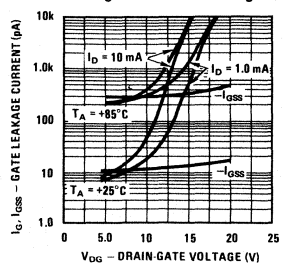

Transfer Characteristics

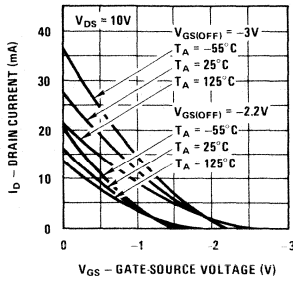

Transfer Characteristics

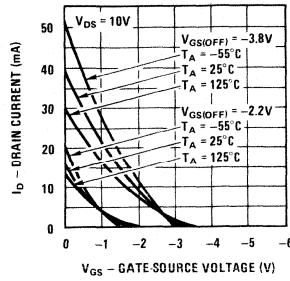

Input Admittance

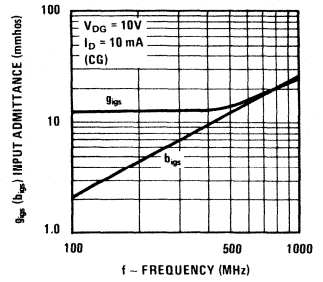

Transfer Characteristics

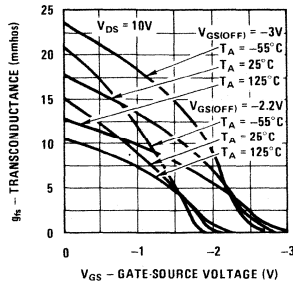

Transfer Characteristics

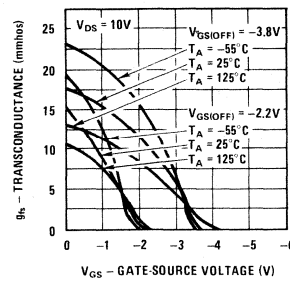

Forward Transmittance

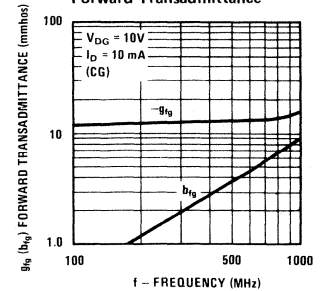

Common Drain-Source Characteristics

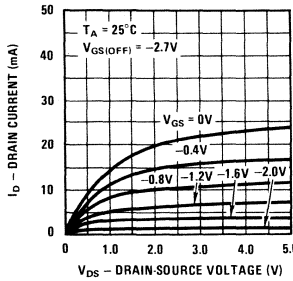

Output Conductance vs Drain Current

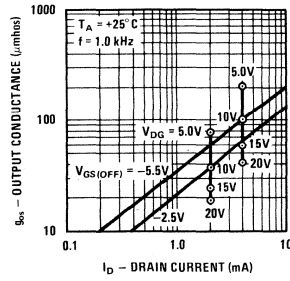

Output Admittance

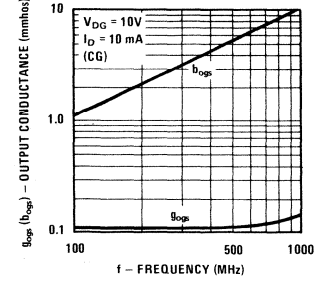

Capacitance vs Voltage

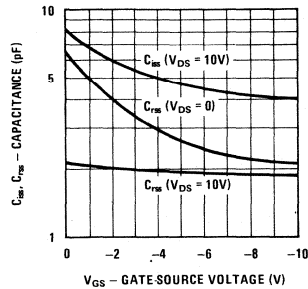

Noise Voltage vs Frequency

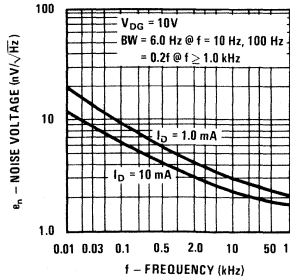

Reverse Transmittance

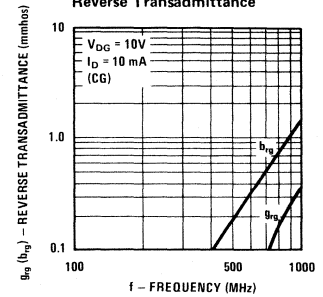



# Process 93 N-Channel Monolithic Dual JFET

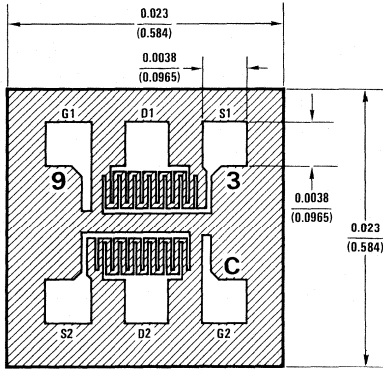

## DESCRIPTION

Process 93 is a monolithic dual JFET with a diode isolated substrate. It is intended for wide band, low noise, single ended video amplifier input stages, and high slew rate op amps. Monolithic structure eliminates thermal transient errors, and provides freedom to pick operating current and voltage.

CHARACTERISTIC	PARAMETER	TEST CONDITIONS	MIN	TYP	MAX	UNITS
Gate-Source Breakdown Voltage	$BV_{GSS}$	$V_{DS} = 0V, I_G = -1 \mu A$	-25	-30		V
Zero Gate Voltage Drain Current	$I_{DSS}$	$V_{DS} = 10V, V_{GS} = 0, \text{ Pulsed}$	3.0	18	40	mA
Forward Transconductance	$g_{fs}$	$V_{DS} = 10V, V_{GS} = 0, \text{ Pulsed}$		8.0		mmhos
Forward Transconductance	$g_{fs}$	$V_{DG} = 10V, I_D = 5 \text{ mA}$	5.0	6.0	10	mmhos
Output Conductance	$g_{os}$	$V_{DG} = 10V, I_D = 5 \text{ mA}$		50	100	$\mu\text{mhos}$
Pinch Off Voltage	$V_{GS(OFF)}$	$V_{DS} = 10V, I_D = 1 \text{ nA}$	-1.5	-3.5	-6.0	V
"ON" Resistance	$r_{DS}$	$V_{DS} = 100 \text{ mV}, V_{GS} = 0$		100		$\Omega$
Gate Current	$I_G$	$V_{DG} = 10V, I_D = 5 \text{ mA}$		10	100	pA
Noise Voltage	$e_n$	$V_{DG} = 10V, I_D = 5 \text{ mA}, f = 100 \text{ Hz}$		9.0	30	$\text{nV}/\sqrt{\text{Hz}}$
Differential Match	$ V_{GS1} - V_{GS2} $	$V_{DG} = 10V, I_D = 5 \text{ mA}$		9.0	30	mV
Differential Match	$\Delta V_{GS1-2}$	$V_{DG} = 10V, I_D = 5 \text{ mA}$		15	40	$\mu\text{V}/^\circ\text{C}$
Common Mode Rejection	CMRR	$V_{DG} = 10V, I_D = 5 \text{ mA}$		90		dB
Feedback Capacitance	$C_{rs}$	$V_{DG} = 10V, I_D = 5 \text{ mA}, f = 1 \text{ MHz}$		1.0	1.2	pF
Input Capacitance	$C_{is}$	$V_{DG} = 10V, I_D = 5 \text{ mA}, f = 1 \text{ MHz}$		4.2	5.0	pF

This process is available in the following device types. \*Denotes preferred parts.

### TO-78 (CASE 24)

- \*2N5911
- \*2N5912
- U257

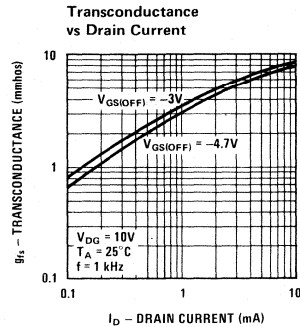
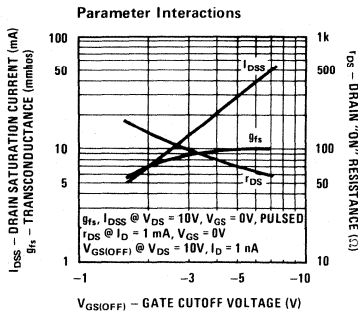



Transfer Characteristics

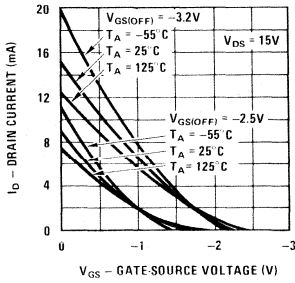

Transfer Characteristics

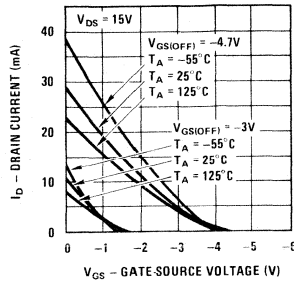

Common Drain-Source Characteristics

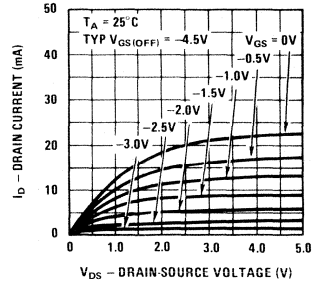

Transfer Characteristics

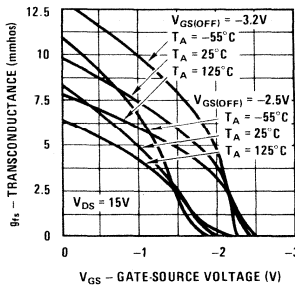

Transfer Characteristics

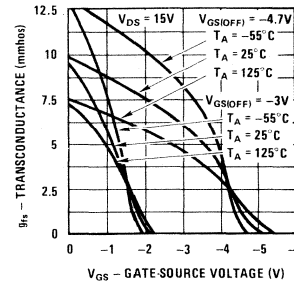

Leakage Current vs Voltage

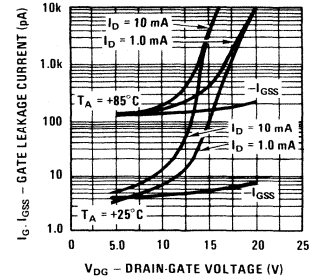

Output Conductance vs Drain Current

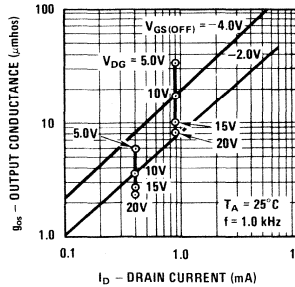

Noise Voltage vs Frequency

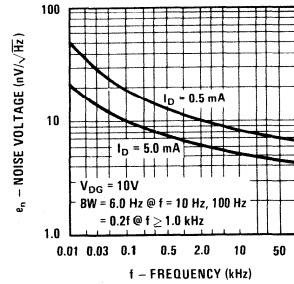

Capacitance vs Voltage

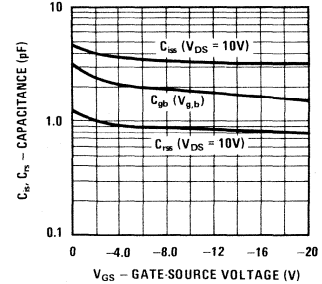

Differential Offset

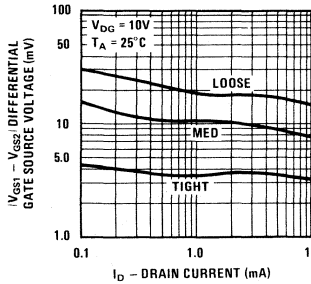

Differential Drift

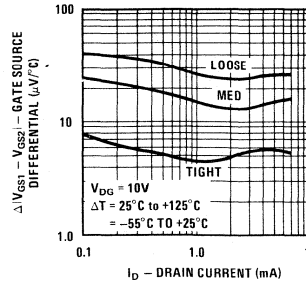

CMRR vs Drain Current

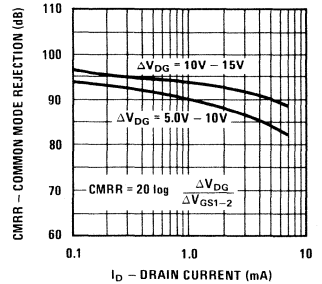



# Process 94 N-Channel Monolithic Dual JFET

## DESCRIPTION

Process 94 is a monolithic dual JFET. It is strictly intended for operational amplifier input buffer applications. Special processing results in extremely low input bias current and virtually unmeasurable offset current. It is important to note that the <5 pico ampere bias current is measured at 35 volts. Typical CMRR is 125 dB. Performance superior to electrometer tubes can be readily achieved with low offset voltage and almost zero long term drift.

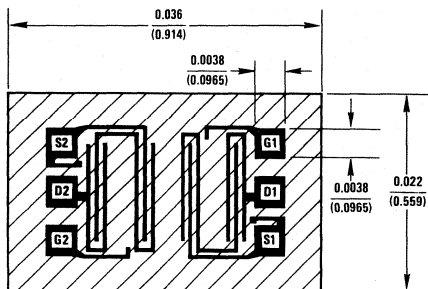

CHARACTERISTIC	PARAMETER	TEST CONDITIONS	MIN	TYP	MAX	UNITS
Gate-Source Breakdown Voltage	$BV_{GSS}$	$V_{DS} = 0V, I_G = -1 \mu A$	-40	-70		V
Zero Gate Voltage Drain Current	$I_{DSS}$	$V_{DS} = 15V, V_{GS} = 0$	0.5	3.0	10	mA
Forward Transconductance	$g_{fs}$	$V_{DS} = 15V, V_{GS} = 0$	1.5	3.5	7.0	mmho
Forward Transconductance	$g_{fs}$	$V_{DG} = 15V, I_D = 0.2 mA$	0.9	1.2	1.8	mmhos
Pinch Off Voltage	$V_{GS(OFF)}$	$V_{DS} = 15V, I_D = 1 nA$	-0.5	-2.0	-6.0	V
Gate Current	$I_G$	$V_{DG} = 35V, I_D = 0.20 mA$		1.0	15	pA
Feedback Capacitance	$C_{rss}$	$V_{DS} = 15V, V_{GS} = 0, f = 1 MHz$		0.01	0.02	pF
Input Capacitance	$C_{iss}$	$V_{DS} = 15V, V_{GS} = 0, f = 1 MHz$		4.0	5.0	pF
Noise Voltage	$e_n$	$V_{DG} = 15V, I_D = 0.2 mA, f = 10 Hz$		12	50	$nV/\sqrt{Hz}$
Output Conductance	$g_{os}$	$V_{DG} = 15V, I_D = 0.2 mA$		<0.1		$\mu mhos$
Differential Match	$ V_{GS1} - V_{GS2} $	$V_{DG} = 15V, I_D = 0.2 mA$		5.0	25	mV
Differential Match	$\Delta V_{GS1-2}$	$V_{DG} = 15V, I_D = 0.2 mA$		6.0	50	$\mu V/^\circ C$
Common Mode Rejection	CMRR	$V_{DG} = 15V, I_D = 0.2 mA$		125		dB

This process is available in the following device types.

\*Denotes preferred parts.

### TO-71 (CASE 12)

- \*NDF9406
- \*NDF9407
- \*NDF9408
- \*NDF9409
- \*NDF9410

### TO-78 (CASE 24)

- NDF9401
- NDF9402
- NDF9403
- NDF9404
- NDF9405

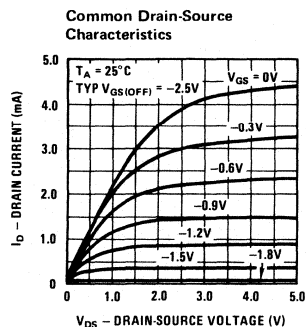
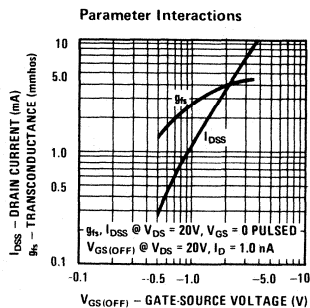

**Transfer Characteristics**

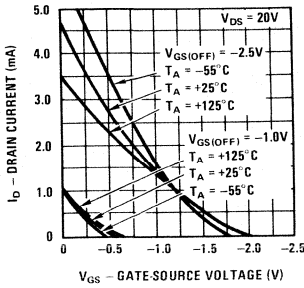

**Leakage Current vs Voltage**

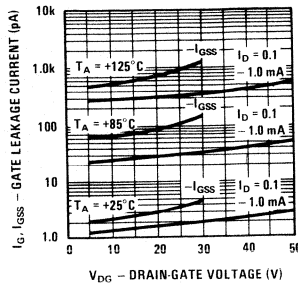

**Output Conductance vs Drain Current**

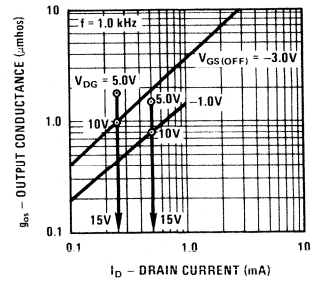

**Transfer Characteristics**

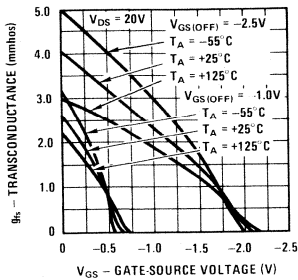

**Transconductance vs Drain Current**

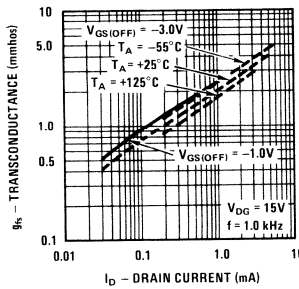

**Capacitance vs Voltage**

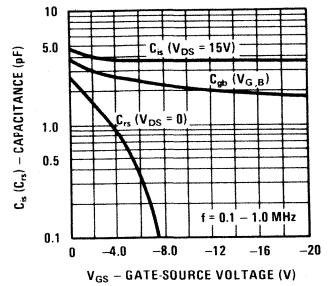

**Noise Voltage vs Frequency**

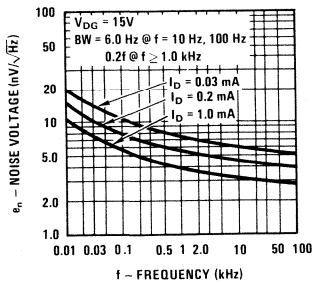

**Noise Voltage vs Current**

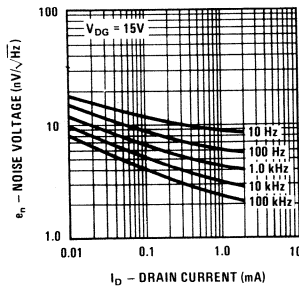

**Differential Offset**

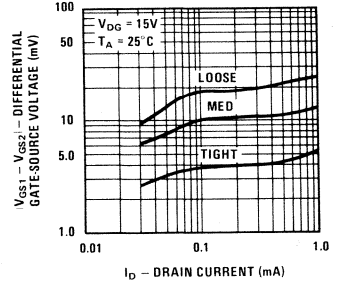

**Differential Drift**

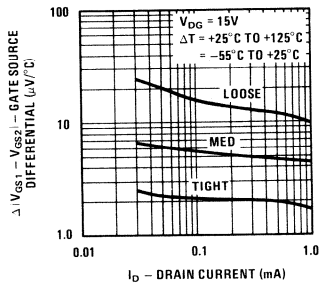

**CMRR vs Drain Current**

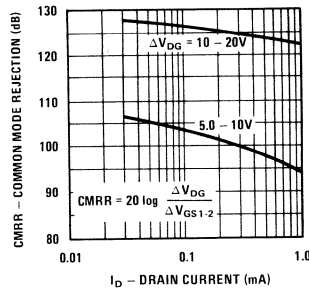



# Process 95 N-Channel Monolithic Dual JFET

## DESCRIPTION

Process 95 is a monolithic dual JFET with a diode isolated substrate. It is intended for operational amplifier input buffer applications. Processing results in low input bias current and virtually unmeasurable offset current. Low noise voltage and high CMRR for critical I/f applications.

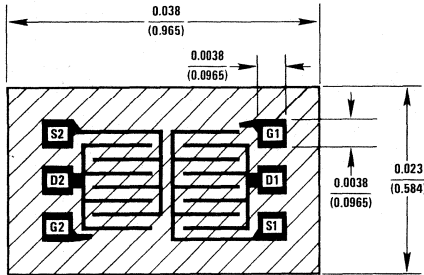

CHARACTERISTIC	PARAMETER	TEST CONDITIONS	MIN	TYP	MAX	UNITS
Gate-Source Breakdown Voltage	$BV_{GSS}$	$V_{DS} = 0V, I_G = -1 \mu A$	-40	-70		V
Zero Gate Voltage Drain Current	$I_{DSS}$	$V_{DS} = 15V, V_{GS} = 0$	0.5	3.0	8.0	mA
Forward Trans-conductance	$g_{fs}$	$V_{DS} = 15V, V_{GS} = 0$	1.0	2.5	4.0	mmhos
Forward Trans-conductance	$g_{fs}$	$V_{DG} = 15V, I_D = 0.2 mA$	0.5	0.7		mmhos
Gate Leakage	$I_{GSS}$	$V_{GS} = -20V, V_{DS} = 0$		-5.0	-100	$\mu A$
Pinch Off Voltage	$V_{GS(OFF)}$	$V_{DS} = 15V, I_D = 1 nA$	-0.5	-2.5	-4.0	V
Input Capacitance	$C_{iss}$	$V_{DS} = 15V, V_{GS} = 0, f = 1 MHz$		10	14	pF
Noise Voltage	$e_n$	$V_{DS} = 15V, I_D = 0.2 mA, f = 10 Hz$		8.0	30	$nV/\sqrt{Hz}$
Noise Voltage	$e_n$	$V_{DS} = 15V, I_D = 0.2 mA, f = 100 Hz$		6.0	10	$nV/\sqrt{Hz}$
Output Conductance	$g_{os}$	$V_{DG} = 15V, I_D = 0.2 mA$		0.3	1.0	$\mu mhos$
Feedback Capacitance	$C_{rss}$	$V_{DS} = 15V, V_{GS} = 0, f = 1 MHz$		3.5	5.0	pF
Differential Match	$ V_{GS1} - V_{GS2} $	$V_{DG} = 20V, I_D = 0.2 mA$		6.0	25	mV
Differential Match	$\Delta V_{GS1-2}$	$V_{DG} = 20V, I_D = 0.2 mA$		9.0	60	$\mu V/^\circ C$
Common Mode Rejection	CMRR	$V_{DG} = 20V, I_D = 0.2 mA$	86	115		dB

This process is available in the following device types. \*Denotes preferred parts.

### TO-71 (CASE 12)

2N5515	*2N5522
2N5516	*2N5523
2N5517	*2N5524
2N5518	*2N6483
2N5519	*2N6484
*2N5520	*2N6485
*2N5521	

Transfer Characteristics

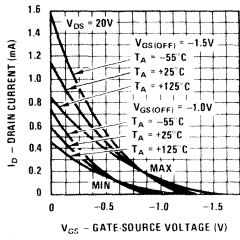

Transfer Characteristics

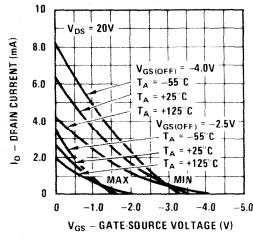

Common Drain-Source Characteristics

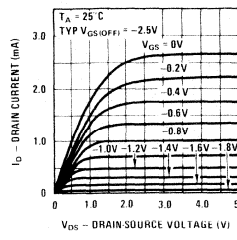

Parameter Interactions

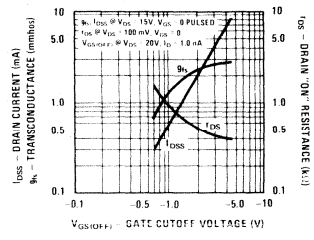

Transconductance Characteristics

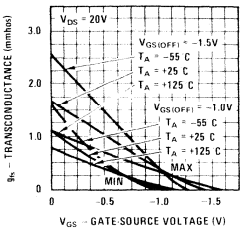

Transconductance Characteristics

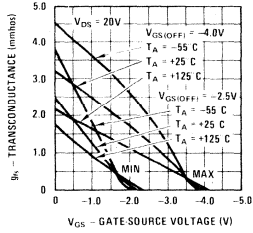

Channel Resistance vs Temperature

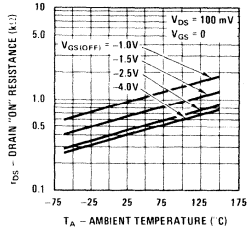

Leakage Current vs Voltage

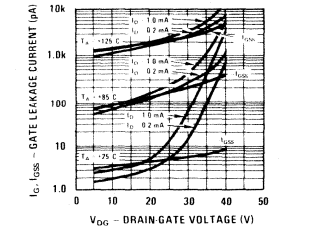

Output Conductance vs Drain Current

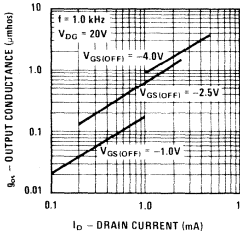

Transconductance vs Drain Current

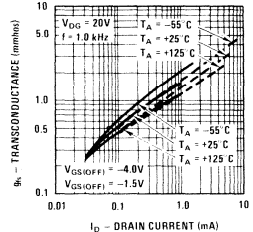

Noise Voltage vs Frequency

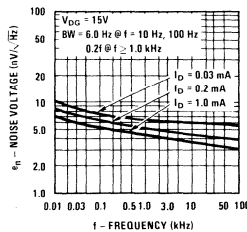

Noise Voltage vs Current

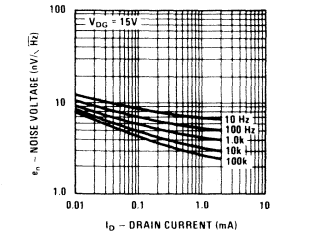

Capacitance vs Voltage

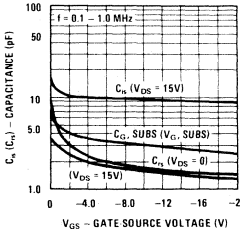

Differential Offset

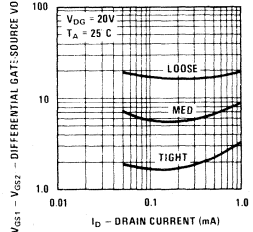

Differential Drift

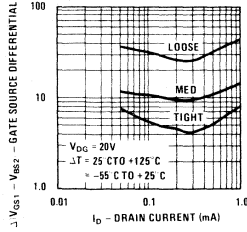

CMRR vs Drain Current

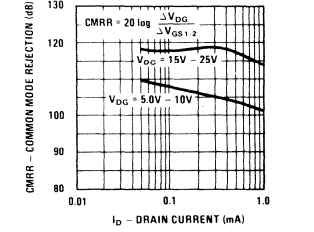



# Process 96 N-Channel Monolithic Dual JFET

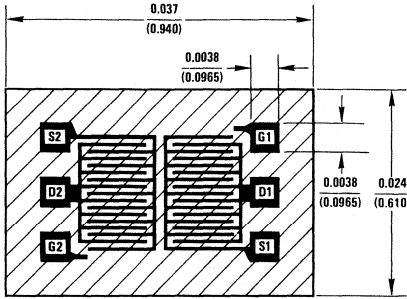

## DESCRIPTION

Process 96 is a monolithic dual JFET with a diode isolated substrate. It is intended for wide band, low noise, single ended video amplifier input stages. Also ideal for matched voltage variable resistor applications over 60 dB tracking range.

CHARACTERISTIC	PARAMETER	TEST CONDITIONS	MIN	TYP	MAX	UNITS
Gate-Source Breakdown Voltage	$BV_{GSS}$	$V_{DS} = 0V, I_G = -1 \mu A$	-40	-55		V
Zero Gate Voltage Drain Current	$I_{DSS}$	$V_{DS} = 15V, V_{GS} = 0$	5.0	15	30	mA
Forward Transconductance	$g_{fs}$	$V_{DS} = 15V, V_{GS} = 0$	9.0	18	30	mmhos
Forward Transconductance	$g_{fs}$	$V_{DG} = 15V, I_D = 2 mA$	7.5	9.0		mmhos
Output Conductance	$g_{os}$	$V_{DG} = 15V, I_D = 2 mA$		15	45	$\mu$ mhos
Pinch Off Voltage	$V_{GS(OFF)}$	$V_{DS} = 15V, I_D = 1 nA$		-1.8	-3.0	V
"ON" Resistance	$r_{DS}$	$V_{DS} = 100 mV, V_{GS} = 0$	35	70	120	$\Omega$
Gate Current	$I_{GSS}$	$V_{GS} = -20V, V_{DS} = 0$		-8.0	-100	$\mu$ A
Gate Current	$I_G$	$V_{DG} = 15V, I_D = 2 mA$		15	200	$\mu$ A
Noise Voltage	$e_n$	$V_{DG} = 15V, I_D = 2 mA, f = 100 Hz$		4.5	10	$nV/\sqrt{Hz}$
Feedback Capacitance	$C_{rs}$	$V_{DG} = 15V, I_D = 2 mA, f = 1 MHz$		2.5	3.0	pF
Input Capacitance	$C_{is}$	$V_{DG} = 15V, I_D = 2 mA, f = 1 MHz$		10	12	pF
Differential Voltage	$ V_{GS1} - V_{GS2} $	$V_{DG} = 15V, I_D = 2 mA$		8.0	25	mV
Differential Voltage	$\Delta V_{GS}$	$V_{DG} = 15V, I_D = 2 mA$		9.0	50	$\mu V/^\circ C$
Common Mode Rejection	CMRR	$V_{DG} = 15V, I_D = 2 mA$	76	95		dB

This process is available in the following device types. \* Denotes preferred parts.

### TO-71 (CASE 12)

- \*2N5564
- \*2N5565
- \*2N5566

### 8-Pin DIP (CASE 67)

- \*NPD5564
- \*NPD5565
- \*NPD5566

Parameter Interactions

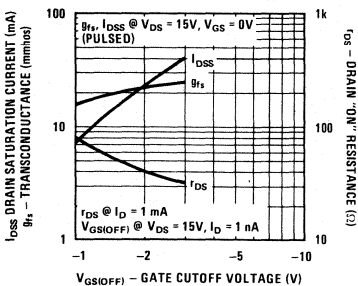

Transconductance vs Drain Current

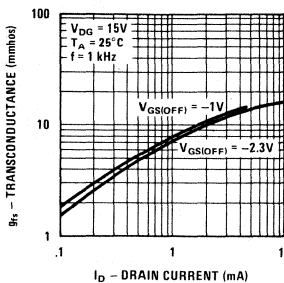

Leakage Current vs Voltage

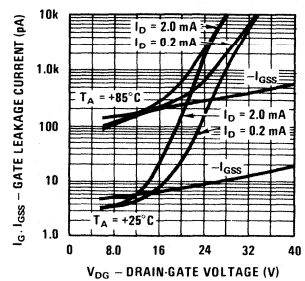

Transfer Characteristics

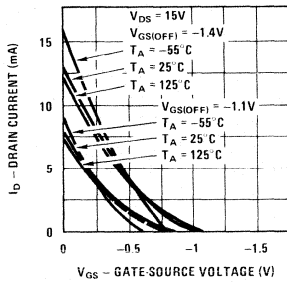

Transfer Characteristics

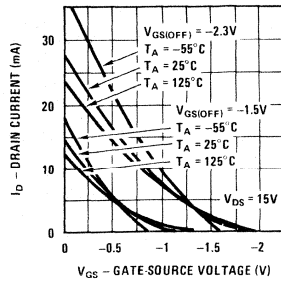

Common Drain-Source Characteristics

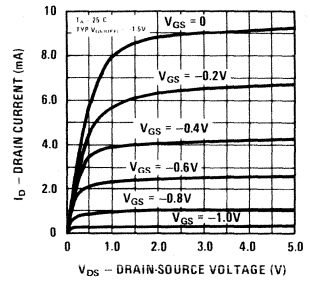

Transfer Characteristics

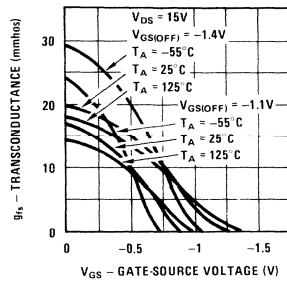

Transfer Characteristics

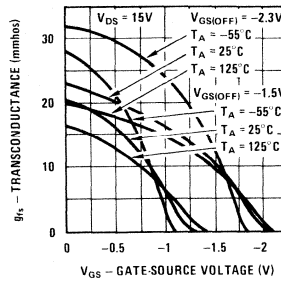

Output Conductance vs Drain Current

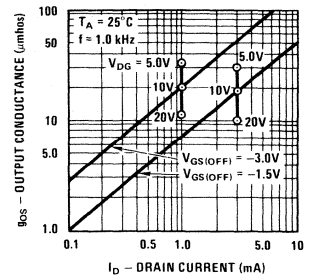

Noise Voltage vs Current

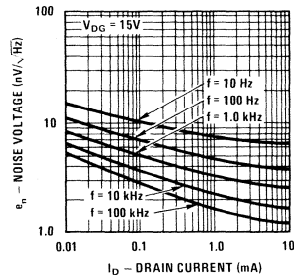

Noise Voltage vs Frequency

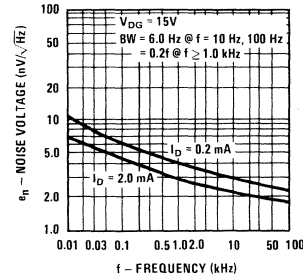

Capacitance vs Voltage

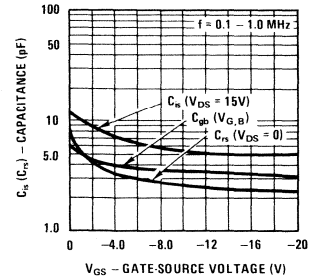

Differential Offset

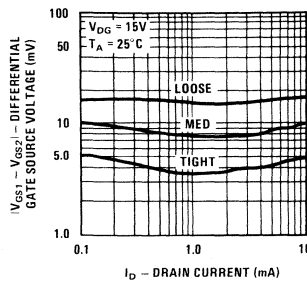

Differential Drift

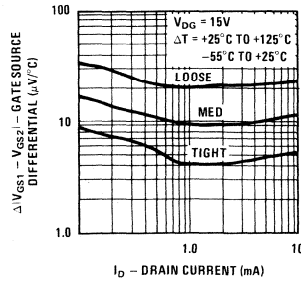

CMRR vs Drain Current

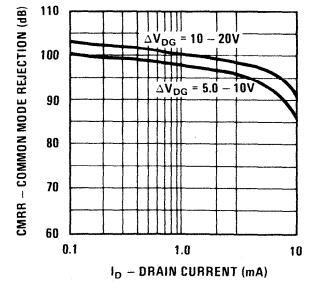



# Process 98 N-Channel JFET

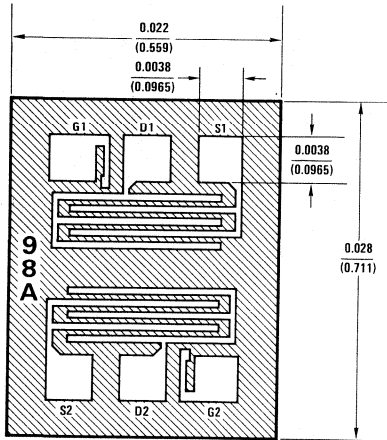

## DESCRIPTION

Process 98 is a high gain, general purpose, monolithic dual JFET with a diode isolated substrate. It is intended for amplifier input stages requiring high gain, low noise and low offset drift over temperature. Strict processing controls result in low input bias currents and virtually immeasurable offset currents. Matching characteristics are essentially independent of operating current and voltage.

This process is available in the following device types.  
\* Denotes preferred parts.

### TO-71 (CASE 12)

2N5561  
2N5562  
2N5563  
U401  
U402  
U403  
U404  
U405  
U406

### 8-Pin DIP (CASE 60)

J401  
J402  
J403  
J404  
J405  
J406

**PROCESS IN DEVELOPMENT**





**National Semiconductor Corporation**

2900 Semiconductor Drive  
Santa Clara, California 95051  
Tel. (408) 737-5000  
Telex (910) 339-9240

**National Semiconductor GmbH**

Eisenheimerstr. 61/2  
8000 München 21  
West Germany  
Tel. (089) 576091  
Telex 522772

Ferdinandsplatz 11  
6380 Bad Homburg  
Tel. (06172) 23011  
Telex 415887

Hohenheimer Str. 11  
7022 Leinfelden-Stuttgart  
Tel. (0711) 751057  
Telex 7255746

Döckenhudener Str. 29  
2000 Hamburg 55  
Tel. (040) 868457  
Telex 211039

**NS International Inc., Japan**

Miyake Building  
1-9 Yotsuya, Shinjuku-ku 160  
Tokyo, Japan  
Tel. (03) 355-3711  
Telex 232-2015 NSCJHJ

**NS Electronics (Hong Kong) Ltd.**

8th Floor,  
Cheung Kong Electronic Bldg  
4 Hing Yip Street  
Kwun Tong  
Kowloon, Hong Kong  
Tel. 3-411241-8  
Telex 73866 NSEHK HX  
Cable NATSEMI

**NS Electronics Do Brasil**

Avda Brigadero Faria Lima 844  
11 Andar, Conjunto 1104  
Jardim Paulistano  
Sao Paulo, Brasil  
Telex 1121008 CABINE SAO PAULO

**NS Electronics Pty. Ltd.**

Chr. Stud Rd. & Mtn. Highway  
Bayswater, Victoria 3153  
Australia  
Tel. 03-729-6333  
Telex 32096

**National Semiconductor France**

Expansion 10000  
28, rue de la Redoute  
92260 Fontenay-aux-Roses  
France  
Tel. 660.81.40  
Telex NSF 25956F+

**National Semiconductor**

789 Ave. Houba de Strooper,  
1020 Bruxelles  
Benelux  
Tel. (02) 4783400  
Telex 61007

**National Semiconductor SRL**

Via Alberto Mario 26  
20149 Milano  
Italy  
Tel. (02) 4692864-4692431  
Telex 39835

**Mexicana de Electronica**

Industrial S.A.  
Tiacoquemecati No. 139-401  
Esq.uma Adolfo Prieto  
Mexico 12, D.F.  
Tel. 575-78-68, 575-79-24

**National Semiconductor (Pty.) Ltd.**

No. 1100 Lower Delta Road  
Singapore 3  
Tel. 2700011  
Telex NAT SEMI RS 21402

**National Semiconductor Sweden**

Alqrytevägen 23  
S-12732 Skarholmen  
Sweden  
Tel. (8) 970835  
Telex 10731

**National Semiconductor Ltd.**

Vodroffsvej 44  
1900 Copenhagen V  
Denmark  
Tel. (01) 356533  
Telex 15179

**NS Electronics (HK) Ltd.**

Taiwan Liaison Office  
Rm. B, 3rd Fl., Ching Lin Bldg  
#5-7, Chung Tao E. Road  
P.O. Box 68-332 Taipei  
Tel. 3917324-6  
Telex 22837 NSTW  
Cable NSTW TAIPEI

**National Semiconductor (UK) Ltd.**

19 Goldington Road  
Bedford, MK 403 LF  
United Kingdom  
Tel. (0234) 211262  
Telex 826209

**National Semiconductor**

District Sales Office  
345 Wilson Avenue, Suite 404  
Downsview, Ontario M3H 5W1  
Canada  
Tel. (416) 635-7260

**National Semiconductor**

Korea Liaison Office  
Rm. 607-615, 619 Seoul Bldg  
8,2 KA Haebyeol Dong  
Jung-ku  
Seoul, Korea  
Tel. 20-2925